



CARLISLE BRASS

TRANSFORMING ARCHITECTURAL IRONMONGERY





EN 1165

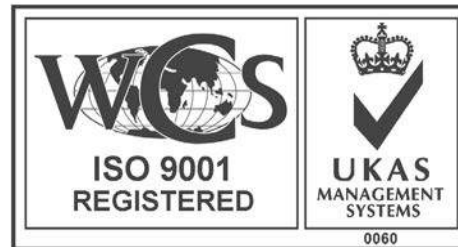

Certificate No. 7287

Carlisle Brass is an ISO 14001:2004 and ISO 9001:2008 accredited company.

In 2014 we sold £37 million of hardware including more than 2,100,000 door knobs and handles!

Since 1986 we have designed, sourced and distributed our own brands to architectural ironmongers, builders merchants and new build developers.

We are one of the few UK companies that still produce hinges, locks and emergency exit hardware in our own CE, BSI and Certifire approved factory. Our in house cylinder shop provides rapid turnaround of master key, keyed alike and specialist locking options.

We are specified as standard by all top 10 new home developers in the UK, and with 39 of the top 50!



 **CARLISLE BRASS**
TRANSFORMING ARCHITECTURAL IRONMONGERY

 **EUROSPEC**

Carlisle Brass is the UK's largest specialised developer of door and window hardware for residential and commercial properties.

Tel: 01228 511030
Web: www.carlislebrass.com

Eurospec is the brand used for all our technical products mainly used in commercial applications.

Accredited products in this range are stringently tested to ensure they comply to the latest regulations.

OUR BRANDS

SEROZZETTA
©
CARLISLE BRASS

Influenced by European styles this broad range of door and window furniture has been designed in the UK to suit the modern domestic home.

DELAMAIN
©
CARLISLE BRASS

Traditional mortice knobs and accessories influenced by the French regency period. Constructed using high quality brass and luxury materials including crystal and porcelain.



OUR BRANDS

LUDLOW
©
CARLISLE BRASS

Our period range of traditionally crafted hand-made black antique, pewter and beeswax finishes that are the perfect way to create an aged look in your property.



DE L'EAU
©
CARLISLE BRASS

Beautifully crafted bathroom range that features a number of designs to suit most domestic applications where a chrome or stainless steel finish is required.

FINGERTIP
©
CARLISLE BRASS

Contemporary and traditional ranges of cabinet hardware in a wide variety of finishes that utilise materials such as crystal, pewter and porcelain in their designs.

CONTENTS



**Door Furniture including
Aluminium Range
and Ludlow Ranges
5**



**Cylinders
357**



**Hinges
299**



**Locks and Latches
383**



**Door Controls
323**



**Window Fittings
407**



**Panic Hardware
346**



**Bathroom Fittings
423**



**Intumescent Fire
Protection and Acoustic
Sealing Systems
351**







**Cabinet Hardware
445**





Designer Levers on Press on Rose



SEROZZETTA





	   	<p>SZC010</p> <p>UNO Lever on Round Rose Concealed Fix Press-on-Rose</p> <p>Dimensions (mm): Rose: 51 Dia. Rose Thickness: 8 Projection: 67 Lever Length: 109</p> <p><input type="checkbox"/> CP <input type="checkbox"/> SC</p>
-----------------------------------------------------------------------------------	-----------------------------------------------------------------------------------------------------------------------------------------------------------------------------------------------------------------------------------------------------------------------------------------------------------------------------------------	-------------------------------------------------------------------------------------------------------------------------------------------------------------------------------------------------------------------------------------------------------------------------------

	   	<p>SZC020</p> <p>DOS Lever on Round Rose Concealed Fix Press-on-Rose</p> <p>Dimensions (mm): Rose: 51 Dia. Rose Thickness: 8 Projection: 73 Lever Length: 111</p> <p><input type="checkbox"/> CP <input type="checkbox"/> SC</p>
------------------------------------------------------------------------------------	-----------------------------------------------------------------------------------------------------------------------------------------------------------------------------------------------------------------------------------------------------------------------------------------------------------------------------------------	-------------------------------------------------------------------------------------------------------------------------------------------------------------------------------------------------------------------------------------------------------------------------------

	   	<p>SZC030</p> <p>TRES Lever on Round Rose Concealed Fix Press-on-Rose</p> <p>Dimensions (mm): Rose: 51 Dia. Rose Thickness: 8 Projection: 67 Lever Length: 114</p> <p><input type="checkbox"/> CP <input type="checkbox"/> SC</p>
-------------------------------------------------------------------------------------	-------------------------------------------------------------------------------------------------------------------------------------------------------------------------------------------------------------------------------------------------------------------------------------------------------------------------------------------------	--------------------------------------------------------------------------------------------------------------------------------------------------------------------------------------------------------------------------------------------------------------------------------

SEROZZETTA













SZC040

CUATRO
Lever on Round Rose
Concealed Fix Press-on-Rose

Dimensions (mm):
Rose: 51 Dia.
Rose Thickness: 8
Projection: 67
Lever Length: 110

CP SC













SZC050

CINCO
Lever on Round Rose
Concealed Fix Press-on-Rose

Dimensions (mm):
Rose: 51 Dia.
Rose Thickness: 8
Projection: 67
Lever Length: 110

CP SC



SZC330

TREINTA
Lever on Round Rose
Concealed Fix Press-on-Rose

Dimensions (mm):
Rose: 51 Dia.
Rose Thickness: 8
Projection: 61
Lever Length: 117

CP SC

Serozzetta levers are supplied with bolt through fixings and should be used in conjunction with BTL's on P389. and Eurospec locks. For matching escutcheons SZC001-3 see P8. For matching bathroom turn SZC004 see P8.

SEROZZETTA



SZC340

CUARENTA

Lever on Round Rose
Concealed Fix Press-on-Rose

Dimensions (mm):

Rose:	51 Dia.
Rose Thickness:	8
Projection:	63
Lever Length:	123



SZC001/2/3

ESCUTCHEON

Concealed Fix
Press-on-Rose

Dimensions (mm):

Rose:	51 Dia.
Rose Thickness:	10

SZC001	Euro
SZC002	Oval
SZC003	Lock



SZC004

THUMBTURN AND RELEASE

Concealed Fix
Press-on-Rose

Dimensions (mm):

Rose:	51 Dia.
Rose Thickness:	10



Designer Levers on Screw on Rose



SEROZZETTA

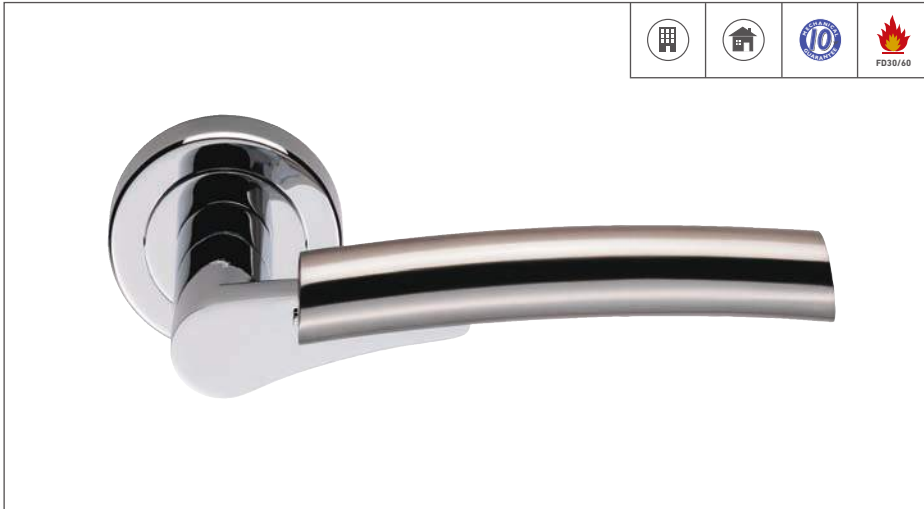

SZM014

VALIANT

Lever on Round Rose
Concealed Fix 2 Part Screw-on-Rose

Dimensions (mm):

Rose:	51 Dia.
Rose Thickness:	10
Projection:	60
Lever Length:	128
Bar:	18 Dia.

 **CPSN**

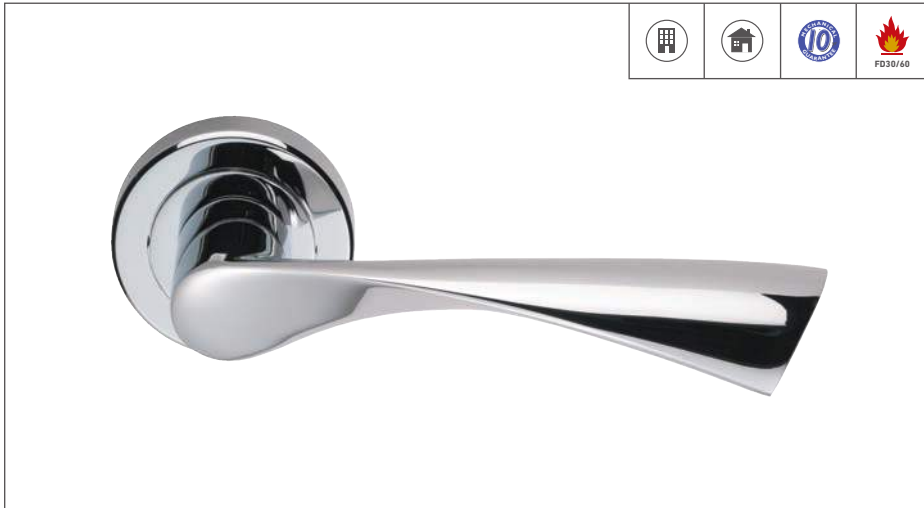

SZM025

BREEZE

Lever on Round Rose
Concealed Fix 2 Part Screw-on-Rose

Dimensions (mm):

Rose:	51 Dia.
Rose Thickness:	10
Projection:	74
Lever Length:	126

 **CP**



SZM026

VOGUE

Lever on Round Rose
Concealed Fix 2 Part Screw-on-Rose





Dimensions (mm):

Rose:	51 Dia.
Rose Thickness:	10
Projection:	66
Lever Length:	135

 **CP**  **CPSN**

SEROZZETTA













SZM100

LUNA
Lever on Round Rose
Concealed Fix 2 Part Screw-on-Rose

Dimensions (mm):
Rose: 51 Dia.
Rose Thickness: 10
Projection: 57
Lever Length: 122

CP SC













SZM110

AZUL
Lever on Round Rose
Concealed Fix 2 Part Screw-on-Rose

Dimensions (mm):
Rose: 51 Dia.
Rose Thickness: 10
Projection: 65
Lever Length: 139
Bar: 20 Dia.

SCCP



SZM130

STYLE
Lever on Round Rose
Concealed Fix 2 Part Screw-on-Rose





Dimensions (mm):
Rose: 51 Dia.
Rose Thickness: 10
Projection: 63
Lever Length: 110

CP SC

Serozzetta levers are supplied with bolt through fixings and should be used in conjunction with BTL's on P389. and Eurospec locks. For matching escutcheons SZM001-3 see P15. For matching bathroom turn SZM004 see P16.

SEROZZETTA



SZM160





TREND
Lever on Round Rose
Concealed Fix 2 Part Screw-on-Rose

Dimensions (mm):

Rose:	51 Dia.
Rose Thickness:	10
Projection:	65
Lever Length:	130
Bar:	20 Dia.

BN
 CPSN



SZM200

URBAN
Lever on Round Rose
Concealed Fix 2 Part Screw-on-Rose

Dimensions (mm):

Rose:	51 Dia.
Rose Thickness:	10
Projection:	67
Lever Length:	125

CP
 SC





SZM210

EDGE
Lever on Round Rose
Concealed Fix 2 Part Screw-on-Rose





Dimensions (mm):

Rose:	51 Dia.
Rose Thickness:	10
Projection:	62
Lever Length:	119

CP
 SC

SEROZZETTA



SZM210SQ





CONCEPT
Lever on Square Rose
Concealed Fix 2 Part Screw-on-Rose

Dimensions (mm):

Rose:	51x51
Rose Thickness:	10
Projection:	62
Lever Length:	119

CP



SZM220





CONCEPT
Lever on Round Rose
Concealed Fix 2 Part Screw-on-Rose

Dimensions (mm):

Rose:	51 Dia.
Rose Thickness:	10
Projection:	56
Lever Length:	125

CP
 SC



SZM230

CITY
Lever on Round Rose
Concealed Fix 2 Part Screw-on-Rose

Dimensions (mm):

Rose:	51 Dia.
Rose Thickness:	10
Projection:	69
Lever Length:	130

CP
 SC

Serozzetta levers are supplied with bolt through fixings and should be used in conjunction with BTL's on P389, and Eurospec locks. For matching escutcheons SZM001-3 see P15. For matching bathroom turn SZM004 see P16. For matching square escutcheons SZM001-3SQ see P16. For matching square bathroom turn SZM004SQ see P17.

SEROZZETTA













SZM250

IMAGE
Lever on Round Rose
Concealed Fix 2 Part Screw-on-Rose

Dimensions (mm):
 Rose: 51 Dia.
 Rose Thickness: 10
 Projection: 65
 Lever Length: 133
 Bar: 20 Dia.

 **CPSC**















SZM320

CUBE
Concealed Fix Lever on Square Rose
Grub Screw Fixing on Rose

Dimensions (mm):
 Rose: 51.5x51.5
 Rose Thickness: 10
 Projection: 67
 Lever Length: 130

 **BN**  **CP**  **SC**







SZM370

EQUI
Concealed Fix Lever on Square Rose
Grub Screw Fixing on Rose

Dimensions (mm):
 Rose: 51.5x51.5
 Rose Thickness: 10
 Projection: 66
 Lever Length: 125

 **BN**  **CP**  **SC**

SEROZZETTA





SZM380

DESIGN
Lever on Round Rose
Concealed Fix 2 Part Screw-on-Rose

Dimensions (mm):

Rose:	51 Dia.
Rose Thickness:	10
Projection:	72
Lever Length:	119

CP

SC





SZ500

DDA COMPLIANT LEVER
Lever on Round Rose
Concealed Fix 2 Part Screw-on-Rose

Dimensions (mm):

Rose:	51 Dia.
Rose Thickness:	10
Projection:	68
Lever Length:	154
Bar:	19 Dia.

CP

PVD

SC



SZM001/2/3

ESCUTCHEON
Concealed Fix 2 Part Screw-on-Rose

Dimensions (mm):

Rose:	51 Dia.
Rose Thickness:	10

SZM001 Euro

SZM002 Oval

SZM003 Lock

BN

PVD





CP

SC

Serozzetta levers are supplied with bolt through fixings and should be used in conjunction with BTL's on P389. and Eurospec locks. SZM002 not available in BN finish.

SEROZZETTA

















SZM004

THUMBTURN AND RELEASE
 Concealed Fix
 2 Part Screw-on-Rose

Dimensions (mm):
 Rose: 51 Dia.
 Rose Thickness: 10

 BN
 CP
 SC

















SZ5004

DDA COMPLIANT THUMBTURN AND RELEASE
 Concealed Fix
 2 Part Screw-on-Rose

Dimensions (mm):
 Rose: 51 Dia.
 Rose Thickness: 10

 CP
 PVD
 SC











SZM001/2/3SQ

SQUARE ESCUTCHEON
 Concealed Fix
 2 Part Screw-on-Rose

Dimensions (mm):
 Rose: 51x51
 Rose Thickness: 10

SZM001SQ Euro
SZM002SQ Oval
SZM003SQ Lock

 BN
 CP
 SC



SZM004SQ



**SQUARE THUMBTURN AND
RELEASE**

Concealed Fix
2 Part Screw-on-Rose

Dimensions (mm):

Rose: 51x51
Rose Thickness: 10







Designer Levers on Screw on Rose



SEROZZETTA



ZIN3003





NOXIA
Lever on Round Rose
Concealed Fix 2 Part Screw-on-Rose

Dimensions (mm):

Rose:	51 Dia.
Rose Thickness:	10
Projection:	59
Lever Length:	123
Bar:	18 Dia.

PC
 SC



ZIN3004





TROY
Lever on Round Rose
Concealed Fix 2 Part Screw-on-Rose

Dimensions (mm):

Rose:	51 Dia.
Rose Thickness:	10
Projection:	59
Lever Length:	123
Bar:	18 Dia.

PCSC



ZIN3111

NELSON
Lever on Round Rose
Concealed Fix 2 Part Screw-on-Rose

Dimensions (mm):





Rose:	51 Dia.
Rose Thickness:	10
Projection:	57
Lever Length:	128

PC
 SC

Serozzetta levers are supplied with bolt through fixings and should be used in conjunction with BTL's on P389. and Eurospec locks. For matching escutcheons ZEE/ZEP/ZEU3005 see P25. For matching bathroom turn ZET3005 see P25.

SEROZZETTA



ZIN3112





OLIVIER
Lever on Round Rose
Concealed Fix 2 Part Screw-on-Rose

Dimensions (mm):

Rose:	51 Dia.
Rose Thickness:	10
Projection:	60
Lever Length:	125

PC
 SC



ZIN3113





TEMPEST
Lever on Round Rose
Concealed Fix 2 Part Screw-on-Rose

Dimensions (mm):

Rose:	51 Dia.
Rose Thickness:	10
Projection:	59
Lever Length:	116

PC
 SC



ZIN3114

TITAN
Lever on Round Rose
Concealed Fix 2 Part Screw-on-Rose





Dimensions (mm):

Rose:	51 Dia.
Rose Thickness:	10
Projection:	57
Lever Length:	121

PC
 SC

SEROZZETTA



ZIN3115

CAROLINA
Lever on Round Rose
Concealed Fix 2 Part Screw-on-Rose



Dimensions (mm):

Rose:	51 Dia.
Rose Thickness:	10
Projection:	59
Lever Length:	126
Bar:	17 Dia.

PC SC





ZIN3116





ATALAYA
Lever on Round Rose
Concealed Fix 2 Part Screw-on-Rose

Dimensions (mm):

Rose:	51 Dia.
Rose Thickness:	10
Projection:	57
Lever Length:	128
Bar:	16 Dia.

PC SC



ZIN3117

CLASSIC
Lever on Round Rose
Concealed Fix 2 Part Screw-on-Rose

Dimensions (mm):

Rose:	51 Dia.
Rose Thickness:	10
Projection:	67
Lever Length:	114

PC SC

Serozzetta levers are supplied with bolt through fixings and should be used in conjunction with BTL's on P389. and Eurospec locks. For matching escutcheons ZEE/ZEP/ZEU3005 see P25. For matching bathroom turn ZET3005 see P25.

SEROZZETTA



--	--	--	--

ZIN3118

SHORE
Lever on Round Rose
Concealed Fix 2 Part Screw-on-Rose

Dimensions (mm):

Rose:	51 Dia.
Rose Thickness:	10
Projection:	67
Lever Length:	120
Bar:	19 Dia.

PCSC



--	--	--	--

ZIN3121

PHILADELPHIA
Lever on Round Rose
Concealed Fix 2 Part Screw-on-Rose

Dimensions (mm):

Rose:	51 Dia.
Rose Thickness:	10
Projection:	60
Lever Length:	124
Bar:	16 Dia.

PC **SC**



--	--	--	--

ZIN3127

VENICE
Lever on Round Rose
Concealed Fix 2 Part Screw-on-Rose





Dimensions (mm):

Rose:	51 Dia.
Rose Thickness:	10
Projection:	72
Bar:	123 Dia.

PCSC

SEROZZETTA



ZIN3129





CUMULUS
Lever on Round Rose
Concealed Fix 2 Part Screw-on-Rose

Dimensions (mm):

Rose:	51 Dia.
Rose Thickness:	10
Projection:	60
Lever Length:	129

PCSC
 SC



ZIN3130





VERDUN
Lever on Round Rose
Concealed Fix 2 Part Screw-on-Rose

Dimensions (mm):

Rose:	51 Dia.
Rose Thickness:	10
Projection:	65
Lever Length:	122

PC
 SC



ZIN3131

SHARK
Lever on Round Rose
Concealed Fix 2 Part Screw-on-Rose

Dimensions (mm):



Rose:	51 Dia.
Rose Thickness:	10
Projection:	66
Lever Length:	121

PC
 SC

Serozzetta levers are supplied with bolt through fixings and should be used in conjunction with BTL's on P389. and Eurospec locks. For matching escutcheons ZEE/ZEP/ZEU3005 see P25. For matching bathroom turn ZET3005 see P25.

SEROZZETTA











ZIN3138





MAISON
Lever on Round Rose
Concealed Fix 2 Part Screw-on-Rose

Dimensions (mm):

Rose:	51 Dia.
Rose Thickness:	10
Projection:	59
Lever Length:	130
Bar:	20 Dia.

 **PCSC**
 **PNSN**









ZIN3139





IRWIN
Lever on Round Rose
Concealed Fix 2 Part Screw-on-Rose

Dimensions (mm):

Rose:	51 Dia.
Rose Thickness:	10
Projection:	63
Lever Length:	123
Bar:	19 Dia.

 **PCSC**









ZIN3140

MARISSA
Lever on Round Rose
Concealed Fix 2 Part Screw-on-Rose

Dimensions (mm):

Rose:	51 Dia.
Rose Thickness:	10
Projection:	69
Lever Length:	129

 **PC**
 **SC**

SEROZZETTA







ZIN3144

MANON
Lever on Round Rose
Concealed Fix 2 Part Screw-on-Rose

Dimensions (mm):
Rose: 51 Dia.
Rose Thickness: 10
Projection: 73
Lever Length: 142

PC SC





ZEE/ZEP/ZEU3005

ESCUTCHEON
Concealed Fix
2 Part Screw-on-Rose

Dimensions (mm):
Rose: 51 Dia.
Rose Thickness: 10

ZEE3005 Euro
ZEP3005 Lock
ZEU3005 Oval

PC SC





ZET3005

THUMBTURN AND RELEASE
Concealed Fix
2 Part Screw-on-Rose

Dimensions (mm):
Rose: 51 Dia.
Rose Thickness: 10

PC SC

Serozzetta levers are supplied with bolt through fixings and should be used in conjunction with BTL's on P389. and Eurospec locks.

SEROZZETTA





PH110

AZUL PULL HANDLE

Dimensions (mm):

Bar: 20 Dia.

PH110A 225c/c

PH110B 305c/c

 **CP**  **CPSC**





PH160

TREND PULL HANDLE

Dimensions (mm):

Bar: 20 Dia.

PH160A 225c/c

PH160B 305c/c

 **CP**  **CPSN**  **SC**





PH500

DDA COMPLIANT PULL HANDLE



Dimensions (mm):

Bar: 22 Dia.

PH500B 225c/c

PH500C 305c/c

PH500E 450c/c

 **CP**  **PVD**  **SC**

SEROZZETTA



--	--	--	--

PH3115

PULL HANDLE

Dimensions (mm):
 Rose: 51 Dia.
 Bar: 17 Dia.
 Centres: 225

PC



--	--	--	--

PH3121

PULL HANDLE

Dimensions (mm):
 Rose: 51 Dia.
 Bar: 17 Dia.
 Centres: 225

PC **SC**



--	--	--	--

PH52

ROSE KIT

Dimensions (mm):
 Rose: 51 Dia.
 Rose Thickness: 10

CP **CPSN**
 CPSC **PVD**

For matching escutcheons SZM001-3 see P15. For matching bathroom turn SZM004 see P16.
 PH3115 for matching lever ZIN3115 see P21. PH3121 for matching lever ZIN3121 see P22.

Designer Levers on Backplate



SEROZZETTA



--	--	--	--

SZC011Y

UNO
Lever on Euro Backplate
47.5c/c

Dimensions (mm):
 Backplate: 170x42
 Projection: 76
 Lever Length: 122
 Plate Thickness: 10

Variations:

SZC011	Lock
SZC012	Latch
SZC013	Bathroom

CP
 SC



--	--	--	--

SZC023

DOS
Lever on Bathroom Backplate

Dimensions (mm):
 Backplate: 170x42
 Projection: 67
 Lever Length: 110
 Plate Thickness: 10

Variations:

SZC021	Lock
SZC021Y	Euro 47.5c/c
SZC022	Latch

CP
 SC

SEROZZETTA

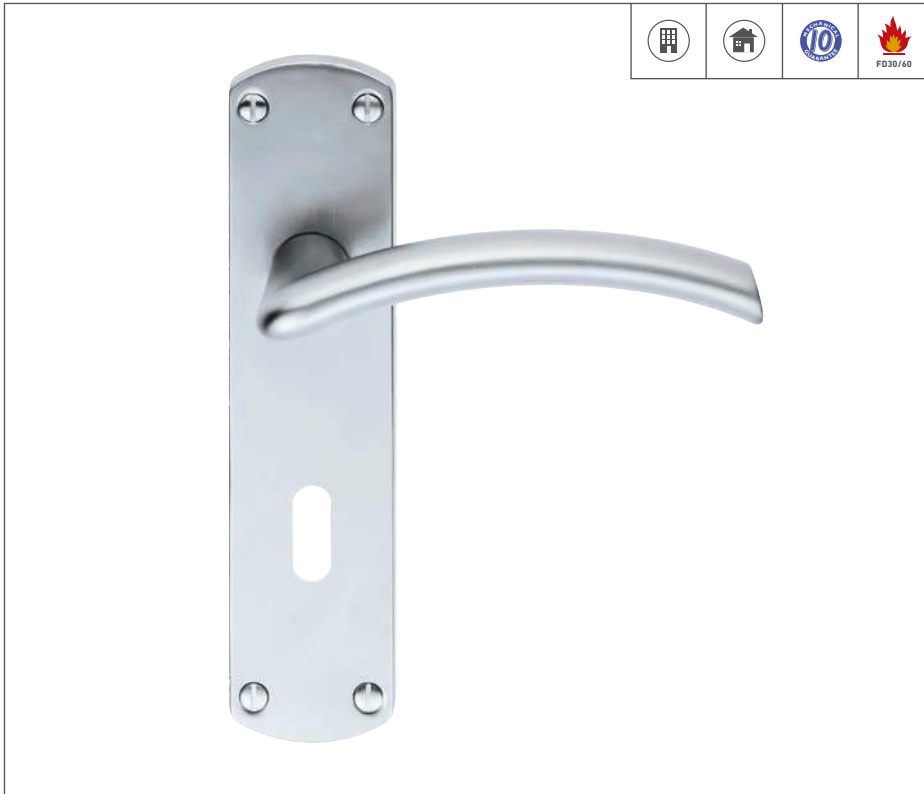

SZC031

TRES
Lever on Lock Backplate

Dimensions (mm):
 Backplate: 170x42
 Projection: 70
 Lever Length: 113
 Plate Thickness: 10

Variations:
SZC031Y Euro 47.5c/c
SZC032 Latch
SZC033 Bathroom

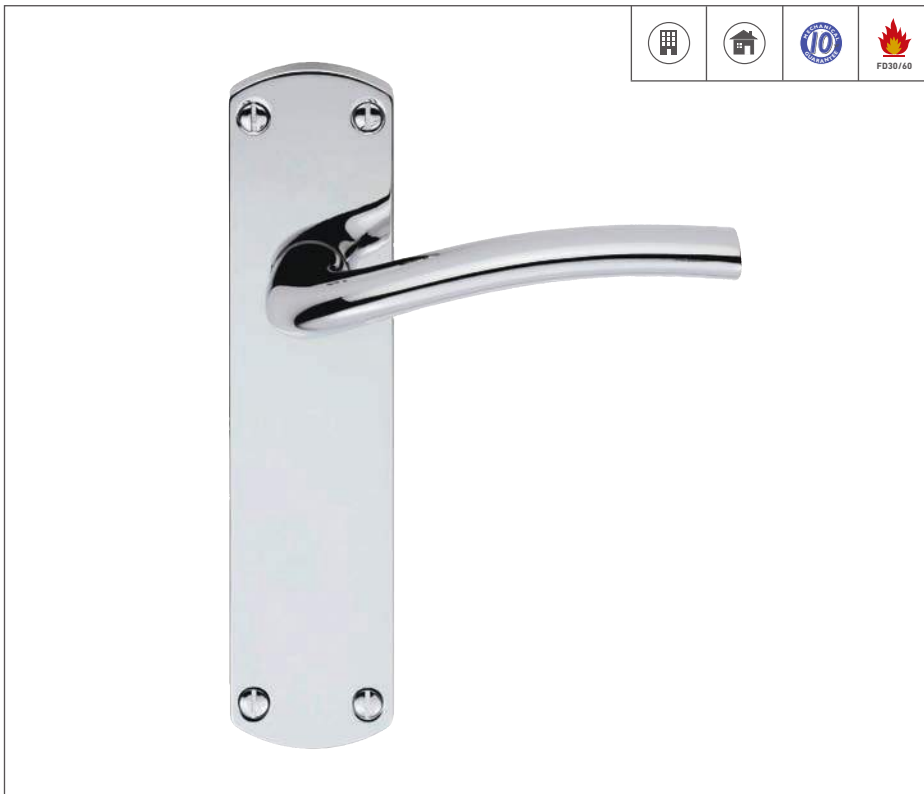

SZC042

CUATRO
Lever on Latch Backplate

Dimensions (mm):
 Backplate: 170x42
 Projection: 71
 Lever Length: 110
 Plate Thickness: 10

Variations:
SZC041 Lock
SZC041Y Euro 47.5c/c
SZC043 Bathroom



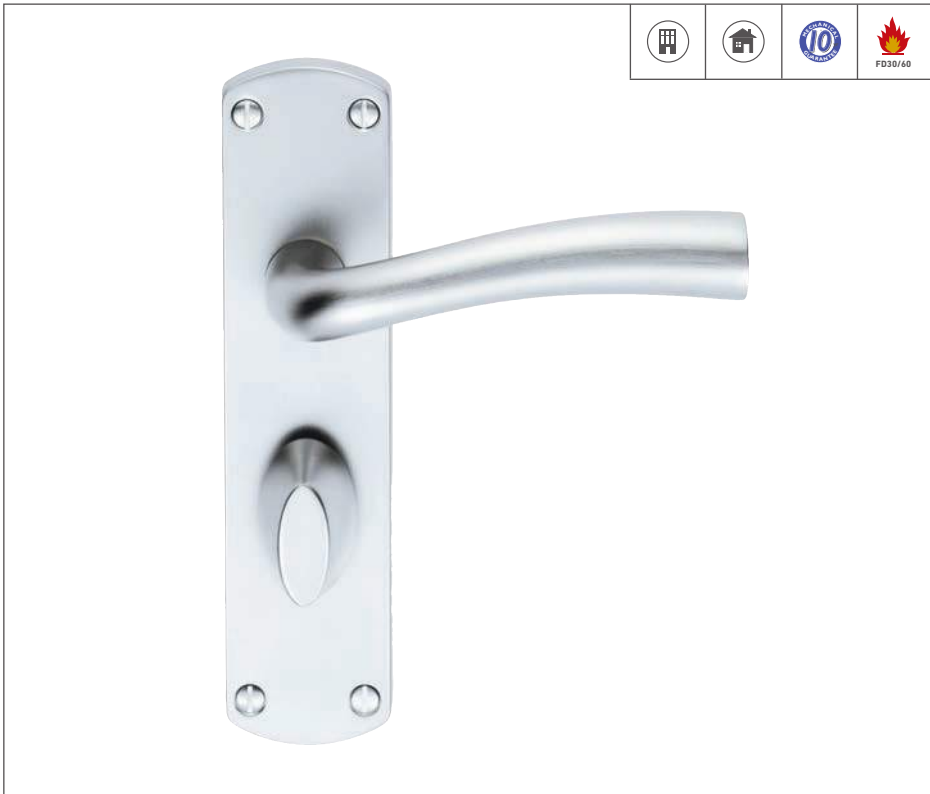

SZC053

CINCO

Lever on Bathroom Backplate

Dimensions (mm):

Backplate:	170x42
Projection:	67
Lever Length:	110
Plate Thickness:	10

Variations:

SZC051	Lock
SZC051Y	Euro 47.5c/c
SZC052	Latch

CP SC

Designer Levers on Backplate



SEROZZETTA



SZM035

ZONE
Lever on Latch Backplate

Dimensions (mm):
 Backplate: 180x40
 Projection: 65
 Lever Length: 120
 Plate Thickness: 10

Variations:
SZM034 Lock
SZM034Y Euro 47.5c/c
SZM036 Bathroom

CP SC



SZM045

SCOPE
Lever on Latch Backplate

Dimensions (mm):
 Backplate: 180x40
 Projection: 65
 Lever Length: 130
 Bar: 20 Dia.
 Plate Thickness: 10

Variations:
SZM044 Lock
SZM046 Bathroom
SZM044Y Euro 47.5c/c

CP CPSN

SZM044Y not available in CPSN finish.

SEROZZETTA

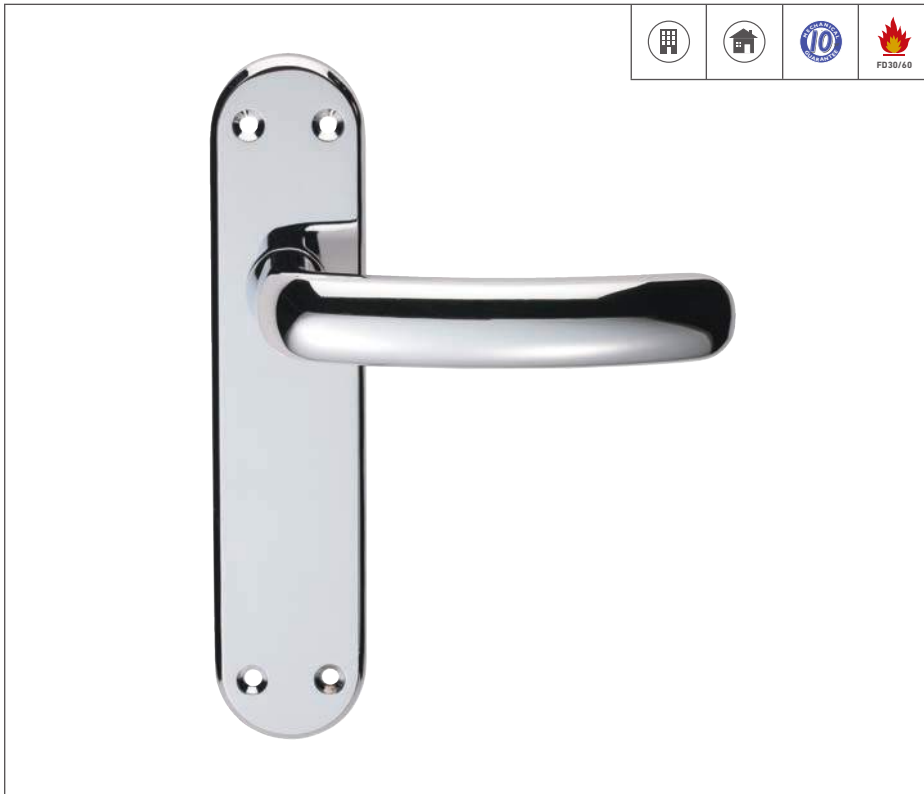

SZM056

SHAPE

Lever on Latch Backplate

Dimensions (mm):

Backplate: 180x40
 Projection: 61
 Lever Length: 117
 Plate Thickness: 10

Variations:

SZM055 Lock
SZM055Y Euro 47.5c/c
SZM057 Bathroom

CP

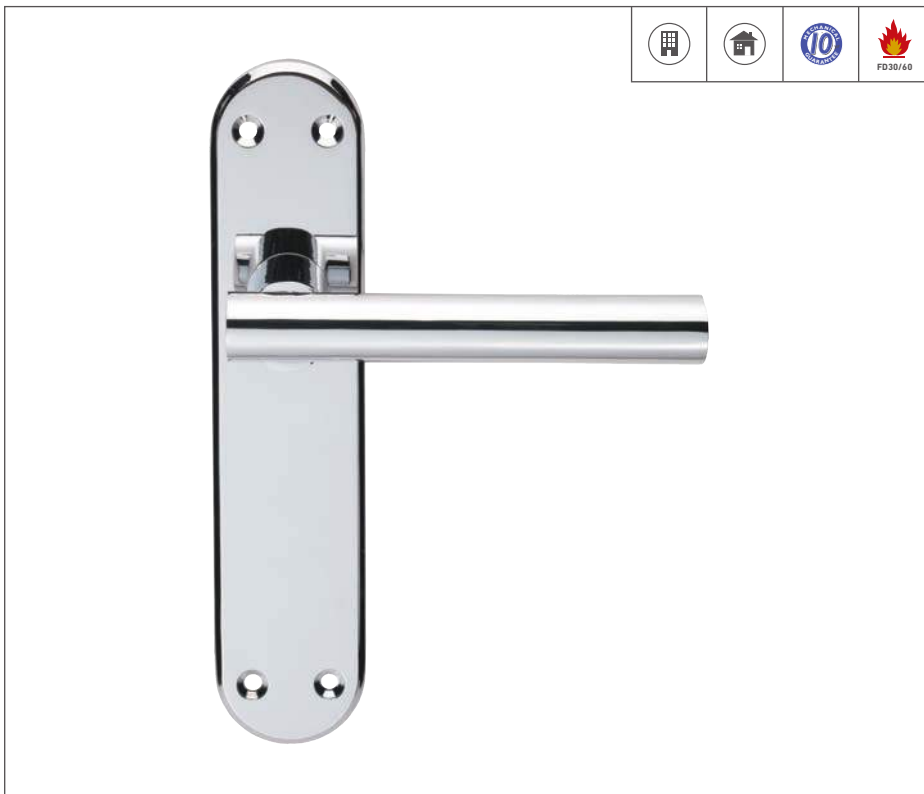

SZM067

SYSTEM

Lever on Latch Backplate

Dimensions (mm):

Backplate: 180x40
 Projection: 63
 Lever Length: 114
 Bar: 17 Dia.
 Plate Thickness: 10

Variations:

SZM066 Lock
SZM066Y Euro 47.5 c/c
SZM068 Bathroom

CP

SEROZZETTA



--	--	--	--

SZM243

STRATUS
Lever on Bathroom Backplate

Dimensions (mm):
 Backplate: 180x40
 Projection: 69
 Lever Length: 129
 Plate Thickness: 10

Variations:

SZM242	Latch
SZM241	Lock
SZM241Y	Euro 47.5c/c

CP



--	--	--	--

SZM371

EQUI
Lever on Lock Backplate

Dimensions (mm):
 Backplate: 180x40
 Projection: 65
 Lever Length: 125
 Plate Thickness: 10

Variations:





SZM372	Latch
SZM371Y	Euro 47.5c/c
SZM373	Bathroom

CP SC

Premium Quality Designer Levers on Screw on Rose





SZS060





MORADO
Lever on Round Rose
Concealed Fix 2 Part Screw-on-Rose

Dimensions (mm):

Rose:	50 Dia.
Rose Thickness:	10
Projection:	66
Lever Length:	128

CP
 SC



SZS070





GRIS
Lever on Round Rose
Concealed Fix 2 Part Screw-on-Rose

Dimensions (mm):

Rose:	50 Dia.
Rose Thickness:	10
Projection:	66
Lever Length:	115

CP
 SC



SZS080





MORENO
Lever on Round Rose
Concealed Fix 2 Part Screw-on-Rose

Dimensions (mm):

Rose:	50 Dia.
Rose Thickness:	10
Projection:	65
Lever Length:	116

CP
 SC



SZS130





BLANCO
Lever on Round Rose
Concealed Fix 2 Part Screw-on-Rose

Dimensions (mm):

Rose:	50 Dia.
Rose Thickness:	10
Projection:	63
Lever Length:	115

CP
 SC



SZS350





TOPO
Lever on Round Rose
Concealed Fix 2 Part Screw-on-Rose

Dimensions (mm):

Rose:	50 Dia.
Rose Thickness:	10
Projection:	67
Lever Length:	124

CPSC



AA1/2/3

ESCUTCHEON
Concealed Fix 2 Part Screw-on-Rose

Dimensions (mm):

Rose:	50 Dia.
Rose Thickness:	10

AA1 Euro
AA2 Oval
AA3 Lock

BN
 PB

CP
 SC



Serozzetta levers are supplied with bolt through fixings and should be used in conjunction with BTL's on P389 and Eurospec locks. AA2 not available in BN finish. AA0 blank escutcheon also available. For matching bathroom turns AA12 and AQ11-12 see P39.





AA12

THUMBTURN AND RELEASE
 Concealed Fix
 2 Part Screw-on-Rose

Dimensions (mm):
 Rose: 50 Dia.
 Rose Thickness: 10

Variations:
 AA12L Long Spindle

CP
 PB
 SC







AQ12

THUMBTURN AND RELEASE
 Concealed Fix
 2 Part Screw-on-Rose

Dimensions (mm):
 Rose: 50 Dia.
 Rose Thickness: 10

CP
 PB
 SC





AQ11

THUMBTURN AND RELEASE WITH INDICATOR
 Concealed Fix
 2 Part Screw-on-Rose

Dimensions (mm):
 Rose: 50 Dia.
 Rose Thickness: 10

CP
 PB
 SC

European Designer Collection



EUROPEAN DESIGN



CEB010Q

MONO

Lever on Square Rose
Concealed Fix 2 Part Screw-on-Rose

Dimensions (mm):

Rose:	52x52
Rose Thickness:	10
Projection:	57
Lever Length:	149



CEB020Q

SEA

Lever on Square Rose
Concealed Fix 2 Part Screw-on-Rose

Dimensions (mm):

Rose:	52x52
Rose Thickness:	10
Projection:	56
Lever Length:	132



CEB030Q

S CHI

Lever on Square Rose
Concealed Fix 2 Part Screw-on-Rose

Dimensions (mm):

Rose:	52x52
Rose Thickness:	10
Projection:	60
Lever Length:	135



EUROPEAN DESIGN

CEB001/3Q

ESCUTCHEON
Concealed Fix 2 Part Screw-on-Rose

Dimensions (mm):
 Rose: 52x52
 Rose Thickness: 10

CEB001Q Euro
CEB003Q Lock

CP
 SC

CEB004Q

THUMBTURN AND RELEASE
Concealed Fix 2 Part Screw-on-Rose

Dimensions (mm):
 Rose: 52x52
 Rose Thickness: 10

CP
 SC

100% ITALIAN MANUFACTURE







DND010

GRIP
Lever on Round Rose
Concealed Fix 2 Part Screw-on-Rose



Dimensions (mm):

Rose:	50
Rose Thickness:	8
Projection:	67
Lever Length:	125

CP

SC



DND020

LINK
Lever on Round Rose
Concealed Fix 2 Part Screw-on-Rose





Dimensions (mm):

Rose:	50
Rose Thickness:	8
Projection:	58
Lever Length:	128

CP

SC



DND030

QUATTRO 02
Lever on Square Rose
Concealed Fix 2 Part Screw-on-Rose

Dimensions (mm):





Rose:	50x50
Rose Thickness:	8
Projection:	52
Lever Length:	129

CPSC



100% ITALIAN MANUFACTURE



 

 FD30/60

DND001/3 + DND001/3Q

ESCUTCHEON
Concealed Fix 2 Part Screw-on-Rose

Round Dimensions (mm):
Rose: 50 Dia.





DND001 Euro
DND003 Lock

Square Dimensions (mm):
Square: 50x50

DND001Q Euro
DND003Q Lock

CP SC



 

 FD30/60





DND004

THUMBTURN AND RELEASE
Concealed Fix 2 Part Screw-on-Rose

Dimensions (mm):
Rose: 50 Dia.

CP SC



 

 FD30/60

DND004Q

THUMBTURN AND RELEASE
Concealed Fix 2 Part Screw-on-Rose

Dimensions (mm):
Rose: 50x50





CP



DND001Q and DND003Q not available in SC finish.

100% ITALIAN MANUFACTURE



AQ1

STELLA
Lever on Round Rose
Concealed Fix 2 Part Screw-on-Rose

Dimensions (mm):
 Rose: 50 Dia.
 Rose Thickness: 10
 Projection: 74
 Lever Length: 110

CP
 SC
 PB
 SN













AQ2

STUDIO H
Lever on Round Rose
Concealed Fix 2 Part Screw-on-Rose

Dimensions (mm):
 Rose: 50 Dia.
 Rose Thickness: 10
 Projection: 65
 Lever Length: 120
 Bar: 17 Dia.

CP
 PB
 SC



AQ3

APOLLO
Lever on Round Rose
Concealed Fix 2 Part Screw-on-Rose

Dimensions (mm):
 Rose: 50 Dia.
 Rose Thickness: 10
 Projection: 65
 Lever Length: 118

CP
 SC
 PB
 SN

For matching escutcheons AA1-3 see P51. For matching bathroom turns AA12 and AQ11-12 see P51-52.
 AQ1 for matching pull handle AA15 see P138. AQ2 for matching pull handle AA16A-E see P53.



100% ITALIAN MANUFACTURE





AQ4

CALLA
Lever on Round Rose
Concealed Fix 2 Part Screw-on-Rose

Dimensions (mm):

Rose:	50 Dia.
Rose Thickness:	10
Projection:	63
Lever Length:	114
Bar:	17 Dia.

CP

SC

PB

SN





AQ5

VERONICA
Lever on Round Rose
Concealed Fix 2 Part Screw-on-Rose

Dimensions (mm):

Rose:	50 Dia.
Rose Thickness:	10
Projection:	61
Lever Length:	120

CP

PB





AQ8

SQUIGGLE
Lever on Round Rose
Concealed Fix 2 Part Screw-on-Rose

Dimensions (mm):

Rose:	50 Dia.
Rose Thickness:	10
Projection:	63
Lever Length:	128
Bar:	18 Dia.

CP





PB

SC



For matching escutcheons AA1-3 see P51. For matching bathroom turns AA12 and AQ11-12 see P51-52. AQ4 for matching pull handle AA14A-B see P52. AQ5 for matching pull handle AA19 see P53.

100% ITALIAN MANUFACTURE

DA5







DALI
Lever on Round Rose
Concealed Fix 2 Part Screw-on-Rose

Dimensions (mm):

Rose:	50 Dia.
Rose Thickness:	10
Projection:	65
Lever Length:	123

CP

SC

DR5F







DERBY
Lever on Round Rose
Concealed Fix 2 Part Screw-on-Rose

Dimensions (mm):

Rose:	50 Dia.
Rose Thickness:	10
Projection:	63
Lever Length:	135

CP

SC

EL5



ELIS
Lever on Round Rose
Concealed Fix 2 Part Screw-on-Rose

Dimensions (mm):

Rose:	50 Dia.
Rose Thickness:	10
Projection:	62
Lever Length:	144

SC

100% ITALIAN MANUFACTURE













FH5

FLASH
Lever on Square Rose
Concealed Fix Press-on-Rose

Dimensions (mm):
Rose: 51x51
Rose Thickness: 10
Projection: 54
Lever Length: 128

BLK
 SC
 CP
 WHT













FR5F

FRANCY
Lever on Round Rose
Concealed Fix 2 Part Screw-on-Rose

Dimensions (mm):
Rose: 51 Dia.
Rose Thickness: 10
Projection: 70
Lever Length: 121

CP
 SC



GI5

GIAVA
Lever on Round Rose
Concealed Fix 2 Part Screw-on-Rose

Dimensions (mm):
Rose: 50 Dia.
Rose Thickness: 10
Projection: 66
Lever Length: 131



CP
 PB
 SC



FR5F and GI5 for matching escutcheons AA1-3 see P51. FR5F and GI5 for matching bathroom turns AA12 and AQ11-12 see P51-52. FH5 matching square escutcheons QE001-3 available. FH5 matching square bathroom turn QT004 available. Contact our sales office on 01228 511030 for details.

100% ITALIAN MANUFACTURE





LM5





LE MANS
Lever on Round Rose
Concealed Fix 2 Part Screw-on-Rose

Dimensions (mm):

Rose:	50 Dia.
Rose Thickness:	10
Projection:	55
Lever Length:	138

CP



NI5





NIRVANA
Lever on Round Rose
Concealed Fix 2 Part Screw-on-Rose

Dimensions (mm):

Rose:	50 Dia.
Rose Thickness:	10
Projection:	63
Lever Length:	129

CP SC



PE5

PETRA
Lever on Round Rose
Concealed Fix 2 Part Screw-on-Rose

Dimensions (mm):

Rose:	50 Dia.
Rose Thickness:	10
Projection:	55
Lever Length:	123

CP

100% ITALIAN MANUFACTURE









TC5

TECHNA
Lever on Square Rose
Concealed Fix Press-on-Rose

Dimensions (mm):
Rose: 51x51
Rose Thickness: 10
Projection: 54
Lever Length: 129

BLK
 SC
 CP
 WHT













UO5

UOVO
Lever on Round Rose
Concealed Fix 2 Part Screw-on-Rose

Dimensions (mm):
Rose: 50 Dia.
Rose Thickness: 10
Projection: 79
Lever Length: 78

CP



WD5

WIND
Lever on Round Rose
Concealed Fix 2 Part Screw-on-Rose

Dimensions (mm):
Rose: 50 Dia.
Rose Thickness: 10
Projection: 66
Lever Length: 128

CP
 PB
 SC



UO5 and WD5 for matching escutcheons AA1-3 see P51. UO5 and WD5 for matching bathroom turns AA12 and AQ11-12 see P51-52. TC5 matching square escutcheons QE001-3 available. TC5 matching square bathroom turn QT004 available. Contact our sales office on 01228 511030 for details.

100% ITALIAN MANUFACTURE





AA1/2/3

ESCUTCHEON
Concealed Fix 2 Part Screw-on-Rose

Dimensions (mm):
 Rose: 50 Dia.
 Rose Thickness: 10

AA1 Euro
AA2 Oval
AA3 Lock





BN

PB

CP

SC



AA12

THUMBTURN AND RELEASE
Concealed Fix
2 Part Screw-on-Rose

Dimensions (mm):
 Rose: 50 Dia.
 Rose Thickness: 10





Variations:
AA12L Long Spindle

CP

PB

SC



AQ12

THUMBTURN AND RELEASE
Concealed Fix
2 Part Screw-on-Rose

Dimensions (mm):
 Rose: 50 Dia.
 Rose Thickness: 10

CP

PB

SC



100% ITALIAN MANUFACTURE







AQ11

THUMBTURN AND RELEASE WITH INDICATOR
Concealed Fix
2 Part Screw-on-Rose

Dimensions (mm):
Rose: 50 Dia.
Rose Thickness: 10

CP
 PB
 SC





AA14A-B

CALLA
Concealed Fix
Pull Handle on Rose

Dimensions (mm):
Rose: 50 Dia.
Bar: 17 Dia.

AA14A 200c/c
AA14B 300c/c



CP
 PB
 SC



AA14B not available in CP or SC finish. For matching lever AQ4 see P46.

100% ITALIAN MANUFACTURE



AA16A-C

STUDIO H
Concealed Fix
Pull Handle on Rose

Dimensions (mm):
Rose: 50 Dia.
Bar: 20 Dia.





AA16A 150c/c
AA16B 229c/c
AA16C 305c/c

CP

PB

SC



AA19

VERONICA
Concealed Fix
Pull Handle on Rose

Dimensions (mm):
Rose: 50 Dia.

AA19 170c/c

CP

AA16A, C, D and E not available in SC finish. For matching lever AQ2 see P45.
AA19 For matching lever AQ5 see P46.



100% ITALIAN MANUFACTURE



ART55B

SLIDING DOOR SET
Sliding Door Set with WC Turn,
Flush Pull and Lock

Dimensions (mm):
Turn: 57 Dia.
Flush Pull: 29 Dia.

Variations:
ART55BQ Square Rose

CP

SC

SN



ART56

SMALL FLUSH PULL

Dimensions (mm):
Flush Pull: 29 Dia.

CP

SC

SN



100% ITALIAN MANUFACTURE



ART85B

OTTO SLIDING DOOR SET

Sliding Door Set with WC Turn, Flush Pull and Lock

Dimensions (mm):

Flush Pull: 88x55



ART84

OTTO SLIDING DOOR FLUSH PULL

Dimensions (mm):

Flush Pull: 88x55



100% ITALIAN MANUFACTURE

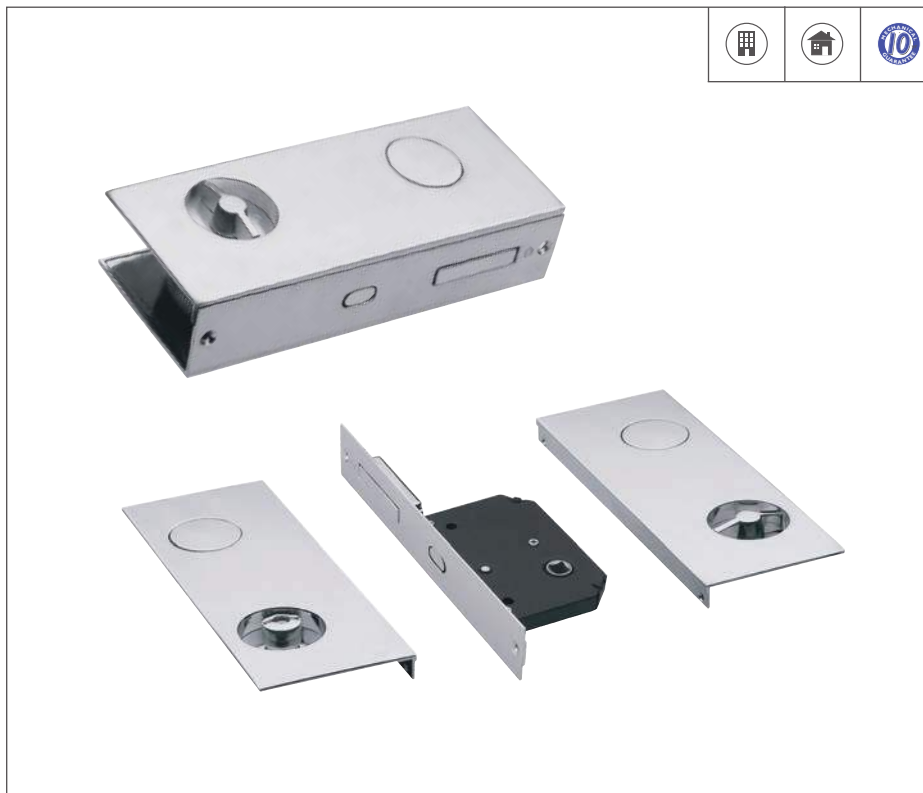

ARTFT

FLAT SLIDING DOOR SET
Sliding Door Set with WC Turn
and Lock

Dimensions (mm):
Plate: 38-45x210



ARTFTS

**FLAT SMALL SLIDING
DOOR SET**



Dimensions (mm):
Plate: 38-45x100







Grade 304 Stainless Steel Levers on Press on Rose



STEELWORX® 304 STAINLESS STEEL

		<p>CSL1121</p> <p>LEVER ON SPRUNG ROSE Concealed Fix Press-on-Rose</p> <p>Dimensions (mm): Rose: 52 Dia. Rose Thickness: 8 Projection: 65 Lever Length: 127</p> <p> SSS</p>
-----------------------------------------------------------------------------------	-----------------------------------------------------------------------------------	--------------------------------------------------------------------------------------------------------------------------------------------------------------------------------------------------------------------------------------------------------------------------------------------------------------------------------------------------------------------------

		<p>CSL1127</p> <p>LEVER ON SPRUNG ROSE Concealed Fix Press-on-Rose</p> <p>Dimensions (mm): Rose: 52 Dia. Rose Thickness: 8 Projection: 63 Lever Length: 124</p> <p> SSS</p>
------------------------------------------------------------------------------------	-----------------------------------------------------------------------------------	----------------------------------------------------------------------------------------------------------------------------------------------------------------------------------------------------------------------------------------------------------------------------------------------------------------------------------------------------------------------------

		<p>CSL1134</p> <p>LEVER ON SPRUNG ROSE Concealed Fix Press-on-Rose</p> <p>Dimensions (mm): Rose: 52 Dia. Rose Thickness: 8 Projection: 61 Lever Length: 128</p> <p> SSS</p>
-------------------------------------------------------------------------------------	-------------------------------------------------------------------------------------	----------------------------------------------------------------------------------------------------------------------------------------------------------------------------------------------------------------------------------------------------------------------------------------------------------------------------------------------------------------------------

STEELWORX® 304 STAINLESS STEEL









CSL1160







LEVER ON SPRUNG ROSE
 Concealed Fix
 Press-on-Rose

Dimensions (mm):

Rose:	52 Dia.
Rose Thickness:	8
Projection:	72
Lever Length:	133

SSS



CSL1190

SAFETY LEVER ON SPRUNG ROSE
 Concealed Fix
 Press-on-Rose





Dimensions (mm):

Rose:	52 Dia.
Rose Thickness:	8
Projection:	66
Lever Length:	140
Bar:	19 Dia.

Variations:
CSL1220 Bar 22 Dia.

BSSSSS



CSL1191

STRAIGHT LEVER ON SPRUNG ROSE
 Concealed Fix
 Press-on-Rose

Dimensions (mm):

Rose:	52 Dia.
Rose Thickness:	8
Projection:	66
Lever Length:	133
Bar:	19 Dia.

SSS

Steelworx levers are supplied with bolt through fixings and should be used in conjunction with BTL's on P389. and Eurospec locks. For matching escutcheons CSE/CSP/CSU1005 see P61. For matching bathroom turns CST1015 and CST1025 see P61-62.

STEELWORX® 304 STAINLESS STEEL





CSL1192

MITRED LEVER ON SPRUNG ROSE
 Concealed Fix
 Press-on-Rose

Dimensions (mm):

Rose:	52 Dia.
Rose Thickness:	8
Projection:	66
Lever Length:	128
Round Bar:	19 Dia.

BSS
 SSS





CSL1193

CURVED LEVER ON SPRUNG ROSE
 Concealed Fix
 Press-on-Rose

Dimensions (mm):

Rose:	52 Dia.
Rose Thickness:	8
Projection:	66
Lever Length:	137
Bar:	19 Dia.

BSS
 SSS





CSL1194

STRAIGHT LEVER ON SPRUNG ROSE
 Concealed Fix
 Press-on-Rose





Dimensions (mm):

Rose:	52 Dia.
Rose Thickness:	8
Projection:	66
Lever Length:	137
Bar:	19 Dia.

BSS
 SSS

STEELWORX® 304 STAINLESS STEEL



				
		BS EN 1906		FD30/60

CSL1195

MITRED LEVER ON SPRUNG ROSE
 Concealed Fix
 Press-on-Rose

Dimensions (mm):

Rose:	52 Dia.
Rose Thickness:	8
Projection:	66
Lever Length:	128
Oval Bar:	19 Dia.

 **SSS**



			
			FD30/60

CSE/CSP/CSU1005

ESCUTCHEON
 Concealed Fix Press-on-Rose





Dimensions (mm):

Rose:	52 Dia.
Rose Thickness:	8

CSE1005	Euro
CSP1005	Lock
CSU1005	Oval

 **BSS**  **SSS**





			
			FD30/60

CST1015

THUMBTURN AND RELEASE
 Concealed Fix
 Press-on-Rose

Dimensions (mm):

Rose:	52 Dia.
Rose Thickness:	8

 **BSS**  **SSS**

Steelworx levers are supplied with bolt through fixings and should be used in conjunction with BTL's on P389. and Eurospec locks. For matching bathroom turn CST1025 see P62. CST1015 supplied with additional non indicator rose.

STEELWORX® 304 STAINLESS STEEL



CST1025



DISABLED THUMBTURN AND RELEASE

Concealed Fix Press-on-Rose

Dimensions (mm):

Rose: 52 Dia.
Rose Thickness: 8

Variations:



CST1025K 5mm Allen Key Release



 **BSS**  **SSS**



Grade 304 Stainless Steel Levers on Square Press on Rose



STEELWORX® 304 STAINLESS STEEL



		SSL1401
<p>MITRED LEVER ON SPRUNG ROSE Concealed Fix Square Press-on-Rose</p> <p>Dimensions (mm): Rose: 52x52 Rose Thickness: 8 Projection: 66 Lever Length: 128 Bar: 19x19</p> <p> SSS</p>		



		SSL1402
<p>FLAT LEVER ON SPRUNG ROSE Concealed Fix Square Press-on-Rose</p> <p>Dimensions (mm): Rose: 52x52 Rose Thickness: 8 Projection: 66 Lever Length: 135 Bar: 10x20</p> <p> SSS</p>		

		SSL1403
<p>RECTANGULAR LEVER ON SPRUNG ROSE Concealed Fix Square Press-on-Rose</p> <p>Dimensions (mm): Rose: 52x52 Rose Thickness: 8 Projection: 66 Lever Length: 135 Bar: 24x12</p> <p> SSS</p>		

STEELWORX® 304 STAINLESS STEEL

	<h2>SSL1404</h2>								
	<p>SHAPED LEVER ON SPRUNG ROSE Concealed Fix Square Press-on-Rose</p> <p>Dimensions (mm):</p> <table border="0"> <tr> <td>Rose:</td> <td>52x52</td> </tr> <tr> <td>Rose Thickness:</td> <td>8</td> </tr> <tr> <td>Projection:</td> <td>72</td> </tr> <tr> <td>Lever Length:</td> <td>133</td> </tr> </table> <p> SSS</p>	Rose:	52x52	Rose Thickness:	8	Projection:	72	Lever Length:	133
Rose:	52x52								
Rose Thickness:	8								
Projection:	72								
Lever Length:	133								





	<h2>SSL1405</h2>										
	<p>SQUARE LEVER ON SPRUNG ROSE Concealed Fix Square Press-on-Rose</p> <p>Dimensions (mm):</p> <table border="0"> <tr> <td>Rose:</td> <td>52x52</td> </tr> <tr> <td>Rose Thickness:</td> <td>8</td> </tr> <tr> <td>Projection:</td> <td>64</td> </tr> <tr> <td>Lever Length:</td> <td>135</td> </tr> <tr> <td>Bar:</td> <td>16x16</td> </tr> </table> <p> BSS/SSS</p>	Rose:	52x52	Rose Thickness:	8	Projection:	64	Lever Length:	135	Bar:	16x16
Rose:	52x52										
Rose Thickness:	8										
Projection:	64										
Lever Length:	135										
Bar:	16x16										

	<h2>SSL1406</h2>										
	<p>SQUARE MITRED LEVER ON SPRUNG ROSE Concealed Fix Square Press-on-Rose</p> <p>Dimensions (mm):</p> <table border="0"> <tr> <td>Rose:</td> <td>52x52</td> </tr> <tr> <td>Rose Thickness:</td> <td>8</td> </tr> <tr> <td>Projection:</td> <td>70</td> </tr> <tr> <td>Lever Length:</td> <td>129</td> </tr> <tr> <td>Bar:</td> <td>22 Dia.</td> </tr> </table> <p> BSS/SSS</p>	Rose:	52x52	Rose Thickness:	8	Projection:	70	Lever Length:	129	Bar:	22 Dia.
Rose:	52x52										
Rose Thickness:	8										
Projection:	70										
Lever Length:	129										
Bar:	22 Dia.										

Steelworx levers are supplied with bolt through fixings and should be used in conjunction with BTL's on P389. and Eurospec locks. For matching escutcheons SSE/SSP/SSU1405 see P66. For matching bathroom turn SST1415 see P66.

STEELWORX® 304 STAINLESS STEEL















SSL1407

SQUARE ELLIPSE LEVER ON SPRUNG ROSE
 Concealed Fix
 Square Press-on-Rose

Dimensions (mm):
 Rose: 54x54
 Rose Thickness: 8
 Projection: 73
 Lever Length: 135

 **SSS**











SSE/SSP/SSU1405/DUO





ESCUTCHEON
 Concealed Fix Square Press-on-Rose

Dimensions (mm):
 Rose: 52x52
 Rose Thickness: 8

SSE1404/DUO Euro
SSP1405/DUO Lock
SSU1405/DUO Oval

 **BSS/SSS**  **SSS**









SST1415/DUO

THUMBTURN AND RELEASE
 Concealed Fix Square Press-on-Rose

Dimensions (mm):
 Rose: 52x52
 Rose Thickness: 8



Variations:
SST1415i/DUO With Indicator



 **BSS/SSS**  **SSS**



Grade 304 Stainless Steel Levers on Screw on Rose



STEELWORX® 304 STAINLESS STEEL





		SWL1006DUO										
<p>ASTORIA Solid Lever on Round Rose Concealed Fix 2 Part Screw-on-Rose</p> <p>Dimensions (mm):</p> <table> <tr><td>Rose:</td><td>52 Dia.</td></tr> <tr><td>Rose Thickness:</td><td>7</td></tr> <tr><td>Projection:</td><td>62</td></tr> <tr><td>Lever Length:</td><td>135</td></tr> <tr><td>Bar:</td><td>19 Dia.</td></tr> </table> <p> BSS/SSS</p>			Rose:	52 Dia.	Rose Thickness:	7	Projection:	62	Lever Length:	135	Bar:	19 Dia.
Rose:	52 Dia.											
Rose Thickness:	7											
Projection:	62											
Lever Length:	135											
Bar:	19 Dia.											

		SWL1008DUO										
<p>VALIANT Solid Lever on Round Rose Concealed Fix 2 Part Screw-on-Rose</p> <p>Dimensions (mm):</p> <table> <tr><td>Rose:</td><td>52 Dia.</td></tr> <tr><td>Rose Thickness:</td><td>7</td></tr> <tr><td>Projection:</td><td>54</td></tr> <tr><td>Lever Length:</td><td>134</td></tr> <tr><td>Bar:</td><td>19 Dia.</td></tr> </table> <p> BSS/SSS</p>			Rose:	52 Dia.	Rose Thickness:	7	Projection:	54	Lever Length:	134	Bar:	19 Dia.
Rose:	52 Dia.											
Rose Thickness:	7											
Projection:	54											
Lever Length:	134											
Bar:	19 Dia.											

		SWL1009DUO										
<p>LUCERNA Solid Lever on Round Rose Concealed Fix 2 Part Screw-on-Rose</p> <p>Dimensions (mm):</p> <table> <tr><td>Rose:</td><td>52 Dia.</td></tr> <tr><td>Rose Thickness:</td><td>7</td></tr> <tr><td>Projection:</td><td>60</td></tr> <tr><td>Lever Length:</td><td>133</td></tr> <tr><td>Bar:</td><td>19 Dia.</td></tr> </table> <p> BSS/SSS</p>			Rose:	52 Dia.	Rose Thickness:	7	Projection:	60	Lever Length:	133	Bar:	19 Dia.
Rose:	52 Dia.											
Rose Thickness:	7											
Projection:	60											
Lever Length:	133											
Bar:	19 Dia.											

STEELWORX® 304 STAINLESS STEEL











SWL1010DUO





BERNA
Solid Lever on Round Rose
Concealed Fix 2 Part Screw-on-Rose

Dimensions (mm):

Rose:	52 Dia.
Rose Thickness:	7
Projection:	62
Lever Length:	136
Bar:	19 Dia.

 **BSS/SSS**











SWL1121





BREEZE
Lever on Round Rose
Concealed Fix 2 Part Screw-on-Rose

Dimensions (mm):

Rose:	52 Dia.
Rose Thickness:	7
Projection:	64
Lever Length:	127

 **SSS**









SWL1122

BREMA
Solid Lever on Round Rose
Concealed Fix 2 Part Screw-on-Rose

Dimensions (mm):

Rose:	52 Dia.
Rose Thickness:	7
Projection:	64
Lever Length:	135

 **SSS**

Steelworx levers are supplied with bolt through fixings and should be used in conjunction with BTL's on P389. and Eurospec locks. For matching bathroom turns SWT1016/1016i and SWT1025i see P77.

STEELWORX® 304 STAINLESS STEEL



SWL1126

MUNICH

Lever on Round Rose
Concealed Fix 2 Part Screw-on-Rose

Dimensions (mm):

Rose:	52 Dia.
Rose Thickness:	7
Projection:	65
Lever Length:	133
Bar:	19 Dia.

■ BSS ■ SSS



SWL1127

PENINSULA

Lever on Round Rose
Concealed Fix 2 Part Screw-on-Rose

Dimensions (mm):

Rose:	52 Dia.
Rose Thickness:	7
Projection:	62
Lever Length:	124

■ SSS



SWL1131

TIROL







Solid Lever on Round Rose
Concealed Fix 2 Part Screw-on-Rose









Dimensions (mm):







Rose:	52 Dia.
Rose Thickness:	7
Projection:	57
Lever Length:	120

■ SSS

STEELWORX® 304 STAINLESS STEEL

     	SWL1132
	<p>BERLINO DDA COMPLIANT Solid Lever on Round Rose Concealed Fix 2 Part Screw-on-Rose</p> <p>Dimensions (mm): Rose: 52 Dia. Rose Thickness: 7 Projection: 59 Lever Length: 127</p> <p> SSS</p>

      	SWL1133
	<p>ZURIGO DDA COMPLIANT Solid Lever on Round Rose Concealed Fix 2 Part Screw-on-Rose</p> <p>Dimensions (mm): Rose: 52 Dia. Rose Thickness: 7 Projection: 57 Lever Length: 125</p> <p> SSS</p>

    	SWL1134
	<p>CARLTON Lever on Round Rose Concealed Fix 2 Part Screw-on-Rose</p> <p>Dimensions (mm): Rose: 52 Dia. Rose Thickness: 7 Projection: 60 Lever Length: 128</p> <p> SSS</p>

Steelworx levers are supplied with bolt through fixings and should be used in conjunction with BTL's on P389, and Eurospec locks. For matching bathroom turns SWT102/103 see P76. For matching bathroom turns SWT1016/1016i and SWT1025i see P76.

STEELWORX® 304 STAINLESS STEEL



SWL1135

LUENZA DDA COMPLIANT

Lever on Round Rose
Concealed Fix 2 Part Screw-on-Rose

Dimensions (mm):

Rose:	52 Dia.
Rose Thickness:	7
Projection:	65
Lever Length:	133



SWL1160

PLAZA

Lever on Round Rose
Concealed Fix 2 Part Screw-on-Rose

Dimensions (mm):

Rose:	52 Dia.
Rose Thickness:	7
Projection:	71
Lever Length:	133



SWL1161

LUBECCA



Solid Lever on Round Rose
Concealed Fix 2 Part Screw-on-Rose





Dimensions (mm):





Rose:	52 Dia.
Rose Thickness:	7
Projection:	66
Lever Length:	128



STEELWORX® 304 STAINLESS STEEL

	SWL1162
	<p>LONDRA Lever on Round Rose Concealed Fix 2 Part Screw-on-Rose</p> <p>Dimensions (mm): Rose: 52 Dia. Rose Thickness: 7 Projection: 58 Lever Length: 135</p> <p> SSS</p>





	SWL1164
	<p>CUTLASS DDA COMPLIANT Lever on Round Rose Concealed Fix 2 Part Screw-on-Rose</p> <p>Dimensions (mm): Rose: 52 Dia. Rose Thickness: 7 Projection: 62 Lever Length: 134</p> <p> BSS  SSS</p>

	SWL1165
	<p>SCIMITAR DDA COMPLIANT Lever on Round Rose Concealed Fix 2 Part Screw-on-Rose</p> <p>Dimensions (mm): Rose: 52 Dia. Rose Thickness: 7 Projection: 67 Lever Length: 135</p> <p> BSS  SSS</p>

Steelworx levers are supplied with bolt through fixings and should be used in conjunction with BTL's on P389. and Eurospec locks. For matching escutcheons SWL102/103 see P76. For matching bathroom turns SWT1016/1016i and SWT1025i see P77.

STEELWORX® 304 STAINLESS STEEL



SWL1166

CERVINO
Lever on Round Rose
Concealed Fix 2 Part Screw-on-Rose





Dimensions (mm):

Rose:	52 Dia.
Rose Thickness:	7
Projection:	68
Lever Length:	127

BSS

SSS



SWL1167DUO





SHORE
Lever on Round Rose
Concealed Fix 2 Part Screw-on-Rose

Dimensions (mm):

Rose:	52 Dia.
Rose Thickness:	7
Projection:	65
Lever Length:	140
Bar:	19 Dia.

BSS/SSS



SWL1168

PARIGI
Lever on Round Rose
Concealed Fix 2 Part Screw-on-Rose

Dimensions (mm):

Rose:	52 Dia.
Rose Thickness:	7
Projection:	62
Lever Length:	127

SSS

STEELWORX® 304 STAINLESS STEEL

--	--	--	--	--	--	--



SWL1190

NERA DDA COMPLIANT
Lever on Round Rose
Concealed Fix 2 Part Screw-on-Rose

Dimensions (mm):
 Rose: 52 Dia.
 Rose Thickness: 7
 Projection: 65
 Lever Length: 140
 Bar: 19 Dia.

BSS SSS

--	--	--	--	--	--



SWL1191

SPIRA
Lever on Round Rose
Concealed Fix 2 Part Screw-on-Rose

Dimensions (mm):
 Rose: 52 Dia.
 Rose Thickness: 66
 Lever Length: 133
 Bar: 19 Dia.

BSS SSS

--	--	--	--	--



SWL1192





TREVIRI
Lever on Round Rose
Concealed Fix 2 Part Screw-on-Rose



Dimensions (mm):
 Rose: 52 Dia.
 Rose Thickness: 7
 Projection: 65
 Lever Length: 128
 Bar: 19 Dia.





BSS/SSS SSS

Steelworx levers are supplied with bolt through fixings and should be used in conjunction with BTL's on P389. and Eurospec locks. For matching escutcheons SWL102/103 see P76. For matching bathroom turns SWT1016/1016i and SWT1025i see P77.

STEELWORX® 304 STAINLESS STEEL

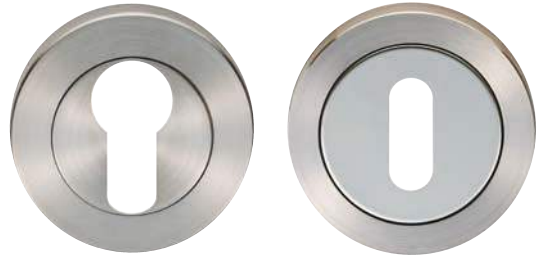
		<p>SWL1194</p> <p>PHILADELPHIA Lever on Round Rose Concealed Fix 2 Part Screw-on-Rose</p> <p>Dimensions (mm): Rose: 52 Dia. Rose Thickness: 7 Projection: 65 Lever Length: 137 Bar: 19 Dia.</p> <p> BSS/SSS  SSS</p>
-----------------------------------------------------------------------------------	-----------------------------------------------------------------------------------	-----------------------------------------------------------------------------------------------------------------------------------------------------------------------------------------------------------------------------------------------------------------------------------------------------------------------------------------------------------------------------------------------------------------------------------------------------------

		<p>SWL1196</p> <p>DRESDA Lever on Round Rose Concealed Fix 2 Part Screw-on-Rose</p> <p>Dimensions (mm): Rose: 52 Dia. Rose Thickness: 7 Projection: 65 Lever Length: 128</p> <p> SSS</p>
------------------------------------------------------------------------------------	-----------------------------------------------------------------------------------	-----------------------------------------------------------------------------------------------------------------------------------------------------------------------------------------------------------------------------------------------------------------------------------------------------------------------------------

		<p>SWL102/103</p> <p>ESCUTCHEON Concealed Fix 2 Part Screw-on-Rose</p> <p>Dimensions (mm): Rose: 52 Dia. Rose Thickness: 7</p> <p>SWL102 Euro SWL103 Lock</p> <p> BSS  SSS</p> <p> BSS/SSS</p>
-------------------------------------------------------------------------------------	-------------------------------------------------------------------------------------	---------------------------------------------------------------------------------------------------------------------------------------------------------------------------------------------------------------------------------------------------------------------------------------------------------------------------------------------------------------------------------------------------------------------------------------------------------------------------------------------------------------------------------------

STEELWORX® 304 STAINLESS STEEL



SWT1016

THUMBTURN AND RELEASE
Concealed Fix 2 Part Screw-on-Rose

Dimensions (mm):
Rose: 52 Dia.
Rose Thickness: 7

Variations:
SST1016i With Indicator

BSS SSS

BSS/SSS



SWT1025i

DDA COMPLIANT THUMBTURN AND RELEASE
Concealed Fix 2 Part Screw-on-Rose

Dimensions (mm):
Rose: 52 Dia.
Rose Thickness: 7

BSS SSS

BSS/SSS

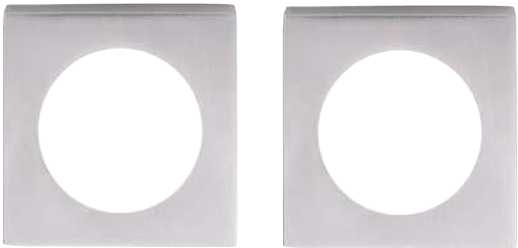

SWR1137

SQUARE ROSE PACK
Supplied in Pairs
Grub Screw Fixing

Dimensions (mm):
Rose: 52 Dia.
Rose Thickness: 7







BSS SSS

Grade 316 Stainless Steel Levers on Screw on Rose



STEELWORX® 316 STAINLESS STEEL



SW10

STRAIGHT
Lever on Round Bearing Rose
Concealed Fix 2 Part Screw-on-Rose







Dimensions (mm):
 Rose: 50 Dia.
 Rose Thickness: 6
 Projection: 65
 Lever Length: 133
 Bar: 16 Dia.

Variations:
SW12 Bar 19 Dia.
SW124 Sprung - Bar 19 Dia.

BSS

SSS



SW11

SAFETY DDA COMPLIANT
Lever on Round Bearing Rose
Concealed Fix 2 Part Screw-on-Rose

Dimensions (mm):
 Rose: 50 Dia.
 Rose Thickness: 6
 Projection: 66
 Lever Length: 140
 Bar: 19 Dia.

Variations:
SW15 Bar 22 Dia.
SW122 Sprung - Bar 16 Dia.
SW123 Sprung - Bar 19 Dia.
SW127 Sprung - Bar 22 Dia.

BSS

SSS

Steelworx levers are supplied with bolt through fixings and should be used in conjunction with BTL's on P389 and Eurospec locks. For matching escutcheons SW102-104 see P84. For matching bathroom turns SW105/i and 107/i see P84. SW10,15 and 122 not available in BSS finish. SW122 not DDA Compliant.

STEELWORX® 316 STAINLESS STEEL



SW13



MITRED

Lever on Round Bearing Rose
Concealed Fix 2 Part Screw-on-Rose

Dimensions (mm):

Rose: 50 Dia.
Rose Thickness: 6
Projection: 66
Lever Length: 135
Bar: 19 Dia.

Variations:

SW125 Sprung - Bar 19 Dia.



SW14



CURVED

Lever on Round Bearing Rose
Concealed Fix 2 Part Screw-on-Rose

Dimensions (mm):









Rose: 50 Dia.
Rose Thickness: 6
Projection: 67
Lever Length: 135
Bar: 19 Dia.









Variations:

SW126 Sprung - Bar 19 Dia.



STEELWORX® 316 STAINLESS STEEL

     	SW16								
	<p>DESIGNER Lever on Round Bearing Rose Concealed Fix 2 Part Screw-on-Rose</p> <p>Dimensions (mm):</p> <table border="0"> <tr> <td>Rose:</td> <td>50 Dia.</td> </tr> <tr> <td>Rose Thickness:</td> <td>6</td> </tr> <tr> <td>Projection:</td> <td>70</td> </tr> <tr> <td>Lever Length:</td> <td>115</td> </tr> </table> <p> SSS</p>	Rose:	50 Dia.	Rose Thickness:	6	Projection:	70	Lever Length:	115
	Rose:	50 Dia.							
Rose Thickness:	6								
Projection:	70								
Lever Length:	115								

     	SW18										
	<p>CARBON FIBRE Lever on Round Bearing Rose - Solid Concealed Fix 2 Part Screw-on-Rose</p> <p>Dimensions (mm):</p> <table border="0"> <tr> <td>Rose:</td> <td>50 Dia.</td> </tr> <tr> <td>Rose Thickness:</td> <td>6</td> </tr> <tr> <td>Projection:</td> <td>65</td> </tr> <tr> <td>Lever Length:</td> <td>124</td> </tr> <tr> <td>Bar:</td> <td>19 Dia.</td> </tr> </table> <p> SSS</p>	Rose:	50 Dia.	Rose Thickness:	6	Projection:	65	Lever Length:	124	Bar:	19 Dia.
	Rose:	50 Dia.									
Rose Thickness:	6										
Projection:	65										
Lever Length:	124										
Bar:	19 Dia.										

Steelworx levers are supplied with bolt through fixings and should be used in conjunction with BTL's on P389. and Eurospec locks. For matching escutcheons SW101-104 see P84. For matching bathroom turns SW105/i and 107/i see P84.

STEELWORX® 316 STAINLESS STEEL



SW19



DESIGNER

Lever on Round Bearing Rose - Solid Concealed Fix 2 Part Screw-on-Rose

Dimensions (mm):

Rose: 50 Dia.
 Rose Thickness: 6
 Projection: 64
 Lever Length: 135



SSS



SW120



DESIGNER

Lever on Round Bearing Rose - Solid Concealed Fix 2 Part Screw-on-Rose







Dimensions (mm):

Rose: 50 Dia.
 Rose Thickness: 6
 Projection: 72
 Lever Length: 124



SSS

STEELWORX® 316 STAINLESS STEEL







							SW140
-----------------------------------------------------------------------------------	-----------------------------------------------------------------------------------	-----------------------------------------------------------------------------------	-----------------------------------------------------------------------------------	-----------------------------------------------------------------------------------	-----------------------------------------------------------------------------------	------------------------------------------------------------------------------------	--------------



DESIGN LEVER
DDA COMPLIANT
 Lever on Round Bearing Rose
 Concealed Fix 2 Part Screw-on-Rose

Dimensions (mm):
 Rose: 50 Dia.
 Rose Thickness: 6
 Projection: 71
 Lever Length: 147

 **SSS**

							SW141
-------------------------------------------------------------------------------------	-------------------------------------------------------------------------------------	-------------------------------------------------------------------------------------	-------------------------------------------------------------------------------------	-------------------------------------------------------------------------------------	-------------------------------------------------------------------------------------	--------------------------------------------------------------------------------------	--------------



DESIGN LEVER
DDA COMPLIANT
 Lever on Round Bearing Rose
 Concealed Fix 2 Part Screw-on-Rose







Dimensions (mm):
 Rose: 50 Dia.
 Rose Thickness: 6
 Projection: 67
 Lever Length: 144





 **SSS**

Steelworx levers are supplied with bolt through fixings and should be used in conjunction with BTL's on P389. and Eurospec locks. For matching escutcheons SW102-104 see P84. For matching bathroom turns SW105/i and 107/i see P84.









STEELWORX® 316 STAINLESS STEEL







	   	SW102/3/4
	<p>ESCUTCHEON Concealed Fix 2 Part Screw-on-Rose</p> <p>Dimensions (mm): Rose: 50 Dia. Rose Thickness: 6</p> <p>SW102 Euro SW103 Lock SW104 Oval</p> <p style="text-align: center;"> BSS SSS </p>	

	    	SW105
	<p>DDA COMPLIANT THUMBTURN AND RELEASE Concealed Fix 2 Part Screw-on-Rose</p> <p>Dimensions (mm): Rose: 50 Dia. Rose Thickness: 6</p> <p>Variations: SW105i With Indicator</p> <p style="text-align: center;"> BSS SSS </p>	

	   	SW107
	<p>DESIGNER THUMBTURN AND RELEASE Concealed Fix 2 Part Screw-on-Rose</p> <p>Dimensions (mm): Rose: 50 Dia. Rose Thickness: 6</p> <p>Variations: SW106i With Indicator</p> <p style="text-align: center;"> BSS SSS </p>	

STEELWORX® 316 STAINLESS STEEL

      	SW4123X
	<p>GRADE 4 SAFETY LEVER DDA COMPLIANT Lever on Round Bearing Rose Concealed Fix 2 Part Screw-on-Rose</p> <p>Dimensions (mm): Rose: 53 Dia. Rose Thickness: 8 Projection: 67 Lever Length: 140</p> <p> SSS</p>

   	ESE1005
	<p>ESCUTCHEON Concealed Fix 2 Part Screw-on-Rose</p> <p>Dimensions (mm): Rose: 53 Dia. Rose Thickness: 8</p> <p> SSS</p>

SW4123X thumbturn and release options available. Contact our sales office on 01228 511030 for details.

Grade 304 Stainless Steel Pull Handles



STEELWORX® 304 STAINLESS STEEL







CSD

D PULL HANDLE

Dimensions (mm):

CSD1150	150c/c - Bar 19 Dia.
CSD1225	225c/c - Bar 19 Dia.
CSD1300	300c/c - Bar 19 Dia.
CSD1425	425c/c - Bar 19 Dia.
CSD1450	450c/c - Bar 19 Dia.
CSD1600	600c/c - Bar 19 Dia.
CFD1150	150c/c - Bar 22 Dia.
CFD1225	225c/c - Bar 22 Dia.
CFD1450	450c/c - Bar 22 Dia.
CFD1600	600c/c - Bar 22 Dia.

BSS

SSS







SWP1134

CARLTON PULL HANDLE

Dimensions (mm):

SWP1134/225	225c/c
SWP1134/300	300c/c
SWP1134/450	450c/c
SWP1134/600	600c/c

SSS

CFD1450 and CFD1600 are not available in BSS finish. CSD1450 and CSD1600 are DDA Compliant. Back to back fixing packs BBF1019/22 available. Bolt cap fixing packs SBF1019/22 available - ideal for glass and aluminium doors. Extension bolt BBF100BOLT available. Rose kit CSR1005 available.

STEELWORX® 304 STAINLESS STEEL







SSD

SQUARE T PULL HANDLE

Variations:

SSD1415	150c/c
SSD1422	225c/c
SSD1430	300c/c
SSD1445	450c/c
SSD1460	600c/c

 **BSS/SSS**







SSF

FLAT T PULL HANDLE

Variations:

SSF1415	150c/c
SSF1422	225c/c
SSF1430	300c/c
SSF1445	450c/c
SSF1460	600c/c

 **SSS**

STEELWORX® 304 STAINLESS STEEL



SSM

SQUARE MITRED PULL HANDLE

Variations:

SSM1415	150c/c
SSM1422	225c/c
SSM1430	300c/c
SSM1445	450c/c
SSM1460	600c/c

SSS

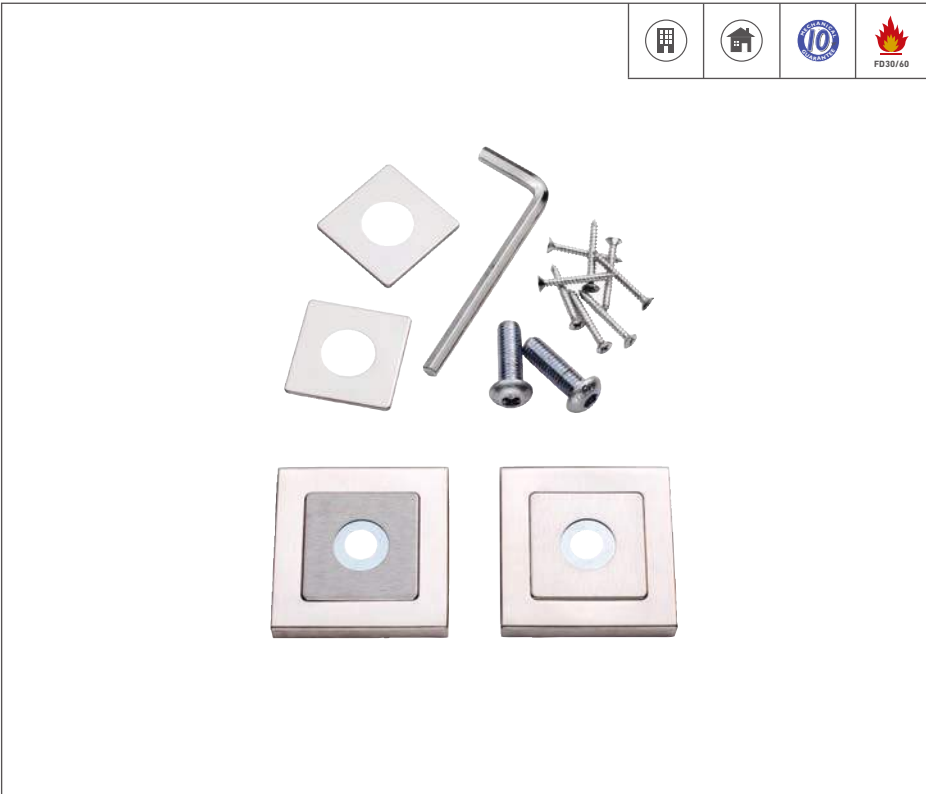

SSR1405SSS/DUO

ROSE KIT

Dimensions (mm):

Rose:	52x52
Rose Thickness:	8

BSS/SSS **SSS**

SSM1445 and SSM1460 are DDA Compliant. Back to back fixing pack BBF1019SQ available.
 SSM for matching lever SSL1401 see P64.
 SSR1405SSS/DUO is supplied with both a polished and satin inner to allow for a single or dual finish.

Grade 316 Stainless Steel Pull Handles



STEELWORX® 316 STAINLESS STEEL









PAC/PFC/PBC/PCC

CRANKED PULL HANDLE

Variations:

PAC1225	225c/c - Bar 19 Dia.
PAC1300	300c/c - Bar 19 Dia.
PAC1600	600c/c - Bar 19 Dia.
PFC1300	300c/c - Bar 22 Dia.
PBC1300	300c/c - Bar 25 Dia.
PCC1450	450c/c - Bar 30 Dia.
PCC1600	600c/c - Bar 30 Dia.

SSS









PAD/PFD/PBD/PCD

D PULL HANDLE

Variations:

PAD1150	150c/c - Bar 19 Dia.
PAD1225	225c/c - Bar 19 Dia.
PAD1300	300c/c - Bar 19 Dia.
PAD1450	450c/c - Bar 19 Dia.
PAD1600	600c/c - Bar 19 Dia.
PFD1225	225c/c - Bar 22 Dia.
PFD1300	300c/c - Bar 22 Dia.
PBD1225	225c/c - Bar 25 Dia.
PBD1300	300c/c - Bar 25 Dia.
PBD1450	450c/c - Bar 25 Dia.
PBD1600	600c/c - Bar 25 Dia.
PCD1450	450c/c - Bar 30 Dia.
PCD1600	600c/c - Bar 30 Dia.
PCD11800	1800c/c - Bar 30 Dia.

BSS**SSS**

PAC1225, PAC1600, PFC1300, PBC1300, PCC1450 AND PCC1600 not available in BSS finish.

PAD1450, PAD1600, PFD1225, PCD1600 and PCD11800 not available in BSS finish.

PAC1600, PCC1450, PCC1600, PAD1450, PAD1600, PCD1450 and PCD1600 are DDA compliant.

Back to back fixing packs BBF1019/22/25/30 available. Bolt cap fixing packs SBF1019/22/25/30 available - ideal for glass and aluminium doors. Extension bolt BBF100BOLT available. Rose kit SW134 available in all finishes.

STEELWORX® 316 STAINLESS STEEL



PAT/PBT/PCT/PFT

T PULL HANDLE

Variations:

PAT1225	225c/c - Bar 19 Dia.
PAT1300	300c/c - Bar 19 Dia.
PFT1225	225c/c - Bar 22 Dia.
PFT1300	300c/c - Bar 22 Dia.
PBT1225	225c/c - Bar 25 Dia.
PBT1300	300c/c - Bar 25 Dia.
PCT1450	450c/c - Bar 30 Dia.
PCT1600	600c/c - Bar 30 Dia.
PCT1900	900c/c - Bar 30 Dia.
PCT11200	1000c/c - Bar 30 Dia.
PCT11800	1630c/c - Bar 30 Dia.

BSS
 SSS



PAM

MITRED PULL HANDLE

Variations:

PAM1300	300c/c - Bar 19 Dia.
PCM1450	450c/c - Bar 30 Dia.
PCM1600	600c/c - Bar 30 Dia.

SSS

STEELWORX® 316 STAINLESS STEEL



PBG

SEMI CIRCULAR PULL HANDLE

Dimensions (mm):

PBG1250 250c/c - Bar 25 Dia.
PBG1350 350c/c - Bar 30 Dia.

 **SSS**



SWP18

CARBON FIBRE PULL HANDLE
Solid

Variations:

SWP18/300 300c/c
SWP18/600 600c/c

 **SSS**

Back to back fixing packs BBF25/30 available.
 Bolt cap fixing packs SBF1019/22/25/30 available - ideal for glass and aluminium doors.
 Rose kit SW134 available in all finishes. SWP18 for matching lever SW18 see P81.

STEELWORX® 316 STAINLESS STEEL



SWP19

DESIGNER PULL HANDLE

Solid

Dimensions:

Rose: 50 Dia.

Variations:

SWP19/300 300c/c

SWP19/600 600c/c



SSS



SW134

ROSE KIT

Dimensions (mm):

Rose: 50

Rose Thickness: 6





BSS



SSS

Grade 304 Stainless Steel Levers on Backplate









STEELWORX® 304 STAINLESS STEEL

			CSLP1190								
			<p>SAFETY LEVER ON INNER PLATE</p> <p>Dimensions (mm):</p> <table border="0"> <tr><td>Backplate:</td><td style="text-align: right;">170x45</td></tr> <tr><td>Projection:</td><td style="text-align: right;">66</td></tr> <tr><td>Lever Length:</td><td style="text-align: right;">140</td></tr> <tr><td>Bar:</td><td style="text-align: right;">19 Dia.</td></tr> <tr><td>Plate Thickness:</td><td style="text-align: right;">8</td></tr> </table>		Backplate:	170x45	Projection:	66	Lever Length:	140	Bar:
Backplate:	170x45										
Projection:	66										
Lever Length:	140										
Bar:	19 Dia.										
Plate Thickness:	8										
CSLP1190 + CPRE1170			<input type="checkbox"/> BSS <input type="checkbox"/> SSS								

			CSLP1191								
			<p>STRAIGHT LEVER ON INNER PLATE</p> <p>Dimensions (mm):</p> <table border="0"> <tr><td>Backplate:</td><td style="text-align: right;">170x45</td></tr> <tr><td>Projection:</td><td style="text-align: right;">66</td></tr> <tr><td>Lever Length:</td><td style="text-align: right;">133</td></tr> <tr><td>Bar:</td><td style="text-align: right;">19 Dia.</td></tr> <tr><td>Plate Thickness:</td><td style="text-align: right;">8</td></tr> </table>		Backplate:	170x45	Projection:	66	Lever Length:	133	Bar:
Backplate:	170x45										
Projection:	66										
Lever Length:	133										
Bar:	19 Dia.										
Plate Thickness:	8										
CSLP1191 + CPSP1170			<input type="checkbox"/> BSS <input type="checkbox"/> SSS								

STEELWORX® 304 STAINLESS STEEL





	CODE	DESCRIPTION
	CPRB1170	Radius Latch Plate
	CPRE1170/72	Radius Euro Plate - Din 72 c/c
	CPRE1170	Radius Euro Plate - 47.5 c/c
	CPRP1170	Radius Lock Plate
	CPRT1170/78	Radius Bathroom Plate - Din 78 c/c + Small Indicator + Turn
	CPRT1170	Radius Bathroom Plate - UK 57 c/c + Small Indicator + Turn
	CPRTL1170/78	Radius Bathroom Plate - Din 78 c/c + Large Indicator + Turn
	CPRTL1170	Radius Bathroom Plate - UK 57 c/c + Large Indicator + Turn
	CPRU1170	Radius UK Oval Plate - 48.5 c/c
	CPSB1170	Square Latch Plate
	CPSE1170/72	Square Euro Plate - Din 72 c/c
	CPSE1170	Square Euro Plate - 47.5 c/c
	CPSP1170	Square Lock Plate
	CPST1170/78	Square Bathroom Plate - Din 78 c/c + Small Indicator + Turn
	CPST1170	Square Bathroom Plate - UK 57 c/c + Small Indicator + Turn
	CPSTL1170/78	Square Bathroom Plate - Din 78 c/c + Large Indicator + Turn
	CPSTL1170	Square Bathroom Plate - UK 57 c/c + Large Indicator + Turn
	CPSU1170	Square UK Oval Plate - 48.5 c/c

Grade 201 Stainless Steel Levers on Backplate



STEELWORX® 201 STAINLESS STEEL



CSLP1162B

MITRED
Lever on Latch Backplate

Dimensions (mm):
 Backplate: 172x42
 Projection: 62
 Lever Length: 120
 Bar: 16 Dia.
 Plate Thickness: 8

Variations:
CSLP1162E Euro 47.5c/c
CSLP1162P Lock
CSLP1162T Bathroom

BSS

SSS









CSLP1163EDUO

CURVED
Lever on Euro Backplate





Dimensions (mm):
 Backplate: 172x42
 Projection: 62
 Lever Length: 119
 Bar: 16 Dia.
 Plate Thickness: 8

Variations:
CSLP1163B Latch
CSLP1163P Lock
CSLP1163T Bathroom

BSS/SSS

STEELWORX® 201 STAINLESS STEEL



CSLP1164P





T-BAR
Lever on Lock Backplate

Dimensions (mm):
 Backplate: 172x42
 Projection: 62
 Lever Length: 120
 Bar: 16 Dia.
 Plate Thickness: 8

Variations:
CSLP1164B Latch
CSLP1164E Euro 47.5c/c
CSLP1164T Bathroom

BSS SSS



CSLP1167T

ARCHED
Lever on Bathroom Backplate

Dimensions (mm):
 Backplate: 172x42
 Projection: 62
 Lever Length: 122
 Bar: 16 Dia.
 Plate Thickness: 8











Variations:
CSLP1167B Latch
CSLP1167E Euro 47.5c/c
CSLP1167P Lock







BSS SSS

Grade 316 Stainless Steel Levers on Backplate



STEELWORX® 316 STAINLESS STEEL

  SWLP123 + SWOB	      	SWLP123									
	<p>SAFETY LEVER ON INNER PLATE</p> <p>Dimensions (mm):</p> <table> <tr> <td>Backplate:</td> <td>180x45</td> </tr> <tr> <td>Projection:</td> <td>62</td> </tr> <tr> <td>Lever Length:</td> <td>138</td> </tr> <tr> <td>Bar:</td> <td>19 Dia.</td> </tr> <tr> <td>Plate Thickness:</td> <td>6</td> </tr> </table>		Backplate:	180x45	Projection:	62	Lever Length:	138	Bar:	19 Dia.	Plate Thickness:
Backplate:	180x45										
Projection:	62										
Lever Length:	138										
Bar:	19 Dia.										
Plate Thickness:	6										
		 SSS									

	CODE	DESCRIPTION
	SWOB	Radius Latch Plate
	SWOE	Radius Euro Plate - 47.5 c/c
	SWOT	Radius Bathroom Plate - UK 57 c/c + Small Indicator + Turn
	SWOP	Radius Lock Plate
	SWOU	Radius UK Oval Plate - 48.5 c/c
	SWOE/72	Radius Euro Plate - Din 72 c/c
	SWOT/78	Radius Bathroom Plate - Din 78 c/c + Large Indicator + Turn

Stainless Steel Ancilliary Door Furniture



STEELWORX® STAINLESS STEEL







FPP1300

PLAIN FINGER PLATE





Dimensions (mm):
Plate: 300x75

Variations:

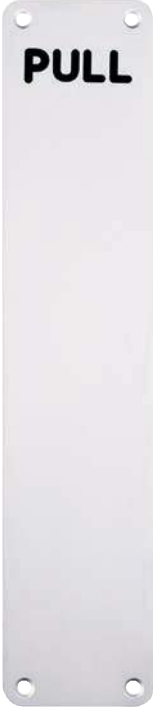
FPP1350	350x75
FPP1500	500x75
FPP1650	650x75

BSS
 SSS



FPP1301

PULL FINGER PLATE



Dimensions (mm):
Plate: 300x75







Variations:

FPP1351	350x75
----------------	--------







BSS
 SSS









STEELWORX® STAINLESS STEEL

 <p>PUSH</p>	   	FPP1302
	<p>PUSH FINGER PLATE</p> <p>Dimensions (mm): Plate: 300x75</p> <p>Variations: FPP1352 350x75</p> <p style="text-align: center;"> <input type="checkbox"/> BSS <input type="checkbox"/> SSS </p>	

	    	CSK1058
	<p>MORTICE KNOB On Sprung Rose</p> <p>Dimensions (mm): Rose: 55 Dia.</p> <p style="text-align: center;"> <input type="checkbox"/> BSS <input type="checkbox"/> SSS </p>	



STEELWORX® STAINLESS STEEL



			 BS EN 1906		 FD30/60	<p>SSK1062</p> <p>MORTICE KNOB On Sprung Rose</p> <p>Dimensions (mm): Rose: 52x52 Knob: 62x62 Projection: 68</p> <p> SSS</p>

			 BS EN 1906		 FD30/60	<p>SWKNR1058</p> <p>MORTICE KNOB GRADE 316 Unsprung</p> <p>Dimensions (mm): Rose: 50 Dia. Knob: 55 Dia. Projection: 80</p> <p> BSS  SSS</p>

STEELWORX® 316 STAINLESS STEEL



SWNP11

**DDA COMPLIANT SAFETY LEVER
NARROW PLATE**

Dimensions (mm):

Backplate:	220x32
Projection:	66
Lever Length:	140
Bar:	19
Centres:	92
Plate Thickness:	6

SSS









SWNP120

**SAFETY LEVER
NARROW PLATE**

Dimensions (mm):

Backplate:	220x32
Projection:	72
Lever Length:	124
Centres:	92
Plate Thickness:	6

SSS

Narrow plate levers are suitable for multi-point locking systems.

STEELWORX® 316 STAINLESS STEEL

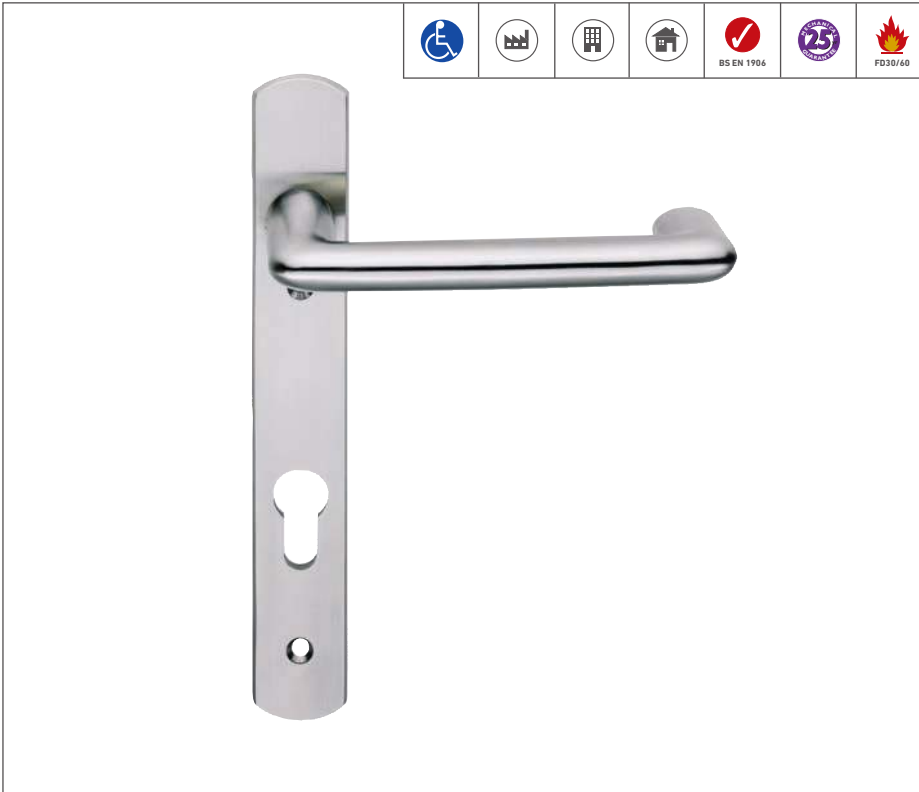

SWNP40

**DDA COMPLIANT
NARROW PLATE**

Dimensions (mm):

Backplate:	220x32
Projection:	71
Lever Length:	147
Centres:	92
Plate Thickness:	6



SSS

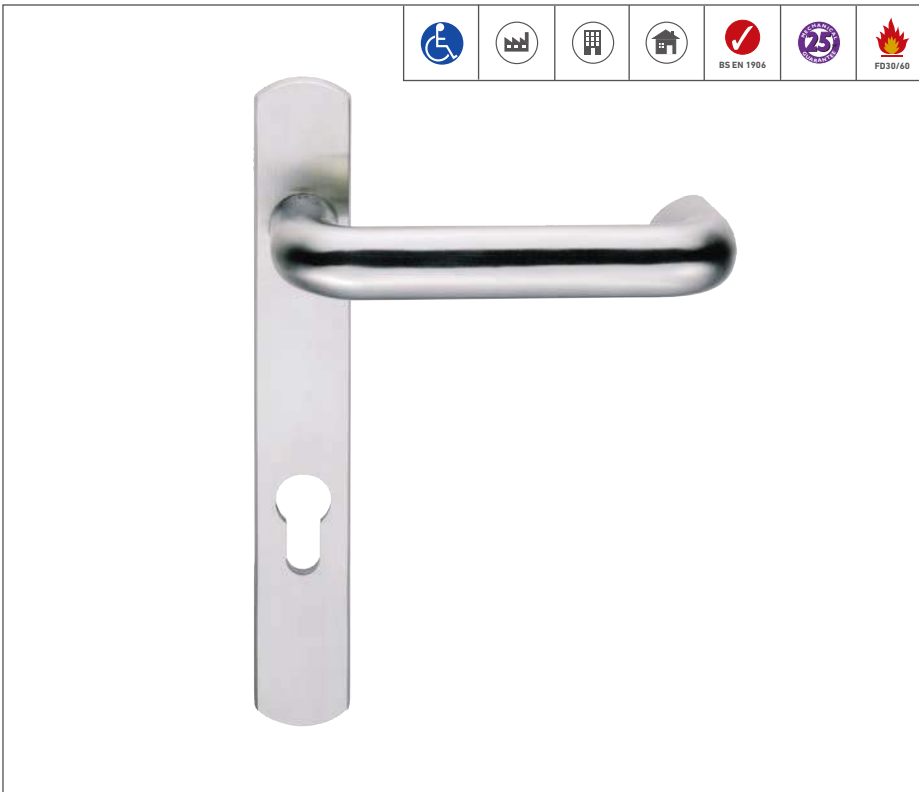

SWNP41

**DDA COMPLIANT SAFETY LEVER
NARROW PLATE**

Dimensions (mm):

Backplate:	220x32
Projection:	67
Lever Length:	144
Centres:	92
Plate Thickness:	6







SSS



Stainless Steel Ancilliary Door Furniture













STEELWORX® STAINLESS STEEL

		<p>SWE1000</p>
<p>DOOR VIEWER Suits doors 35-55mm thick</p> <p>Dimensions (mm): Lens: 14 Dia. Angle of Vision: 180°</p> <p> <input type="checkbox"/> BSS <input type="checkbox"/> SSS <input type="checkbox"/> PVD </p>		

		<p>SWE1010</p>
<p>DOOR VIEWER GRADE 316 Suits doors 35-60mm SWE1011 extension sleeve suits doors up to 100mm</p> <p>Dimensions (mm): Lens: 22 Dia. Angle of Vision: 200°</p> <p> <input type="checkbox"/> BSS <input type="checkbox"/> SSS <input type="checkbox"/> PVD </p>		

		<p>SWE1030</p>
<p>BELL PUSH GRADE 316</p> <p>Dimensions (mm): Plate: 64x30 Plate Thickness: 8</p> <p> <input type="checkbox"/> BSS <input type="checkbox"/> SSS <input type="checkbox"/> PVD </p>		

STEELWORX® STAINLESS STEEL

			 BS EN 1670		 FD120/240 STEEL	 FD30/60	SWE1020
	DOOR KNOCKER GRADE 316						
Dimensions (mm):							
Plate:						167x40	
Plate Thickness:						8	
 BSS  SSS  PVD							

			 BS EN 1670		 FD120/240 STEEL	 FD30/60	SWE1040
	CENTRE DOOR KNOB GRADE 316						
Dimensions (mm):							
Rose:						70 Dia.	
Knob:						70 Dia.	
Projection:						70	
 BSS  SSS  PVD							

SWE1040 supplied with 19x7mm concealed bolt fix cap.

STEELWORX® STAINLESS STEEL



SWE1050

SLEEVED LETTER PLATE

Suits doors up to 70mm

Dimensions (mm):

Letterplate: 300x70
 Outwards Opening: 180°
 Aperture Hole Required: 260x47
 Fixing Bolt Centres: 272

BSS SSS



SWE1062

SQUARE CENTRE DOOR KNOB

Dimensions (mm):

Rose: 62x62
 Knob: 61x61
 Projection: 65

SSS

STEELWORX® STAINLESS STEEL



KPP

KICKPLATE

Dimensions (mm):

Plate: 590x150
 Plate Thickness: 1.2

Variations:

KPP1590	590x150
KPP1615	615x150
KPP1650	650x150
KPP1675	675x150
KPP1690	690x150
KPP1715	715x150
KPP1725	725x150
KPP1750	750x150
KPP1790	790x150
KPP1805	805x150
KPP1815	815x150
KPP1830	830x150
KPP1855	855x150
KPP1880	880x150
KPP1890	890x150
KPP1905	905x150
KPP1915	915x150

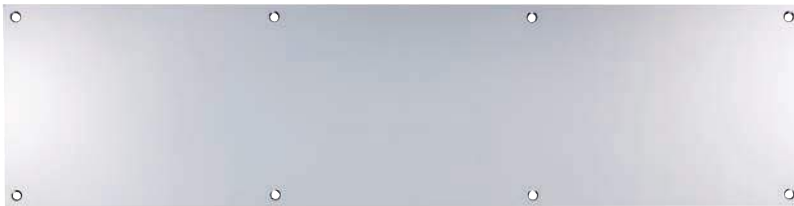

Kickplates are individually packed with matching pozi screws and corner protectors.



SIGNS

Dimensions (mm):



FPA1301	
Pull Symbol	75x30
FPA1302	
Push Symbol	75x30
SEX1011	
Male Symbol	76 Dia.
SEX1012	
Female Symbol	76 Dia.
SEX1014	
Shower Symbol	76 Dia.
SEX1015	
Fire Door Keep Locked	76 Dia.
SEX1016	
Fire Door Keep Shut	76 Dia.
SEX1017	
Disabled Symbol	76 Dia.
SEX1018	
Unisex Symbol	76 Dia.
SEX1019	
Baby Change Symbol	76 Dia.
SEX1020	
No Smoking Sign	210x148
SEX1021	
Fire Escape Sign	76 Dia.

■ BSS ■ SSS



STEELWORX® STAINLESS STEEL



LETTERS & NUMERALS
Dimensions (mm):

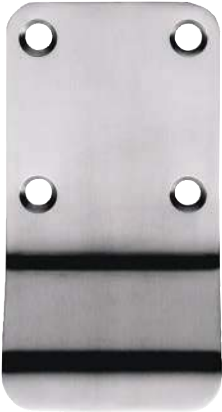

LET1050A	
Letter a	40
LET1050B	
Letter b	40
LET1050C	
Letter c	40
LET10100A	
Letter a	50
LET10100B	
Letter b	50
LET10100C	
Letter c	50
NUM10500	
Numeral 0	50
NUM10501	
Numeral 1	50
NUM10502	
Numeral 2	50
NUM10503	
Numeral 3	50
NUM10504	
Numeral 4	50
NUM10505	
Numeral 5	50
NUM10506/9	
Numeral 6/9	50
NUM10507	
Numeral 7	50
NUM10508	
Numeral 8	50
NUM10100	
Numeral 0	100
NUM10101	
Numeral 1	100
NUM10102	
Numeral 2	100
NUM10103	
Numeral 3	100
NUM10104	
Numeral 4	100
NUM10105	
Numeral 5	100
NUM10106/9	
Numeral 6/9	100
NUM10107	
Numeral 7	100
NUM10108	
Numeral 8	100

 **BSS**  **SSS**





STEELWORX® STAINLESS STEEL





		BCP1000
		<p>BLANK CYLINDER PULL</p> <p>Dimensions (mm): Overall: 78x44</p> <p style="text-align: center;"> <input type="checkbox"/> BSS <input type="checkbox"/> SSS </p>

		ECP1000
		<p>EURO CYLINDER PULL</p> <p>Dimensions (mm): Overall: 78x44</p> <p style="text-align: center;"> <input type="checkbox"/> BSS <input type="checkbox"/> SSS <input type="checkbox"/> PVD </p>

		OCP1000
		<p>OVAL CYLINDER PULL</p> <p>Dimensions (mm): Overall: 78x44</p> <p style="text-align: center;"> <input type="checkbox"/> BSS <input type="checkbox"/> SSS </p>

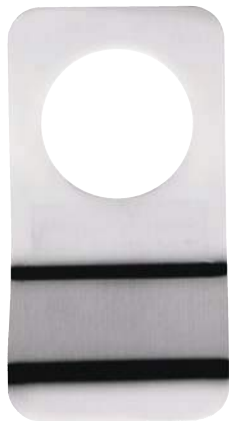
STEELWORX® STAINLESS STEEL





	   	PCP1000
		<p>LOCK CYLINDER PULL</p> <p>Dimensions (mm): Overall: 78x44</p> <p style="text-align: center;"> <input type="checkbox"/> BSS <input type="checkbox"/> SSS </p>

	   	RCP1000
		<p>RIM CYLINDER PULL</p> <p>Dimensions (mm): Overall: 78x44</p> <p style="text-align: center;"> <input type="checkbox"/> BSS <input type="checkbox"/> SSS </p>

Carlisle Brass Traditional Face Fix Levers on Rose





DL56





VICTORIAN SCROLL
Lever on Round Rose
Face Fix

Dimensions (mm):

Rose:	58 Dia.
Rose Thickness:	10
Projection:	55
Lever Length:	95

CP
 PB
 SC



DL66

WING
Lever on Round Rose
Face Fix

Dimensions (mm):

Rose:	58 Dia.
Rose Thickness:	10
Projection:	55
Lever Length:	116

CP
 PB
 SC









M32

VICTORIAN
Lever on Round Rose
Face Fix

Dimensions (mm):

Rose:	58 Dia.
Rose Thickness:	10
Projection:	52
Lever Length:	105

CP
 PB
 SC





PLW

PORCELAIN
Lever on Round Rose
Face Fix

Dimensions (mm):

Rose:	58 Dia.
Rose Thickness:	10
Projection:	65
Lever Length:	130

PLW





PLWCP

PORCELAIN
Lever on Round Rose
Face Fix

Dimensions (mm):

Rose:	58 Dia.
Rose Thickness:	10
Projection:	65
Lever Length:	130

PLWCP





AA145/345

ESCUTCHEON
Face Fix

Dimensions (mm):

Rose:	45 Dia.
-------	---------

AA145 Euro
AA345 Lock

DB

PB

SN

CP

SC

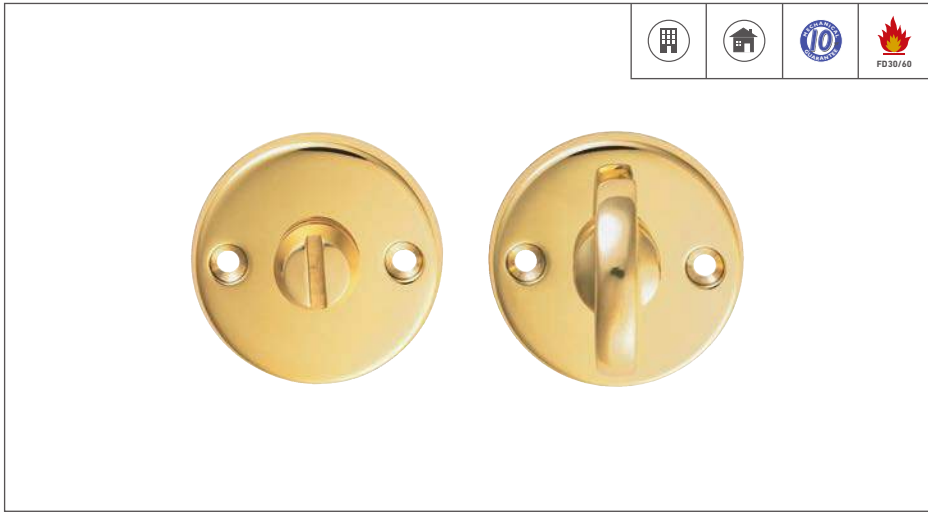

B12

THUMBTURN AND RELEASE
Face Fix

Dimensions (mm):
Rose: 45 Dia.



-  DB
-  PB
-  SN
-  CP
-  SC



Carlisle Brass Traditional Levers on Backplate





DL18

ASHTEAD
Lever on Latch Backplate

Dimensions (mm):
 Backplate: 168x47
 Projection: 57
 Lever Length: 95
 Plate Thickness: 12

Variations:

DL17	Lock
DL17Y	Euro 47.5c/c
DL17U	Oval 48.5c/c
DL18WC	Bathroom

Short Plate: 112x47

DL16 Latch

CP
 PB
 PVD







DL30

VICTORIAN ASCOT
Lever on Lock Backplate - Heavy

Dimensions (mm):
 Backplate: 150x43
 Projection: 52
 Lever Length: 105
 Plate Thickness: 10

Variations:

DL30WC	Bathroom
DL30Y	Euro 47.5c/c
DL30U	Oval 48.5c/c

Short Plate: 118x43

DL31 Latch
DL31WC Privacy

CP
 PB
 SC

DL16 and DL17 not available in PVD finish. DL17U not available in PVD or CP finish.
 DL16/17/18 for matching letterplate DL19 see P164. DL16/17/18 for matching fingerplate DL20 see P146.
 DL30U not available in CP or SC finish. DL30 /31 for matching letterplates see P166.



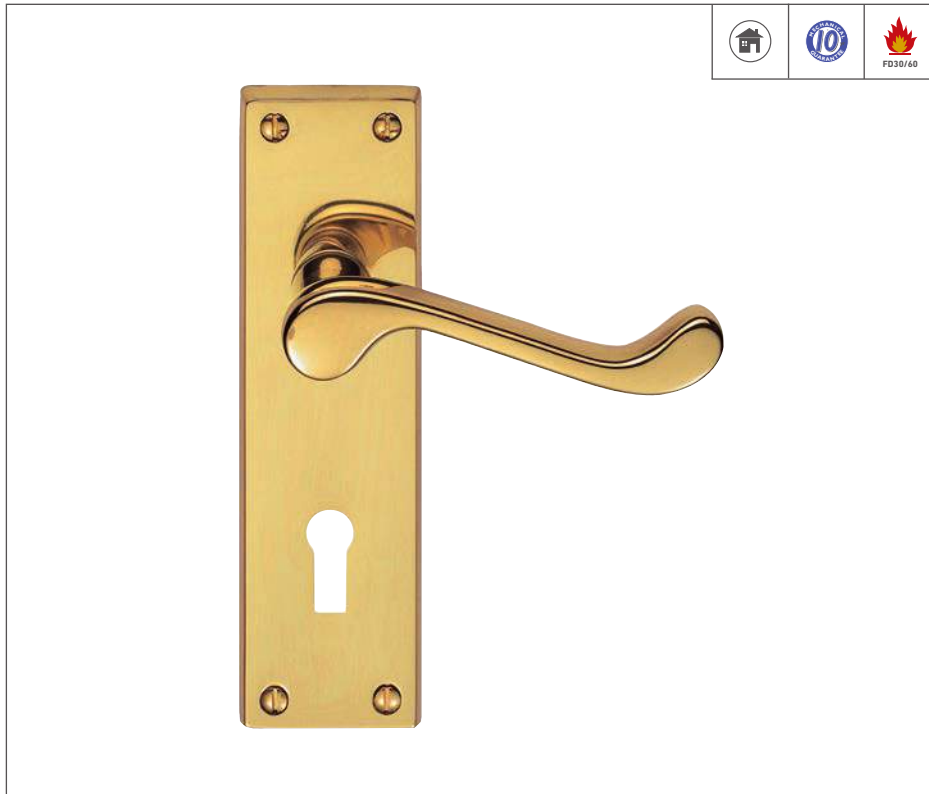

DL54

VICTORIAN SCROLL
Lever on Lock Backplate

Dimensions (mm):
 Backplate: 150x43
 Projection: 55
 Lever Length: 95
 Plate Thickness: 10

Variations:

DL54WC Bathroom
DL54Y Euro 47.5c/c
DL54U Oval 48.5c/c

Short Plate: 118x43

DL55 Latch
DL55WC Privacy



DL64

WING
Lever on Lock Backplate

Dimensions (mm):
 Backplate: 150x43
 Projection: 55
 Lever Length: 116
 Plate Thickness: 10

Variations:

DL64WC Bathroom
DL64Y Euro 47.5c/c

Short Plate: 118x43

DL65 Latch
DL65WC Privacy



DL54/55 also available on rose DL56 see P119. DL64/65 also available on rose DL66 see P119.
 Contract range available contact our sales office on 01228 511030 for details.



DL68



BIRKDALE

Lever on Lock Backplate

Dimensions (mm):

Backplate:	170x45
Projection:	55
Lever Length:	95
Plate Thickness:	10

Variations:

DL67	Latch
DL68WC	Bathroom
DL68U	Oval 48.5c/c



DL75



VICTORIAN CONTEMPORARY

Lever on Lock Backplate

Dimensions (mm):

Backplate:	150x43
Projection:	58
Lever Length:	108
Plate Thickness:	10

Variations:

DL75WC	Bathroom
DL75Y	Euro 47.5c/c

Short Plate: 118x43

DL76	Latch
DL76WC	Privacy



DL67/68 also available on rose DL56 see P119.
DL75/76 for matching letterplate see P166.



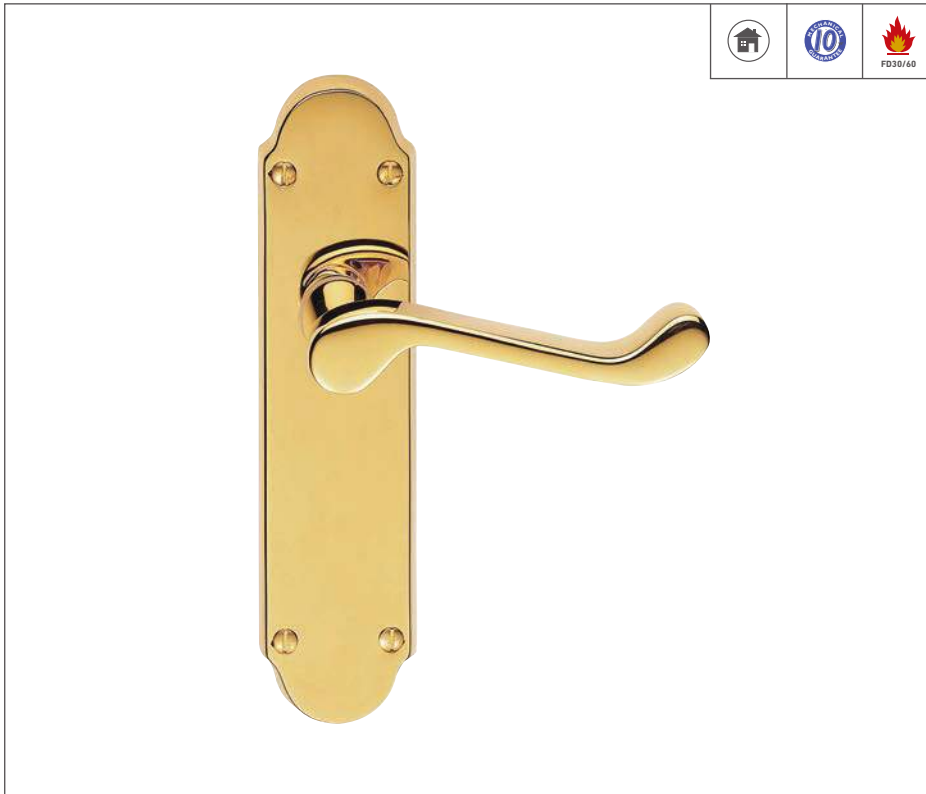

DL167

OAKLEY
Lever on Latch Backplate

Dimensions (mm):
 Backplate: 170x42
 Projection: 55
 Lever Length: 95
 Plate Thickness: 10

Variations:

DL167WC Privacy
DL168 Lock
DL168WC Bathroom
DL168U Oval 48.5c/c
DL168Y Euro 47.5c/c

Short Plate: 115x42

DL166 Latch

CP
 PB

SC
 PVD

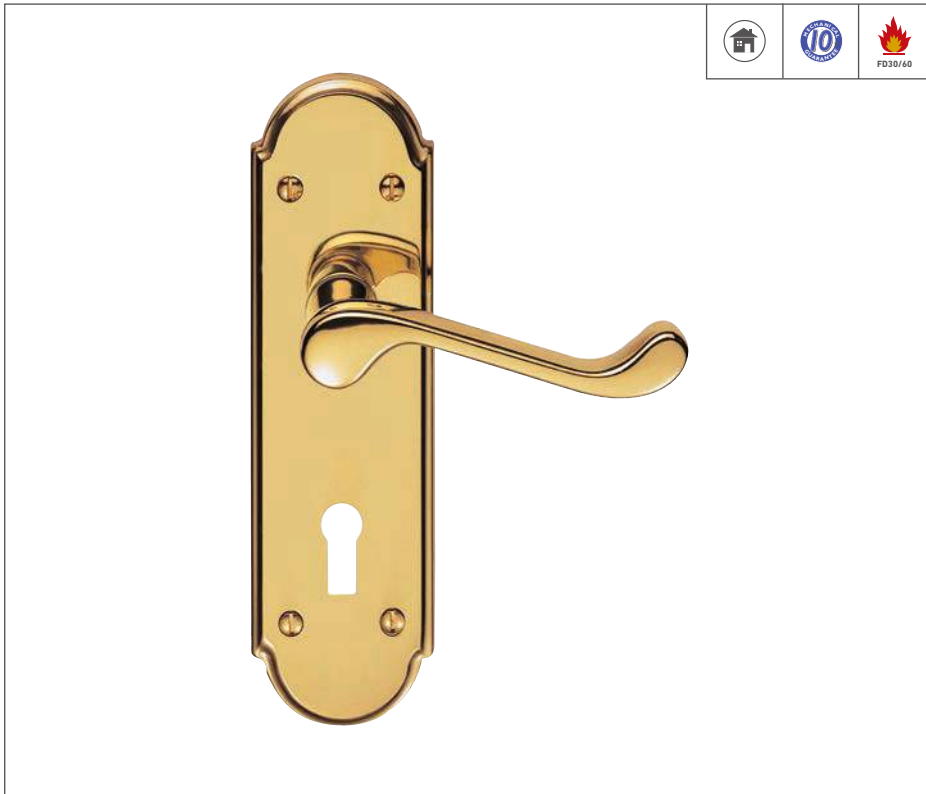

DL301

GARRICK
Lever on Lock Backplate

Dimensions (mm):
 Backplate: 175x50
 Projection: 55
 Lever Length: 95
 Plate Thickness: 10

Variations:

DL300 Latch
DL302 Bathroom

PB



DL167WC not available in PVD finish. DL166 not available in PVD or SC finish.







M30

VICTORIAN
Lever on Lock Backplate



Dimensions (mm):
 Backplate: 150x43
 Projection: 52
 Lever Length: 105
 Plate Thickness: 10

Variations:
M30U Oval 48.5c/c
M30Y Euro 47.5c/c
M30WC Bathroom

Short Plate: 118x43
M31 Latch
M31WC Privacy

CP
 PB
 SC



M63

VICTORIAN M SERIES
Lever on Lock Backplate

Dimensions (mm):
 Backplate: 150x43
 Projection: 61
 Lever Length: 106
 Plate Thickness: 10

Variations:
M63Y Euro 47.5c/c
M63WC Bathroom



Short Plate: 118x43
M64 Latch
M64WC Privacy

CP
 PB
 SC

M30/31 also available in rose M32 see P119. M64WC not available in PB finish.
 Contract range available contact our sales office on 01228 511030 for details.





M68

VICTORIAN SHAPED SCROLL
Lever on Lock Backplate

Dimensions (mm):
 Backplate: 205x49
 Projection: 53
 Lever Length: 95
 Plate Thickness: 8

Variations:



M68WC	Bathroom
M67	Latch
M68Y	Euro 47.5c/c
M68U	Oval 48.5c/c

CP

PB

SC



DL100

ST JAMES
Lever on Lock Backplate

Dimensions (mm):
 Backplate: 155x51
 Projection: 54
 Lever Length: 109
 Plate Thickness: 11

Variations:

DL102	Latch
DL100WC	Bathroom

PB



M68U not available in CP or SC finish. Contract range available contact our sales office on 01228 511030 for details.



DL271

CHESHAM

Lever on Lock Backplate

Dimensions (mm):

Backplate:	249x50
Projection:	51
Lever Length:	109
Plate Thickness:	8

Variations:

DL270	Latch
DL272	Bathroom
DL271Y	Euro 47.5c/c

Short Plate: 175x50

DL265	Latch
DL266	Lock
DL266Y	Euro 47.5c/c
DL267	Bathroom

Mini Plate: 110x50

DL263 Latch



FG1

GEORGIAN

Lever on Lock Backplate

Dimensions (mm):

Backplate:	150x48
Projection:	62
Lever Length:	102
Plate Thickness:	10

Variations:

FG1Y	Euro 47.5c/c
FG1WC	Bathroom

Short Plate: 112x48

FG2	Latch
FG2WC	Privacy



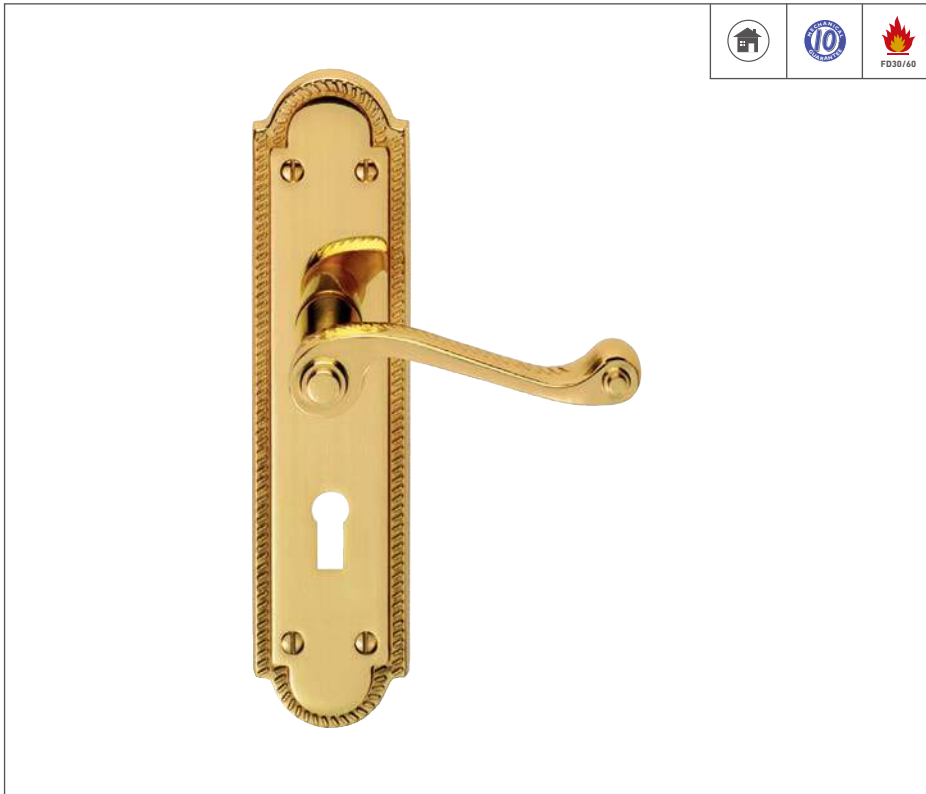

FG27

GEORGIAN SHAPED
Lever on Lock Backplate

Dimensions (mm):
 Backplate: 205x49
 Projection: 61
 Lever Length: 102
 Plate Thickness: 9

Variations:
FG26L Latch
FG27Y Euro 47.5c/c
FG27WC Bathroom

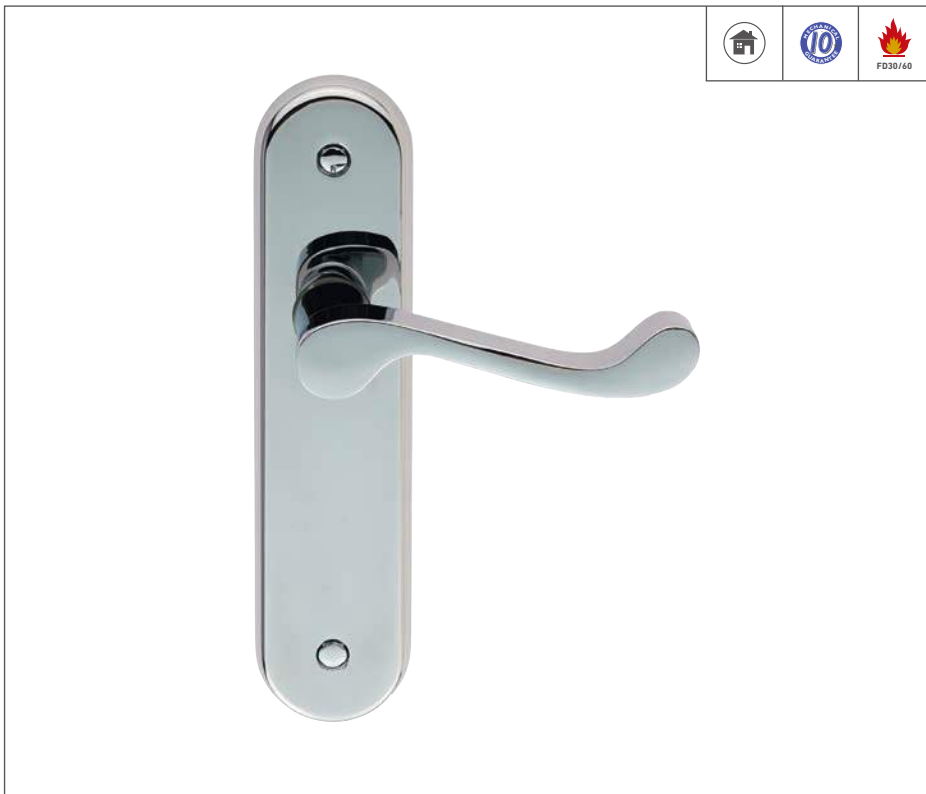

DL161



SAVANNAH
Lever on Latch Backplate

Dimensions (mm):
 Backplate: 172x40
 Projection: 54
 Lever Length: 94
 Plate Thickness: 10

Variations:
DL160 Lock
DL160Y Euro 47.5c/c
DL162 Bathroom
Long Plate: 238x35
DL460 Lock
DL461 Latch
DL462 Bathroom





DL181

ANDROS
Lever on Latch Backplate



Dimensions (mm):
 Backplate: 180x40
 Projection: 58
 Lever Length: 115
 Plate Thickness: 10

Variations:

DL180 Lock
DL180Y Euro 47.5c/c
DL182 Bathroom
Long Plate: 241x40
DL380 Lock
DL381 Latch
DL382 Bathroom
DL380Y Euro 47.5c/c

CP
 PB
 SC



DL191

MADRID
Lever on Latch Backplate

Dimensions (mm):
 Backplate: 180x45
 Projection: 57
 Lever Length: 112
 Plate Thickness: 10

Variations:

DL190 Lock
DL192 Bathroom
Long Plate: 245x45
DL290 Lock
DL291 Latch
DL292 Bathroom
DL290Y85 Euro 85c/c

CP
 PB
 SC
 FB
 PVD

DL290Y85 not available in CP, FB, SC or PVD finish. DL290/291/292 not available in FB or SC finish.
 DL190/191/192 not available in PVD finish.



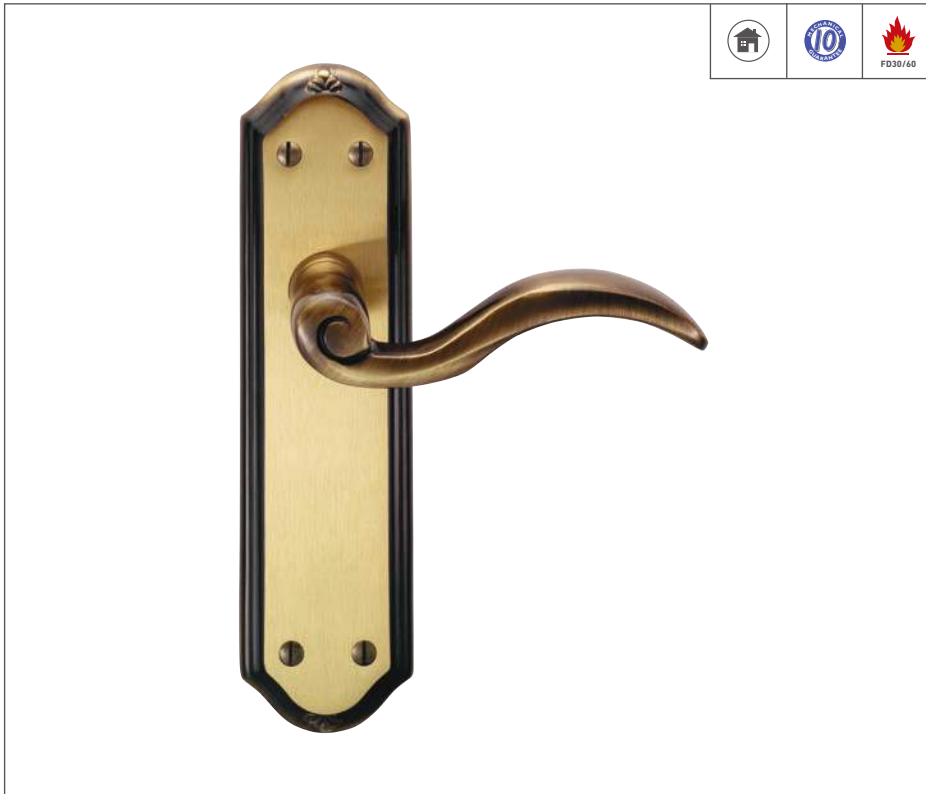

DL341

WENTWORTH
Lever on Latch Backplate

Dimensions (mm):
 Backplate: 180x48
 Projection: 60
 Lever Length: 109
 Plate Thickness: 10

Variations:

DL340	Lock
DL342	Bathroom
Long Plate:	270x48
DL344	Lock
DL345	Latch
DL346	Bathroom

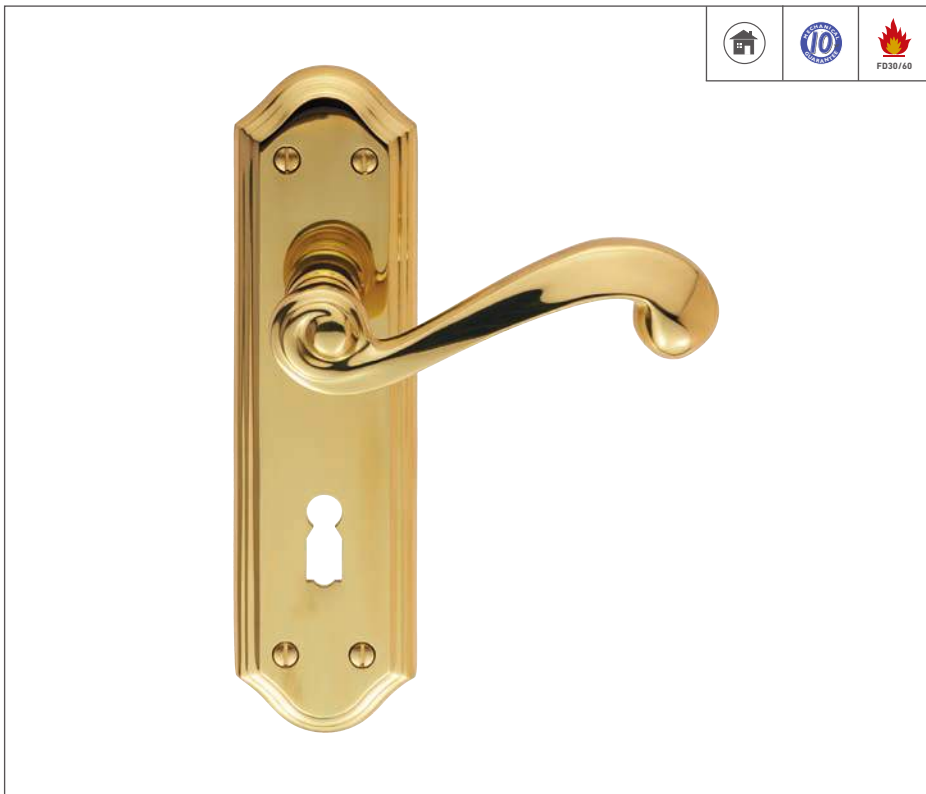

DL350

ST GEORGE
Lever on Lock Backplate

Dimensions (mm):
 Backplate: 180x48
 Projection: 66
 Lever Length: 110
 Plate Thickness: 10

Variations:

DL351	Latch
DL352	Bathroom





DL411



EDEN
Lever on Latch Backplate

Dimensions (mm):
 Backplate: 180x42
 Projection: 72
 Lever Length: 108
 Plate Thickness: 11

Variations:
DL410 Lock
DL412 Bathroom

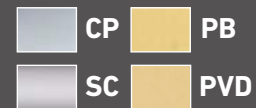

DL451



LYTHAM
Lever on Latch Backplate

Dimensions (mm):
 Backplate: 180x48
 Projection: 65
 Lever Length: 120
 Plate Thickness: 10

Variations:
DL450 Lock
DL452 Bathroom



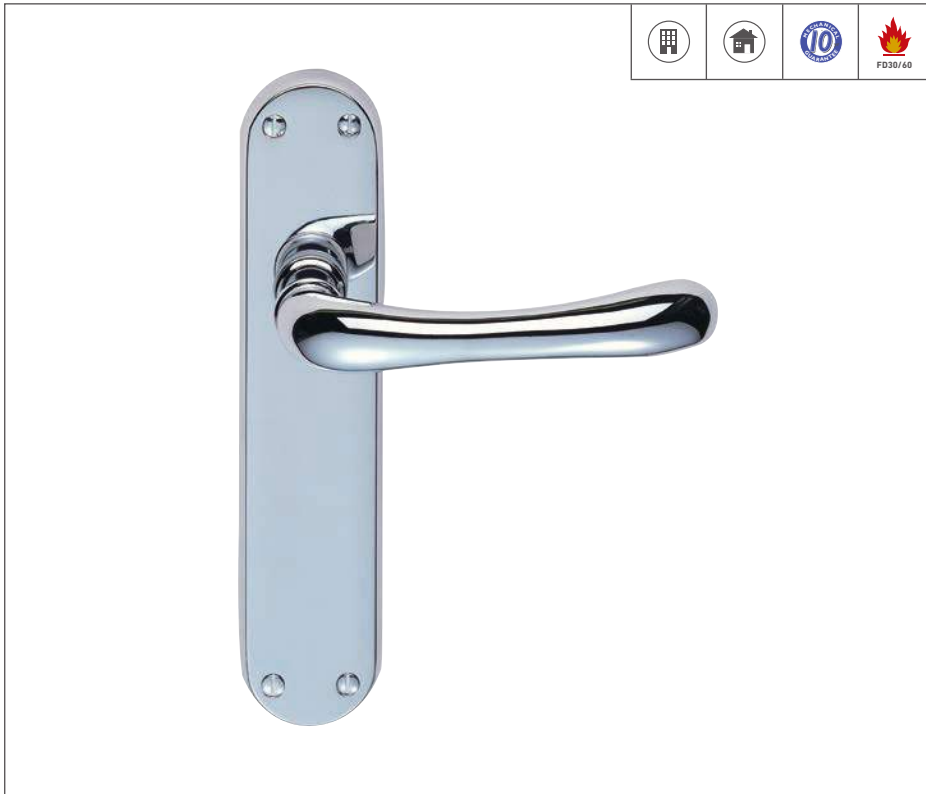

EL12

IBRA
Lever on Latch Backplate

Dimensions (mm):

Backplate: 185x40
 Projection: 69
 Lever Length: 119
 Plate Thickness: 11

Variations:

EL11 Lock
EL11U Oval 48.5c/c
EL11Y Euro 47.5c/c
EL13 Bathroom

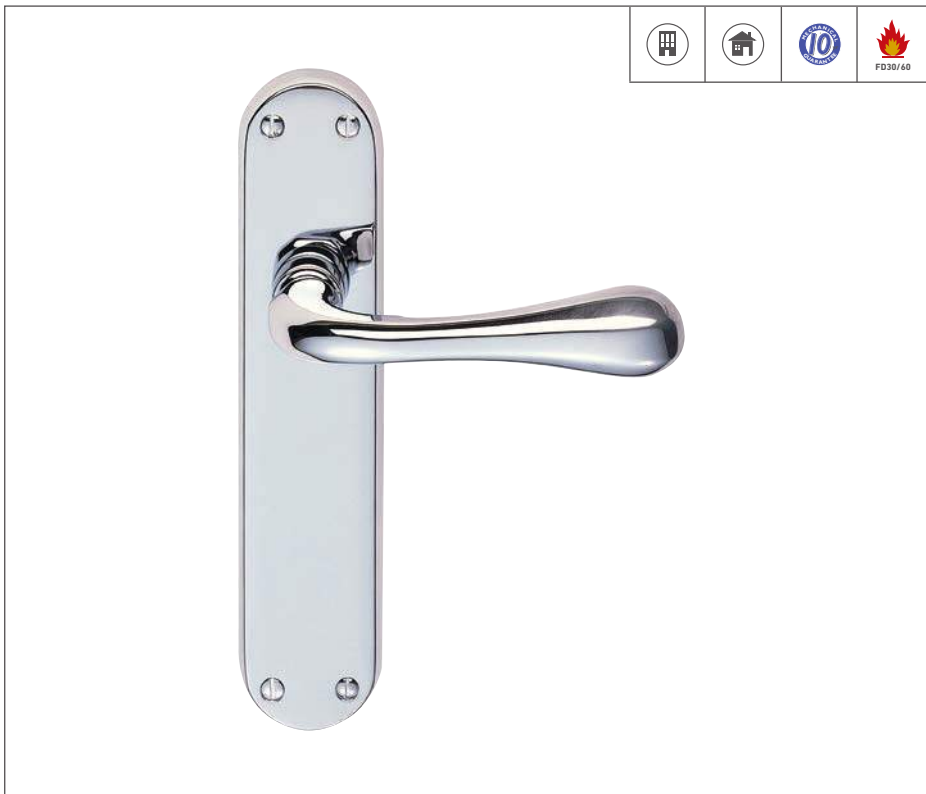

EL22

ASTRO
Lever on Latch Backplate

Dimensions (mm):





Backplate: 185x40
 Projection: 71
 Lever Length: 108
 Plate Thickness: 11

Variations:

EL21 Lock
EL23 Bathroom
EL21Y Euro 47.5c/c





EL32

LILLA
Lever on Latch Backplate

Dimensions (mm):
 Backplate: 185x40
 Projection: 64
 Lever Length: 118
 Plate Thickness: 11

Variations:





EL31	Lock
EL31Y	Euro 47.5c/c
EL33	Bathroom

CP

PB

SC



EL42

IRIS
Lever on Latch Backplate

Dimensions (mm):
 Backplate: 185x40
 Projection: 62
 Lever Length: 119
 Plate Thickness: 11

Variations:

EL41	Lock
EL41Y	Euro 47.5c/c
EL43	Bathroom

CP

PB

SC

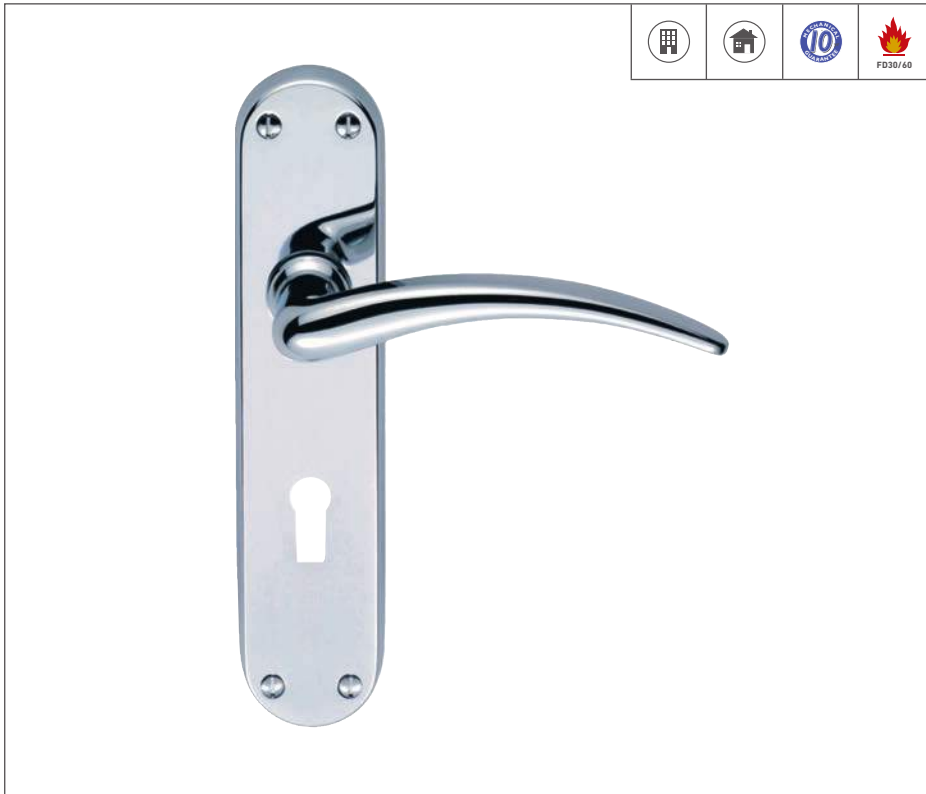

EL60

WING

Lever on Lock Backplate

Dimensions (mm):

Backplate: 185x40
 Projection: 55
 Lever Length: 116
 Plate Thickness: 11

Variations:

EL60Y Euro 47.5c/c
EL61 Latch
EL62 Bathroom

CP PB SC



EL60Y not available in SC finish. EL60-62 also available on rose DL66 see P119.

Carlisle Brass Pull Handles and Push Plates



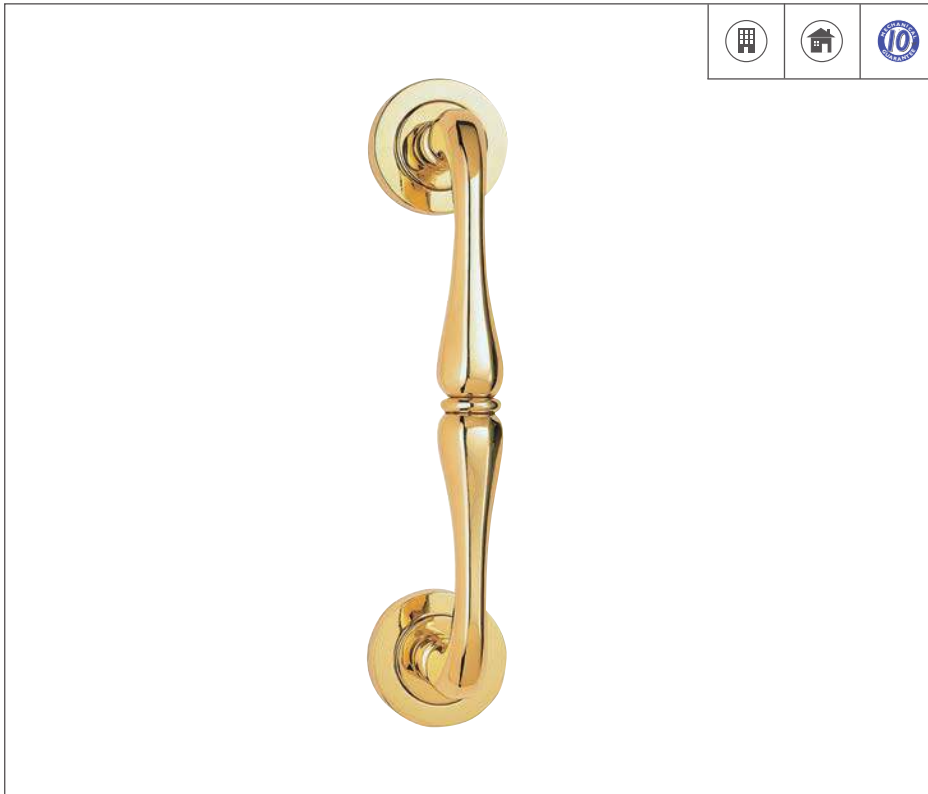

AA15

STELLA
Concealed Fix
Pull Handle on Rose

Dimensions (mm):
Rose: 51 Dia.
Centres: 193c/c

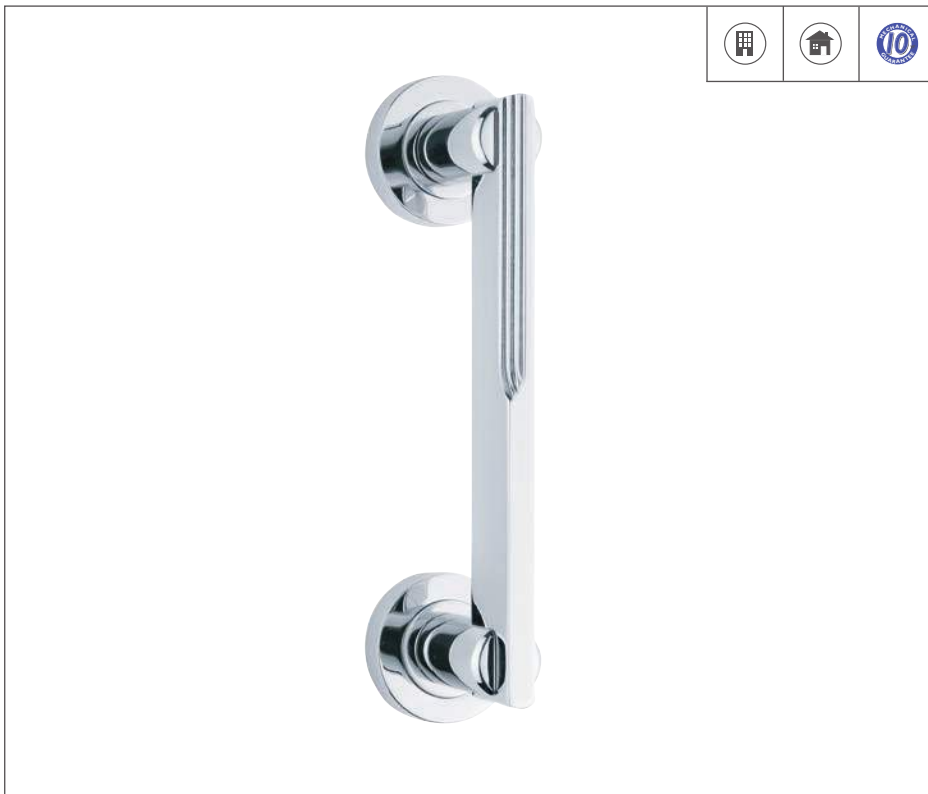

AA19

VERONICA
Concealed Fix
Pull Handle on Rose

Dimensions (mm):
Rose: 51 Dia.
Centres: 170c/c



AA15 for matching lever AQ1 see P45.
AA19 for matching lever AQ5 see P46.



AA36

BOW HANDLE

Variations:

AA36	152c/c
AA36L	178c/c



AA90

CRANKED PULL HANDLE

Variations:

AA90	227c/c
AA91	306c/c



AA36L not available in CP or SC finish.





🏢
🏠
10

AA92

PUB STYLE
Face Fix
Pull Handle on Rose

Variations:

AA92	Length 249
AA93	Length 300

CP

PB

SC



🏢
🏠
10

AA95

CAST PULL HANDLE

Dimensions (mm):

AA95	294x59
-------------	--------

CP



DL611

CHESHAM PULL HANDLE

Dimensions (mm):

DL611 298x57



PF108

REEDED GRIP

Bolt Through
Pull Handle on Rose

Dimensions (mm):

Overall Length: 494
Centres: 354c/c



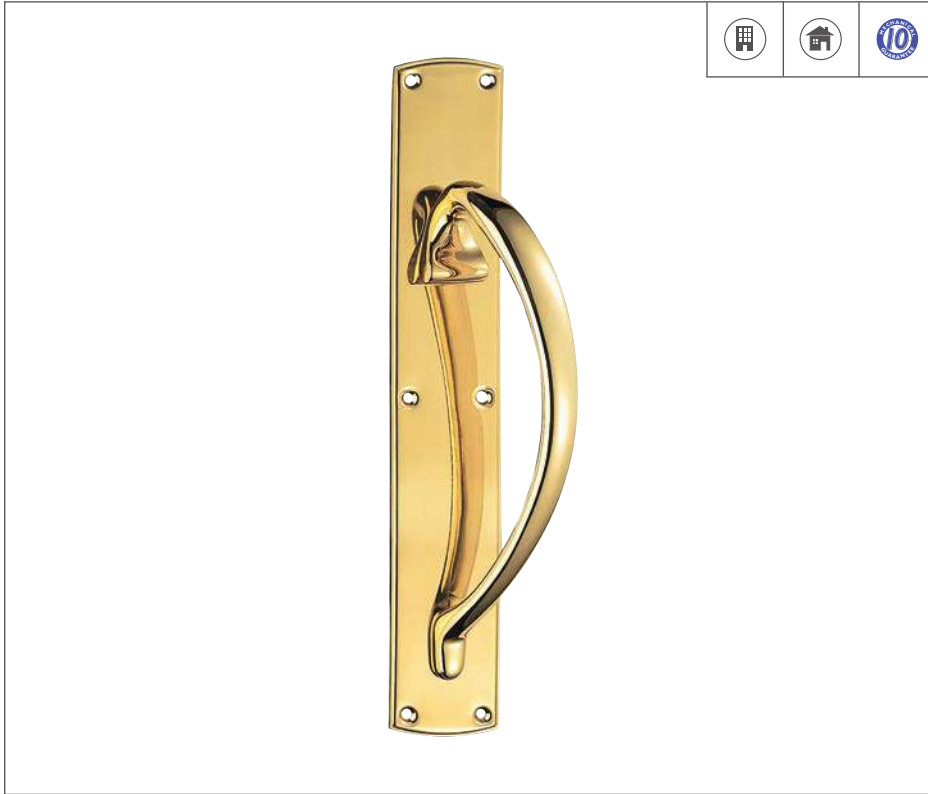

PF100R/L

LARGE PULL HANDLE

Variations:

- PF100R** Right Hand 457x76
- PF101L** Left Hand 457x76



PF102

LARGE PUSH PLATE

Dimensions (mm):

- PF102** 457x76





PF103ER/L

ENGRAVED LARGE PULL HANDLE
Right Hand

Variations:

PF103ER 457x76
PF104EL Left Hand 457x76

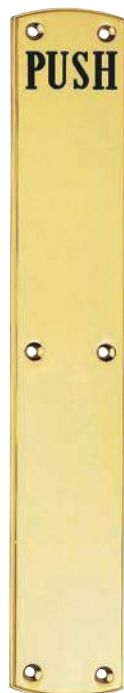







PF105E

ENGRAVED LARGE PUSH PLATE

Dimensions (mm):

PF105E 457x76



	  	PF106
		ORNATE PULL HANDLE Dimensions (mm): PF106 380x65
		 CP  PB

	  	PF107
		FINGER PLATE Dimensions (mm): PF107 380x65
		 CP  PB



PF109AR/L

LAURIN PULL HANDLE

Right Hand

Variations:

PF109AR Right Hand 376x42

PF109AL Left Hand 376x42



PF110





LAURIN FINGER PLATE

Dimensions (mm):





PF110 369x64







	  	DL20
		SHAPED END FINGER PLATE Dimensions (mm): DL20 300x64
		 PB

	  	FG10
		FINGER PLATE Dimensions (mm): FG10 304x73
		 PB

	  	M39
		FINGER PLATE Dimensions (mm): M39 298x73
		 CP  PB  SC



	  	M39F
		FLAT SHEET FINGER PLATE Dimensions (mm): M39F 305x77
		 PB

	  	M1002
	QUEEN ANNE FINGER PLATE Dimensions (mm): M1002 305x70	
		 PB

Carlisle Brass Mortice Knobs





AC050

LARGE MORTICE KNOB
Unsprung

Dimensions (mm):
 Rose: 65 Dia.
 Knob: 69 Dia.
 Projection: 77

CP

PB

FB

SC







AQ34

OVAL MORTICE KNOB
Solid Unsprung

Dimensions (mm):
 Rose: 62 Dia.
 Knob: 62x40
 Projection: 80

CP

PB



AC050 for matching escutcheons DK1/3 see P156. AC050 for matching bathroom turns DK12/13 see P157.
 AQ34 for matching escutcheon AQ41 see P180. DL56/66 for matching bathroom turn AQ133 see P156.







AQ35



MUSHROOM MORTICE KNOB
Solid Unsprung

Dimensions (mm):
 Rose: 62 Dia.
 Knob: 52 Dia.
 Projection: 73

CP

PB



FG4

GEORGIAN MORTICE KNOB
Half Sprung



Dimensions (mm):
 Rose: 60 Dia.
 Knob: 53 Dia.
 Projection: 66

PB

AQ35 for matching escutcheon AQ41 see P180. AQ35 for matching bathroom turn AQ133 see P156.





M34

OVAL MORTICE KNOB
Half Sprung

Dimensions (mm):
 Rose: 61 Dia.
 Knob: 55x38
 Projection: 72

CP



PB

SN

DB

SC



M48

BALL MORTICE KNOB
Solid Half Sprung

Dimensions (mm):
 Rose: 61 Dia.
 Knob: 45 Dia.
 Projection: 86

CP

PB

SN

DB

SC



For matching escutcheons AA145/345 see P120. For matching bathroom turn B12 see P121.
 M48 for matching escutcheons AA145/345 see P120. M48 for matching bathroom turn B12 see P121.



M1001

QUEEN ANNE MORTICE KNOB
Unsprung

Dimensions (mm):

Rose: 61 Dia.
Knob: 52 Dia.
Projection: 74

Rim Knob Variations:

M1001R

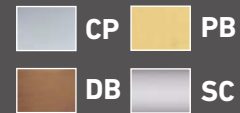

M35

MUSHROOM MORTICE KNOB
Half Sprung

Dimensions (mm):



Rose: 61 Dia.
Knob: 52 Dia.
Projection: 71



M1001 for matching escutcheon M1000 see P156. M1001 for matching bathroom turn AQ133 see P156.
M1001 for matching fingerplate M1002 see P148. M1001 for matching cupboard knobs M1003-5 see P469.





M35C

MUSHROOM MORTICE KNOB
Concealed Fix Unsprung

Dimensions (mm):
 Rose: 65 Dia.
 Knob: 58 Dia.
 Projection: 71



CP

PB

DB

SC



M35US

MUSHROOM MORTICE KNOB
Unsprung

Dimensions (mm):
 Rose: 56 Dia.
 Knob: 53 Dia.
 Projection: 69

Variations: **M35USB**
 Rose: 65 Dia.
 Knob: 53 Dia.
 Projection: 66

CP

PB



DB

SC

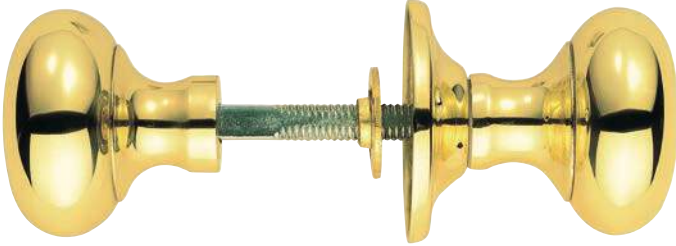

For matching escutcheons AA145/345 see P120. For matching bathroom turn B12 see P121.



M35RS



MUSHROOM RIM KNOB
Unsprung

Dimensions (mm):
 Rose: 56 Dia.
 Knob: 53 Dia.
 Projection: 69

Variations: **M35RB**
 Rose: 65 Dia.
 Knob: 53 Dia.
 Projection: 66

CP
 PB
 SC



AA145/345



ESCUTCHEON
Face Fix

Dimensions (mm):
 Rose: 45 Dia.
 Rose Thickness: 8

AA145 Euro
AA345 Lock

CP
 PB
 SN
 DB
 SC



AQ41

ESCUTCHEON
Face Fix

Dimensions (mm):
 Rose: 42 Dia.
 Rose Thickness: 4

CP
 PB
 SC
 FB
 PVD









DK1/3



ESCUTCHEON
Face Fix

Dimensions (mm):
Rose: 55 Dia.
Rose Thickness: 10

DK1 Euro
DK3 Lock

CP
 PB
 SN
 FB
 SC









M1000

QUEEN ANNE COVERED ESCUTCHEON

Dimensions (mm):
Rose: 31 Dia.
Rose Thickness: 7

CP
 PB
 FB
 SC



AQ133

OVAL THUMBTURN AND RELEASE
Face Fix



Dimensions (mm):
Rose: 42 Dia.
Rose Thickness: 5

CP
 PB



AQ133 extension piece SP85 available for 40-54mm doors.



B12

THUMBTURN AND RELEASE
Face Fix

Dimensions (mm):
Rose: 45 Dia.
Rose Thickness: 8

CP



PB

SN

DB

SC



DK12

LARGE THUMBTURN AND RELEASE
Face Fix

Dimensions (mm):
Rose: 55 Dia.
Rose Thickness: 10



CP

PB

FB

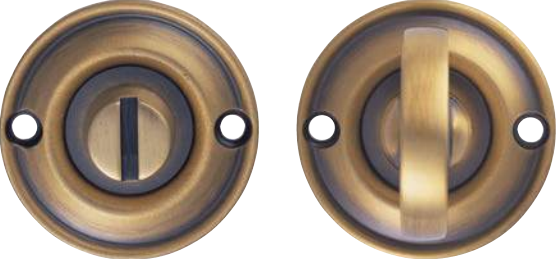
SC



DK13

SMALL THUMBTURN AND RELEASE
Face Fix

Dimensions (mm):
Rose: 42 Dia.
Rose Thickness: 4

CP

PB



FB

SC

Carlisle Brass External Door Furniture





AQ1NP

STELLA NARROW PLATE

Dimensions (mm):

Backplate:	208x26
Projection:	74
Lever Length:	110
Lock Centres:	70
Fixing Centres:	180
Plate Thickness:	10

Variations:



AQ1NP92 Lock 92c/c
Fixing 124c/c

CP

PB

SC



AQ2NP

STUDIO H NARROW PLATE

Dimensions (mm):

Backplate:	208x26
Projection:	65
Lever Length:	120
Lock Centres:	70
Fixing Centres:	180
Plate Thickness:	10

Variations:

AQ2NP92 Lock 92c/c
Fixing 124c/c



CP

SC

AQ1NP for matching lever AQ1 see P45.
AQ2NP for matching lever AQ2 see P45.





M86NP92

STRAIGHT NARROW PLATE

Dimensions (mm):
 Backplate: 208x26
 Projection: 61
 Lever Length: 118
 Lock Centres: 92
 Fixing Centres: 124
 Plate Thickness: 10



Variations:
M86NP Lock 70c/c
 Fixing 180c/c

CP

PB

SC



M140NP92RH

SCROLL NARROW PLATE

Dimensions (mm):
 Backplate: 208x26
 Projection: 69
 Lever Length: 123
 Lock Centres: 92
 Fixing Centres: 124
 Plate Thickness: 10

Variations:
M140NP92LH Left Hand
M140NPRH Right Hand
 Lock 70c/c Fixing 180c/c
M140NPLH Left Hand
 Lock 70c/c Fixing 180c/c

BL

PB

CP

SC



SZS01NP92



ROSA NARROW PLATE

Dimensions (mm):

Backplate:	220x26
Projection:	73
Lever Length:	112
Lock Centres:	92
Fixing Centres:	124
Plate Thickness:	10



SZS03NP92RH



VERDE NARROW PLATE

Dimensions (mm):

Backplate:	220x26
Projection:	69
Lever Length:	113
Lock Centres:	92
Fixing Centres:	124
Plate Thickness:	10

Variations:

SZS03NP92LH	Left Hand Lock 92c/c Fixing 124c/c
--------------------	------------------------------------------









SZS12NP92RH

AMARILLO NARROW PLATE

Dimensions (mm):

Backplate:	220x26
Projection:	55
Lever Length:	117
Lock Centres:	92
Fixing Centres:	124
Plate Thickness:	10

Variations:

SZS12NP92LH Left Hand

CP

SC









ML050121-27

PRO SECURE NARROW PLATE

Dimensions (mm):

Backplate:	220x35
Projection:	72
Lever Length:	126
Lock Centres:	92
Fixing Centres:	122
Plate Thickness:	16

Long Plate Variations:

ML050201-208 240x35

Lever Pad Variations:

ML050231 240x35

PC

PG

PCB

SC



M86NP not available in CP finish.
 M140NPLH and M140NPRH not available in CP finish.
 ML050121-231 Pro Secure Narrow Plate contact our sales office on 01228 511030 for product finish details.

Carlisle Brass External Door Furniture





AA52

LETTER TIDY
Curved Pattern

Variations:

AA52	301x96
AA53	281x79
AA54	Foam Lined 281x79
AA56	355x126



DL19

ASHTED LETTER PLATE
Gravity Flap



Dimensions (mm):

Outer Frame:	279x77
Aperture:	215x42
Fixing Centres:	252

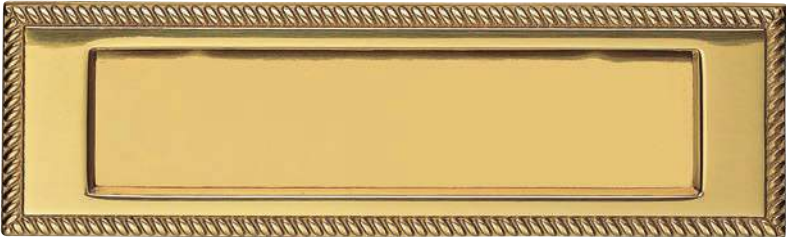

AA52 not available in FB or SC finish. AA53 not available in SC finish. AA54 not available in FB or SC finish. AA56 not available in FB or SS finish.



FG7

GEORGIAN LETTER PLATE



Variations:

FG7B
 Outer Frame: 279x89
 Aperture: 204x47
 Fixing Centres: 233

FG7S
 Outer Frame: 254x76
 Aperture: 191x44
 Fixing Centres: 226

 **PB**



M36G

PLAIN LETTER PLATE
Gravity Flap

Dimensions (mm):
 Outer Frame: 270x72
 Aperture: 202x46
 Fixing Centres: 252

 **CP**
 **PB**
 **SC**



M36S

PLAIN LETTER PLATE

Variations:

M36A (Contract)

Outer Frame: 254x78
 Aperture: 194x41
 Fixing Centres: 224

M36B

Outer Frame: 278x96
 Aperture: 210x53
 Fixing Centres: 242

M36D

Outer Frame: 306x104
 Aperture: 249x61
 Fixing Centres: 275

M36E

Outer Frame: 359x113
 Aperture: 284x63
 Fixing Centres: 327

M36F

Outer Frame: 401x124
 Aperture: 319x71
 Fixing Centres: 361

M36H

Outer Frame: 282x80
 Aperture: 229x51
 Fixing Centres: 259

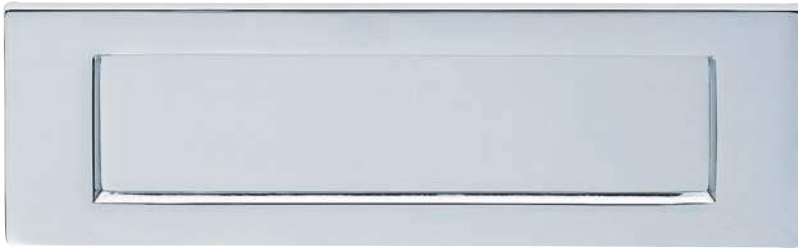

M36S

Outer Frame: 257x81
 Aperture: 185x40
 Fixing Centres: 220





M36A not available in CP, FB, PVD or SC finish. M36B,D,E and F not available in FB or PVD finish.
 M36H not available in FB finish.



 
M78

POSTAL KNOCKER

Dimensions (mm):
 Outer Frame: 256x80
 Aperture: 195x45
 Fixing Centres: 226



 CP
 PB





 
ML110921/22/24/28

PRO STYLE LETTERBOX
 To suit doors 40-80mm thick

Dimensions (mm):
 Overall: 309x76
 Aperture: 258x41

 CP
 PG
 W



SL2

SLEEVE LETTER PLATE
To suit doors 35-65mm thick

Dimensions (mm):
Overall: 300x69
Aperture: 252x36

Finishes:



SL1	SAA
SL2	GAA
SL3	PCW

GAA

PCW

SAA



AC055

LARGE CENTRE DOOR KNOB

Dimensions (mm):
Rose: 90 Dia.
Knob: 100 Dia.
Projection: 95



CP

PB

SC

FB



DL219

CENTRE DOOR KNOB

Dimensions (mm):

Rose:	79
Knob:	69
Projection:	75

PVD







FG15

GEORGIAN CENTRE DOOR KNOB

Dimensions (mm):

Rose:	75 Dia.
Knob:	62 Dia.
Projection:	79

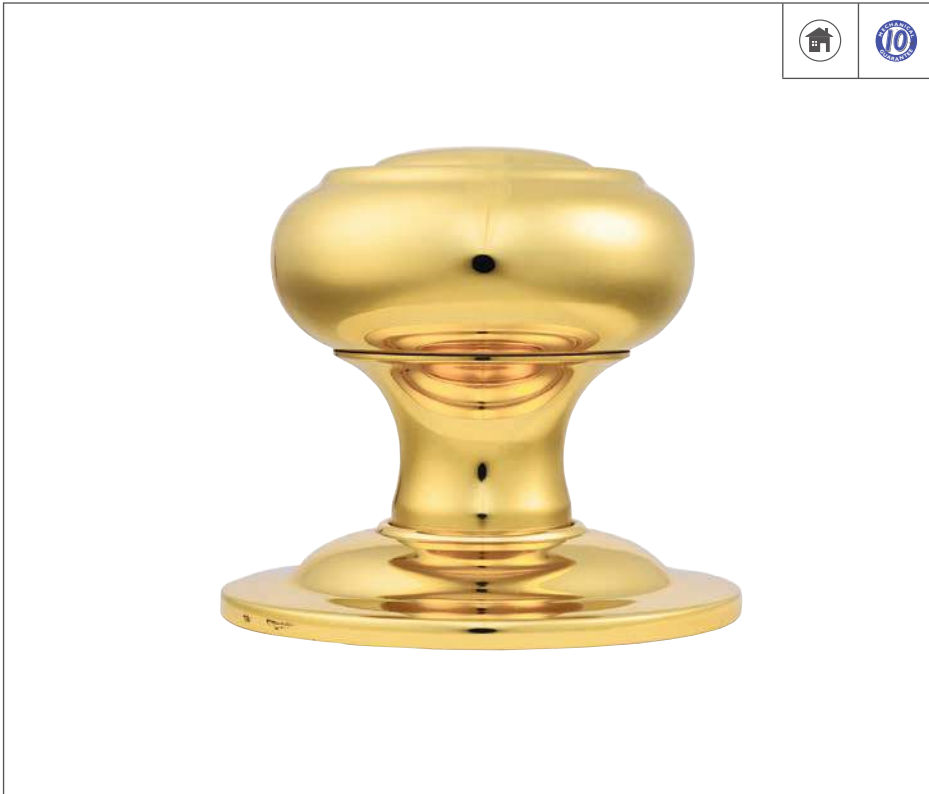
PB



M51

CENTRE DOOR KNOB

Dimensions (mm):
 Rose: 86 Dia.
 Knob: 70 Dia.
 Projection: 75

CP PB SC





M60

ROUND CENTRE DOOR KNOB

Dimensions (mm):
 Rose: 81 Dia.
 Knob: 68 Dia.
 Projection: 80

CP PB SC



M61

ROUND CENTRE DOOR KNOB

Dimensions (mm):

Rose:	86
Knob:	71
Projection:	79

CP

PB

FB

SC





M219

OCTAGONAL CENTRE DOOR KNOB

Dimensions (mm):

Rose:	79 Dia.
Knob:	64 Dia.
Projection:	75

CP

PVD

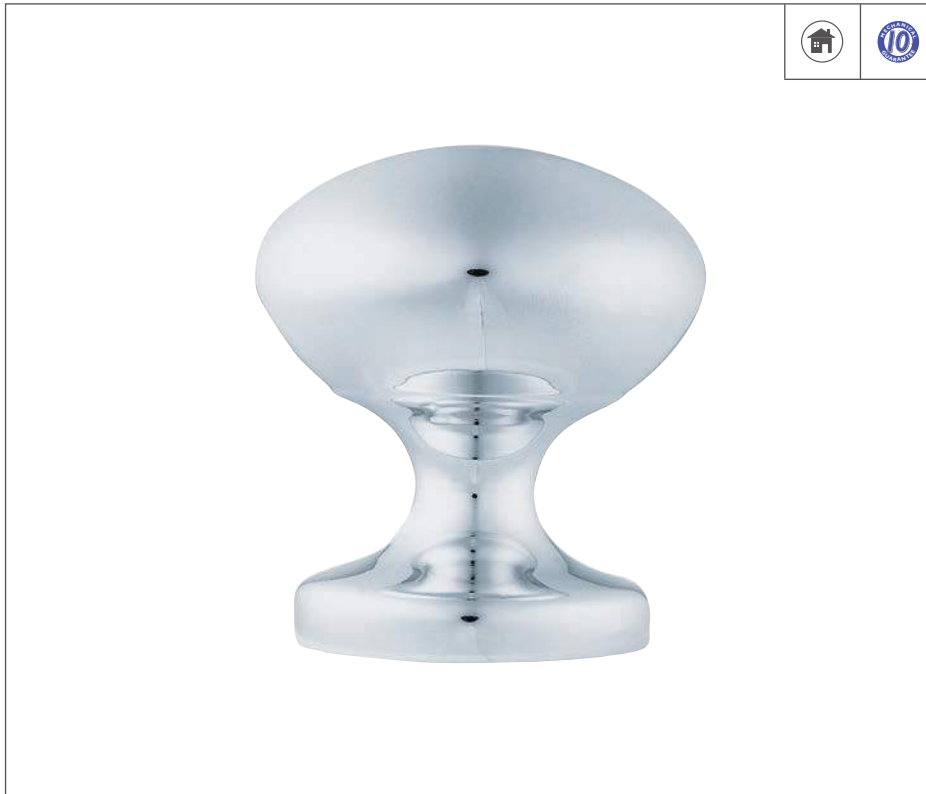

M220

EASY CENTRE DOOR KNOB

Dimensions (mm):

Rose: 55 Dia.
Knob: 70 Dia.
Projection: 80

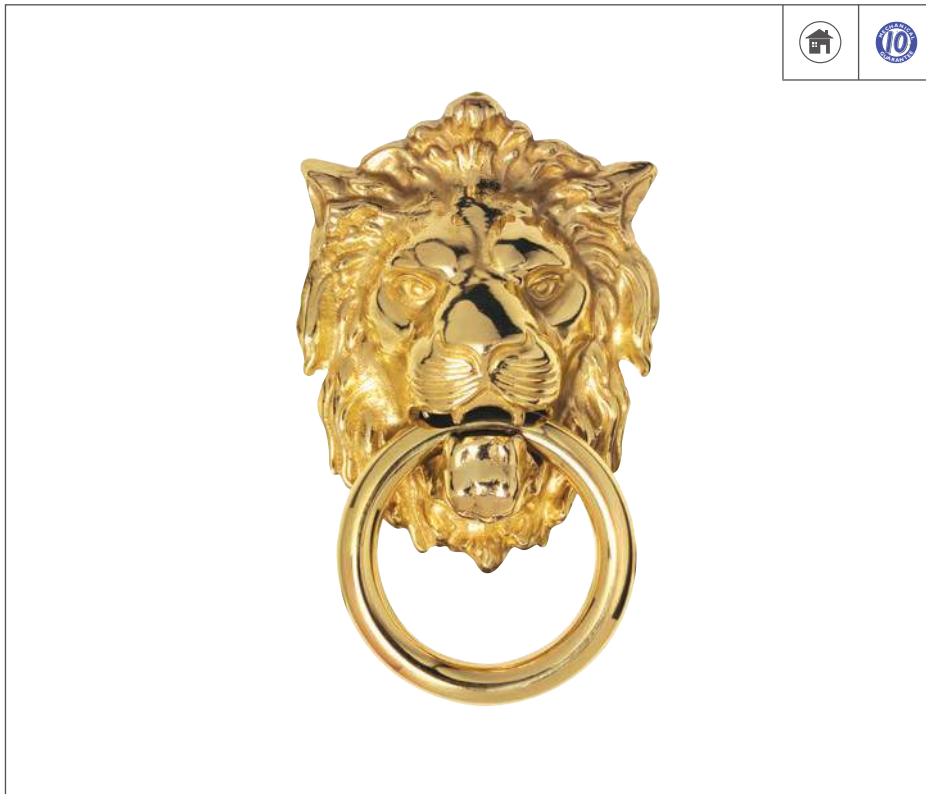

FG8C





LION HEAD DOOR KNOCKER





Complete with strike plate

Dimensions (mm):

Overall: 222x138
Centres: 141



	 	FG8XL
	LARGE LION HEAD DOOR KNOCKER	
Dimensions (mm):		
Backplate:	216x198	
Knocker:	229x210	
Centres:	190	
 PB		

	 	FG11B
	GEORGIAN URN DOOR KNOCKER	
Dimensions (mm):		
Overall:	196x99	
Centres:	124	
 PB		

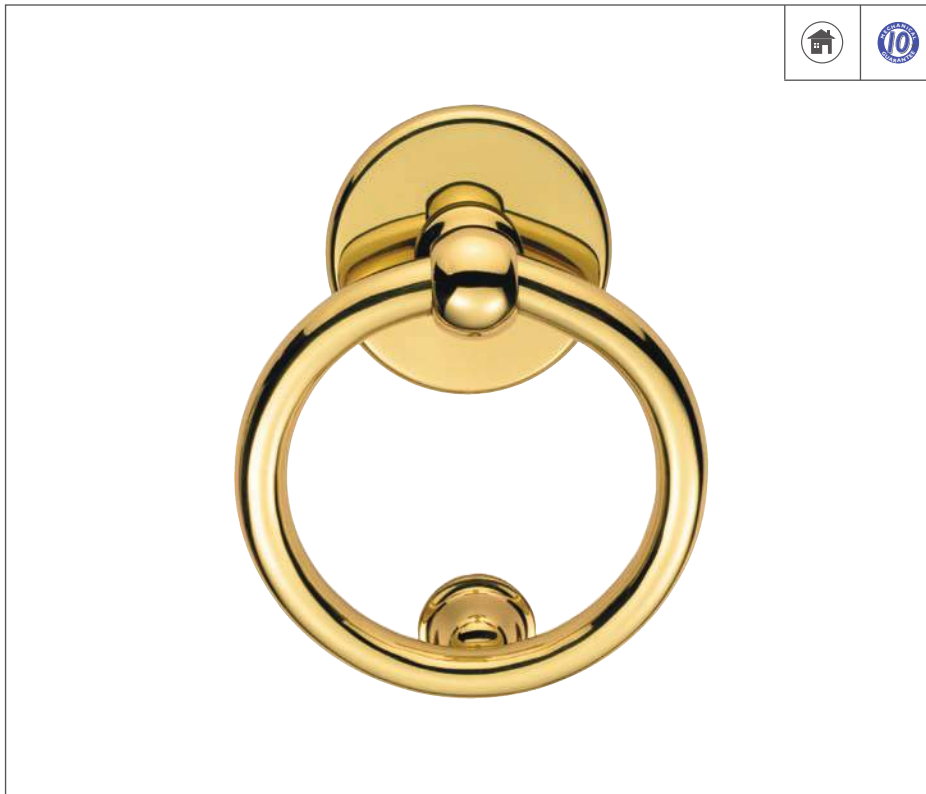

M37

RING DOOR KNOCKER

Dimensions (mm):
 Ring: 127 Dia.
 Fixing Plate: 79 Dia.
 Strike Plate: 35 Dia.

CP PB SC



M38

VICTORIAN URN DOOR KNOCKER

Variations:

M38B
 Overall: 196x99
 Centres: 126



M38S
 Overall: 160x77
 Centres: 95

CP PVD
 PB SC



M38B not available in SC finish.
 M38S not available in PVD finish.



M43

DOOR KNOCKER ON ROSE

Dimensions (mm):

Overall Length:	137
Centres:	95
Rose:	42 Dia.

CP

PB

SC





M45

DOCTOR KNOCKER

Dimensions (mm):

Overall:	187x33
Centres:	121
Rose:	55 Dia.

CP

PVD

FB

SC



M46

**DOOR KNOCKER
ON BACKPLATE**

Dimensions (mm):
 Overall: 136x40
 Centres: 95



CP

PB

SC

FB









MB10

**LION HEAD NO. 10
DOOR KNOCKER**
 Complete with strike plate

Dimensions (mm):
 Overall: 232x119
 Centres: 125

PB



N3

NUMERAL 3

Dimensions (mm):
Height: 75

Variations:

N0	Numeral 0
N1	Numeral 1
N2	Numeral 2
N3	Numeral 3
N4	Numeral 4
N5	Numeral 5
N6/9	Numeral 6/9
N7	Numeral 7
N8	Numeral 8

 **CP**



 **PB**

 **SC**

 **FB**

 **PVD**



NA

LETTER A

Dimensions (mm):
Height: 53

Variations:



NB	Letter B
NC	Letter C
ND	Letter D

 **CP**

 **PB**

 **SC**









AA30

GEORGIAN BELL PUSH

Dimensions (mm):
Overall: 75x37

PB









AA31

BELL PUSH

Dimensions (mm):
Overall: 79x30

CP PB SC







AA75

HEAVY DOOR CHAIN
Breaking strain 180 newtons

Dimensions (mm):
Chain Retainer: 61x15
Chain Overall: 203
Angle Plate: 45x38x32

CP PB SC



AA76

DOOR VIEWER
Suits doors 34-54mm
Plastic Lens

Dimensions (mm):
Lens: 13.7 Dia.
Angle of Vision: 180°

Variations:
AA77 Glass Lens - FD30

CP
 PB
 SC



AQ31

BELL PUSH

Dimensions (mm):
Overall: 74x35

CP
 PB
 SC

FB
 PVD



AQ40

**ARCHITECTURAL QUALITY
CYLINDER PULL**

Dimensions (mm):
Overall: 76x47



CP
 PVD

PB
 SC

AA77 is suitable for use on 30 minute fire doors.





AQ41

ESCUTCHEON
Face Fix

Dimensions (mm):
Rose: 42 Dia.
Rose Thickness: 4

AQ41 Lock

CP



PB

SC

FB

PVD



M40

CYLINDER LATCH PULL



Dimensions (mm):
Overall: 72x48

CP

PB

SC



FG9

GEORGIAN CYLINDER LATCH PULL



Dimensions (mm):
Overall: 76x48

PB



DELAMAIN













AC010

CLEAR CRYSTAL KNOB
Unsprung

Dimensions (mm):
 Rose: 65 Dia.
 Knob: 54 Dia.
 Projection: 86

 CP
 PB
 SC



AC011

FROSTED CRYSTAL KNOB
Unsprung

Dimensions (mm):
 Rose: 65 Dia.
 Knob: 54 Dia.
 Projection: 86

 SC



AC013



BUBBLE CRYSTAL KNOB
Unsprung

Dimensions (mm):

Rose: 65 Dia.
Knob: 54 Dia.
Projection: 87



AC020



FACETTED CRYSTAL KNOB
Unsprung

Dimensions (mm):

Rose: 65 Dia.
Knob: 54 Dia.
Projection: 83



AC010 for matching escutcheons DK1/3 see P156. AC010 for matching bathroom turns DK12/13 see P157.
Unsprung knobs should be used in conjunction with a heavy duty latch.

DELAMAIN



AC033

FROSTED GLASS KNOB
Unsprung

Dimensions (mm):
Rose: 65 Dia.
Knob: 65 Dia.
Projection: 82

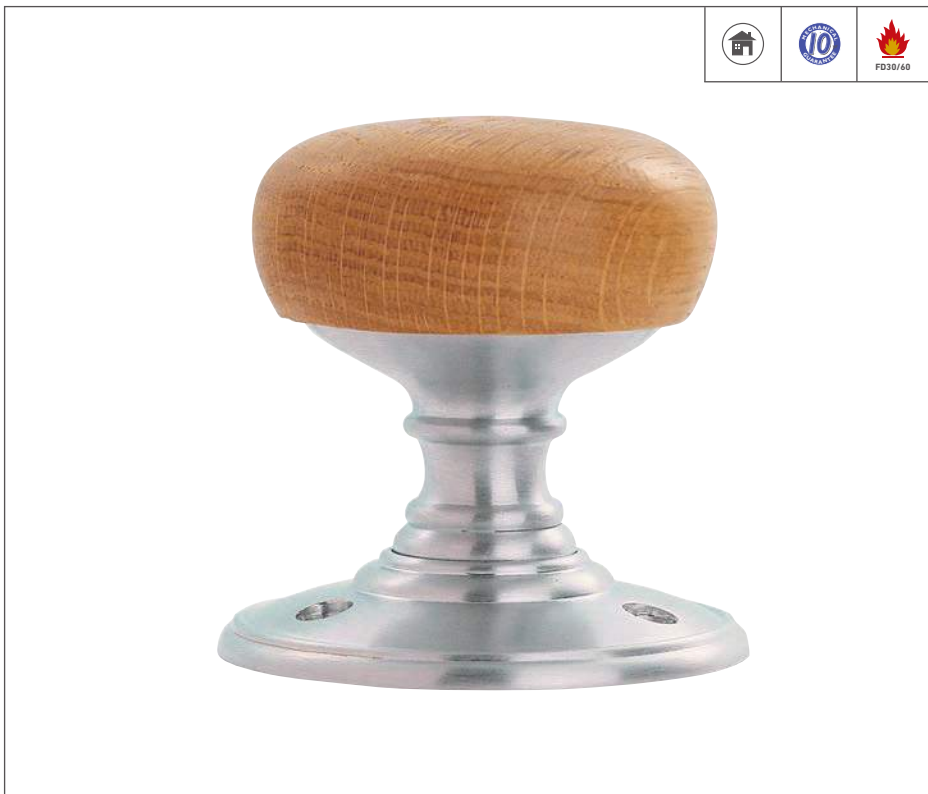

DK32WOSC

WOODEN KNOB
Face Fix Unsprung

Dimensions (mm):
Rose: 70 Dia.
Knob: 60 Dia.
Projection: 71



DELAMAIN

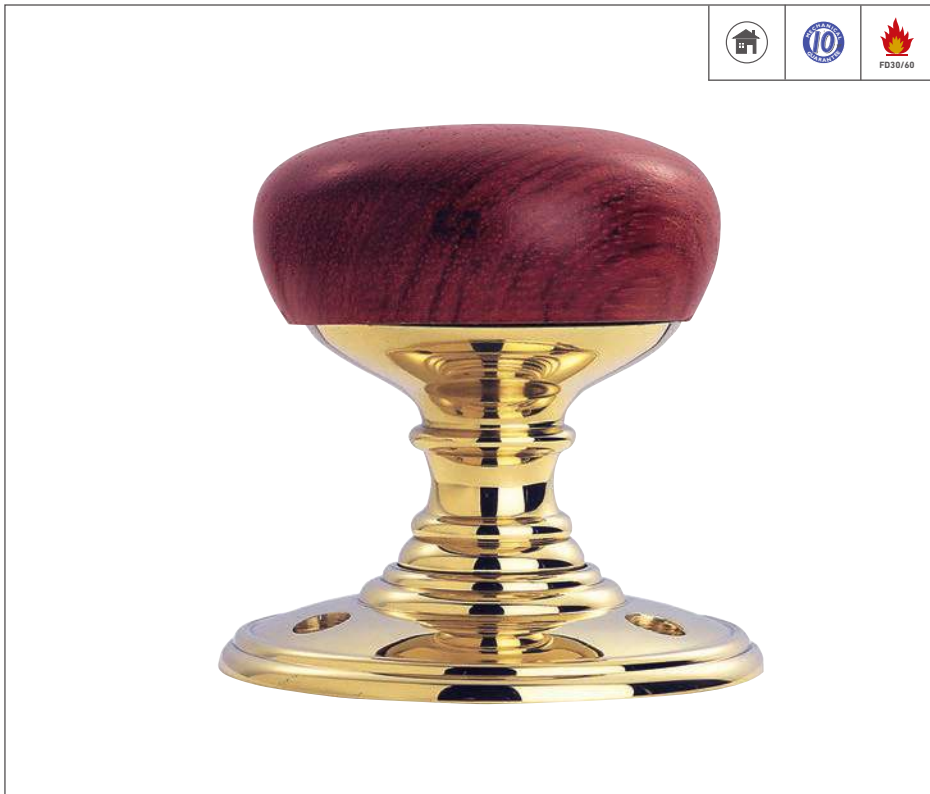

DK32WWPB

WOODEN KNOB
Face Fix Unsprung

Dimensions (mm):
Rose: 70 Dia.
Knob: 60 Dia.
Projection: 71

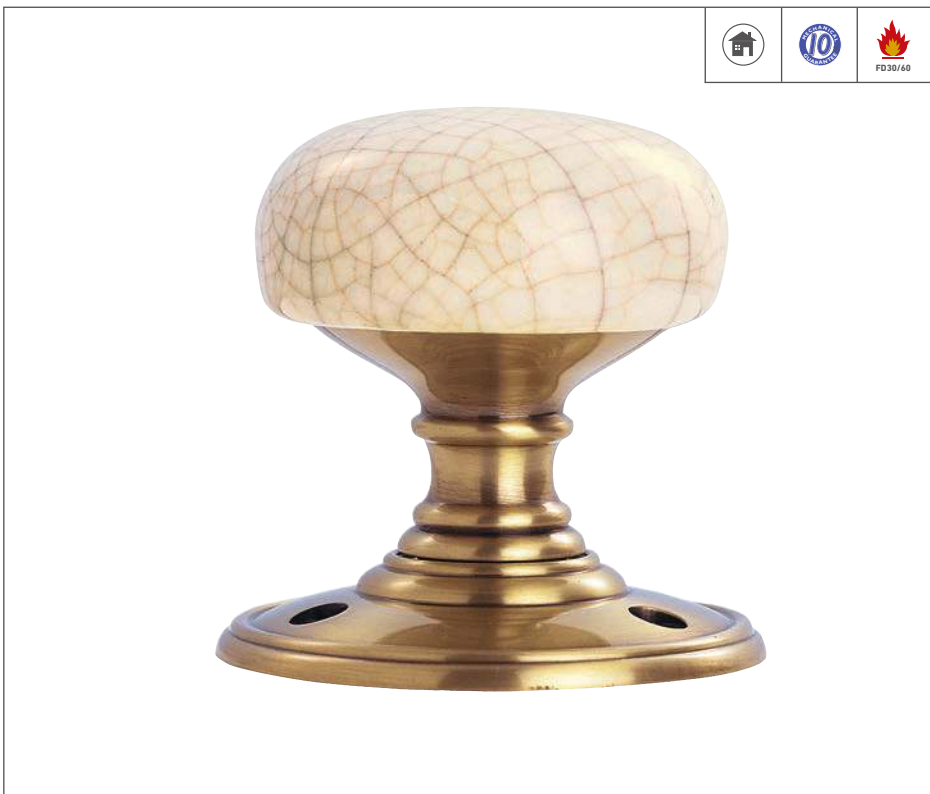

DK34ICFB

PORCELAIN KNOB
Face Fix Unsprung

Dimensions (mm):
Rose: 70 Dia.
Knob: 60 Dia.
Projection: 71



For matching escutcheons DK1/3 and AQ41 see P155-156. For matching bathroom turns DK12/13 see P157.
Unsprung knobs should be used in conjunction with a heavy duty latch.

DELAMAIN

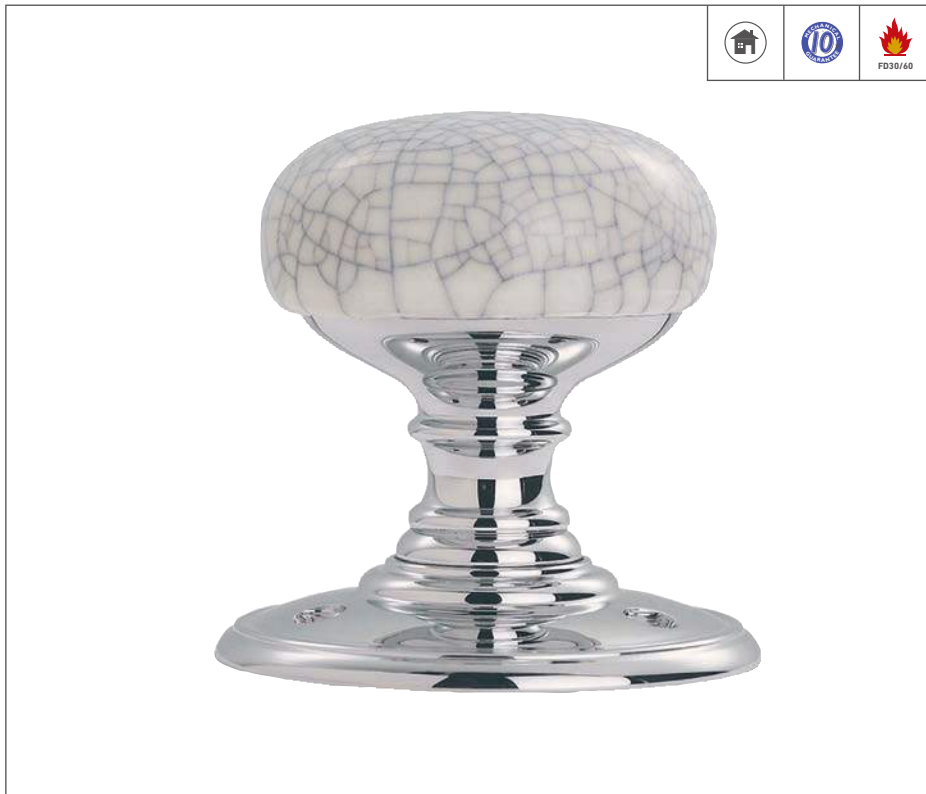

DK34MCCP

PORCELAIN KNOB

Face Fix Unsprung

Dimensions (mm):

Rose:	70 Dia.
Knob:	60 Dia.
Projection:	71



DK34PBKCP

PORCELAIN KNOB

Face Fix Unsprung

Dimensions (mm):

Rose:	70 Dia.
Knob:	60 Dia.
Projection:	71



DELAMAIN



DK34PWSC



PORCELAIN KNOB
Face Fix Unsprung

Dimensions (mm):

Rose:	70 Dia.
Knob:	60 Dia.
Projection:	71

 **PWSC**



DK35



PLAIN KNOB
Face Fix Unsprung

Dimensions (mm):

Rose:	70 Dia.
Knob:	55 Dia.
Projection:	65

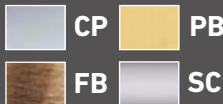
 **CP PB**
FB SC

For matching escutcheons DK1/3 and AQ41 see P155-156. For matching bathroom turns DK12/13 see P157.
Unsprung knobs should be used in conjunction with a heavy duty latch.
DK35 for matching cupboard knob DK47 see P469.

DELAMAIN



DK35C

PLAIN KNOB

Concealed Fix Unsprung

Dimensions (mm):

Rose: 70 Dia.
 Knob: 55 Dia.
 Projection: 67

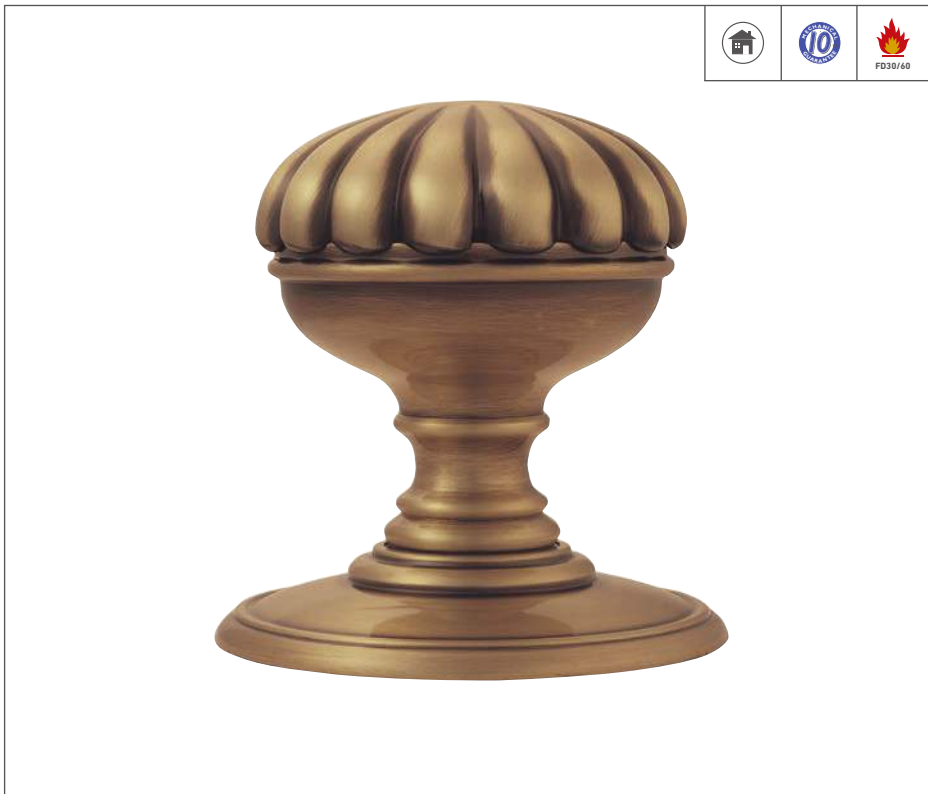

DK36C

FLOWER KNOB

Concealed Fix Unsprung

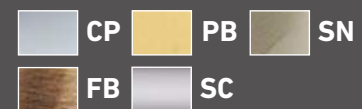

Dimensions (mm):

Rose: 70 Dia.
 Knob: 55 Dia.
 Projection: 75



DELAMAIN



DK37C

REEDED KNOB
Concealed Fix Unsprung

Dimensions (mm):
 Rose: 70 Dia.
 Knob: 50 Dia.
 Projection: 81

CP



PB

SN

FB

SC



DK39C

RINGED KNOB
Concealed Fix Unsprung

Dimensions (mm):
 Rose: 70 Dia.
 Knob: 55 Dia.
 Projection: 64

CP

SC

PB

SN

For matching escutcheons DK1/3 and AQ41 see P155-156. For matching bathroom turns DK12/13 see P157. Unsprung knobs should be used in conjunction with a heavy duty latch. DK37C for matching cupboard knob M1003 see P469. DK39C for matching cupboard knob DK49 see P472.



DELAMAIN

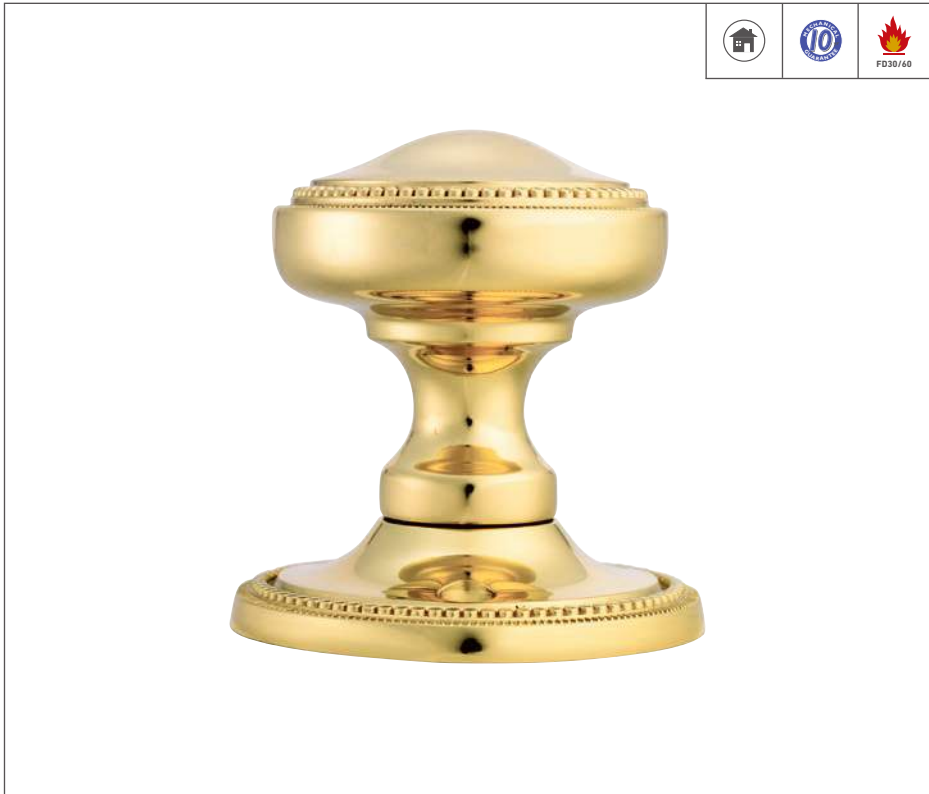

DL250B

BEADED KNOB
Face Fix Unsprung

Dimensions (mm):
Rose: 61 Dia.
Knob: 51 Dia.
Projection: 66

 **PB**

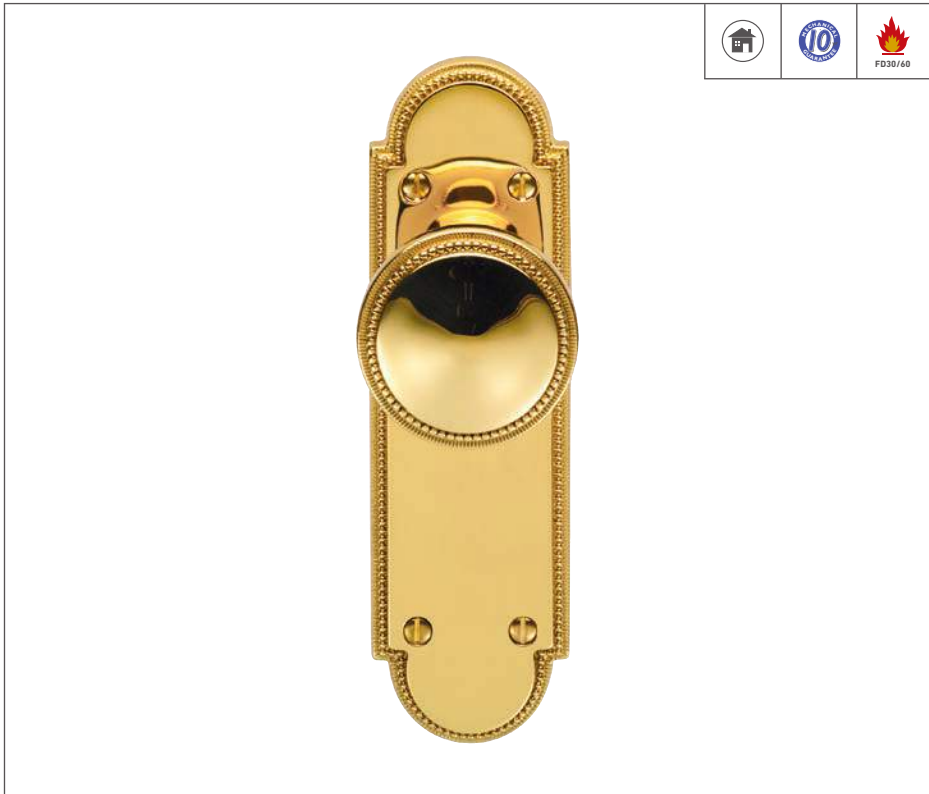

DL261B

BEADED
Knob on Latch Backplate

Dimensions (mm):
Backplate: 172x50
Projection: 65
Knob: 51 Dia.
Plate Thickness: 10

Variations:



DL260B Lock
DL262B Bathroom

Long Plate: 248x50

DL255B Lock
DL256B Latch
DL257B Bathroom

 **PB**



AQ41

ESCUTCHEON
Face Fix

Dimensions (mm):
Rose: 42 Dia.
Rose Thickness: 4

AQ41 Lock

CP

PB

SC

FB

PVD





DK1/3

ESCUTCHEON
Face Fix

Dimensions (mm):
Rose: 55 Dia.
Rose Thickness: 9

DK1 Euro
DK3 Lock

CP



PB

SN

FB

SC



DL1000B

BEADED ESCUTCHEON

Dimensions (mm):
Rose: 32 Dia.
Rose Thickness: 6

PB

DELAMAIN









DK12

LARGE THUMBTURN AND RELEASE
Face Fix

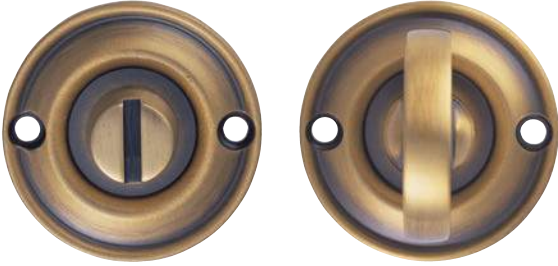
Dimensions (mm):
Rose: 55 Dia.
Rose Thickness: 10

 CP	 PB
 FB	 SC







DK13

SMALL THUMBTURN AND RELEASE
Face Fix

Dimensions (mm):
Rose: 42 Dia.
Rose Thickness: 4

 CP	 PB
 FB	 SC



ALUMINIUM



LRS4000



SAFETY LEVER ON SPRUNG ROSE DDA COMPLIANT

Concealed Fix
Press-on-Rose

Dimensions (mm):

Rose:	52 Dia.
Rose Thickness:	8
Projection:	66
Lever Length:	144
Bar:	22 Dia.

Variations:

LRS4001 Bar 19 Dia.
Lever Length 137



LRS4002



STRAIGHT LEVER ON SPRUNG ROSE

Concealed Fix
Press-on-Rose

Dimensions (mm):

Rose:	52 Dia.
Rose Thickness:	8
Projection:	66
Lever Length:	139
Bar:	19 Dia.



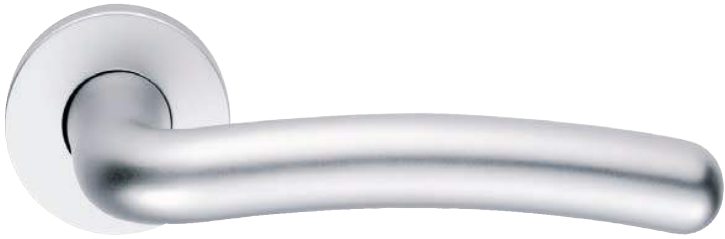

LRS4003

**CURVED LEVER
ON SPRUNG ROSE**
Concealed Fix
Press-on-Rose

Dimensions (mm):

Rose:	52 Dia.
Rose Thickness:	8
Projection:	66
Lever Length:	139
Bar:	19 Dia.

SAA



PAD

D PULL HANDLE

Variations:



PAD4150	150 - Bar 19 Dia.
PAD4225	225 - Bar 19 Dia.
PAD4300	300 - Bar 19 Dia.
PAD4450	450 - Bar 19 Dia.
PAD4600	600 - Bar 19 Dia.
PFD4225	225 - Bar 22 Dia.
PFD4300	300 - Bar 22 Dia.



SAA

For matching escutcheons ESE/ESP/ESU4005 see P196. For matching bathroom turns EST4005 and EST4025 see P196. Blank escutcheon ESB4005 also available. Rose kit FIX4019 available.





ALUMINIUM

	<p>ESE/ESP/ESU4005</p>
	<p>ESCUTCHEON Concealed Fix Press-on-Rose</p> <p>Dimensions (mm): Rose: 52 Dia. Rose Thickness: 8</p> <p>ESE4005 Euro ESP4005 Lock ESU4005 Oval</p> <p> SAA</p>

	<p>EST4005</p>
	<p>THUMBTURN AND RELEASE Concealed Fix Press-on-Rose c/w indicator</p> <p>Dimensions (mm): Rose: 52 Dia. Rose Thickness: 8</p> <p> SAA</p>

	<p>EST4025</p>
	<p>DDA COMPLIANT THUMBTURN AND RELEASE Concealed Fix Press-on-Rose c/w indicator</p> <p>Dimensions (mm): Rose: 52 Dia. Rose Thickness: 8</p> <p> SAA</p>



FIX4019

ROSE KIT

Dimensions (mm):
 Rose: 52 Dia.
 Rose Thickness: 8

SAA







FPP43000

PLAIN FINGER PLATE





Dimensions (mm):
 Plate: 300x75
 Plate Thickness: 2



Variations:

FPP43500 350x75
FPP45000 500x75
FPP46500 650x75

SAA

ALUMINIUM

	   	FPP43001					
	<p>PULL FINGER PLATE</p> <p>Dimensions (mm): Plate: 300x75 Plate Thickness: 2</p> <p>Variations:</p> <table style="width: 100%; border: none;"> <tr> <td style="padding: 2px 10px;">FPP43501</td> <td style="padding: 2px 10px;">350x75</td> </tr> <tr> <td style="padding: 2px 10px;">FPP45001</td> <td style="padding: 2px 10px;">500x75</td> </tr> <tr> <td style="padding: 2px 10px;">FPP46501</td> <td style="padding: 2px 10px;">650x75</td> </tr> </table> <p style="text-align: right; margin-top: 20px;">  SAA </p>		FPP43501	350x75	FPP45001	500x75	FPP46501
FPP43501	350x75						
FPP45001	500x75						
FPP46501	650x75						

	   	FPP43002					
	<p>PUSH FINGER PLATE</p> <p>Dimensions (mm): Plate: 300x75 Plate Thickness: 2</p> <p>Variations:</p> <table style="width: 100%; border: none;"> <tr> <td style="padding: 2px 10px;">FPP43502</td> <td style="padding: 2px 10px;">350x75</td> </tr> <tr> <td style="padding: 2px 10px;">FPP45002</td> <td style="padding: 2px 10px;">500x75</td> </tr> <tr> <td style="padding: 2px 10px;">FPP46502</td> <td style="padding: 2px 10px;">650x75</td> </tr> </table> <p style="text-align: right; margin-top: 20px;">  SAA </p>		FPP43502	350x75	FPP45002	500x75	FPP46502
FPP43502	350x75						
FPP45002	500x75						
FPP46502	650x75						









SIGNS







Dimensions (mm):







FPA4301	Pull Symbol	75x30
FPA4302	Push Symbol	75x30
SEX4011	Male Symbol	75 Dia.
SEX4012	Female Symbol	75 Dia.
SEX4014	Shower Symbol	75 Dia.
SEX4015	Fire Door Keep Locked	75 Dia.
SEX4016	Fire Door Keep Shut	75 Dia.
SEX4017	Disabled Symbol	75 Dia.
SEX4018	Unisex Symbol	75 Dia.
SEX4019	Baby Change Symbol	75 Dia.





ALUMINIUM



	   	ECP4000
	<p>EURO CYLINDER PULL</p> <p>Dimensions (mm): Overall: 97x43</p> <p style="text-align: right;"> SAA</p>	

	   	OCP4000
	<p>OVAL CYLINDER PULL</p> <p>Dimensions (mm): Overall: 97x43</p> <p style="text-align: right;"> SAA</p>	

	   	RCP4000
	<p>RIM CYLINDER PULL</p> <p>Dimensions (mm): Overall: 68x43</p> <p style="text-align: right;"> SAA</p>	



		FPH4100
		<p>FLUSH PULL</p> <p>Dimensions (mm): Overall: 100x50</p> <p> SAA</p>

		DSF4032
		<p>FLOOR MOUNTED DOOR STOP</p> <p>Dimensions (mm): Overall: 50x40</p> <p> SAA</p>

		DSW6001
		<p>WALL MOUNTED DOOR STOP</p> <p>Dimensions (mm): Overall: 72</p> <p> PAA</p>

ALUMINIUM



BBT4100

STRAIGHT BARREL BOLT



Dimensions (mm):
Overall: 102x25

Variations:

BBT4150	152x32
BBT4200	203x32

SAA



BBT4100CR

CRANKED BARREL BOLT

Dimensions (mm):
Overall: 102x25

Variations:

BBT4150CR	152x32
------------------	--------

SAA

FBT4006
LEVER ACTION FLUSH BOLT
Dimensions (mm):

Overall: 152x19

Variations:
FBT4008 203x19

FBT4010 254x19

SAA

LPB4004
CONTRACT

Lever on Latch Backplate

Dimensions (mm):

Backplate: 103x40

Projection: 56

Lever Length: 106

Plate Thickness: 10

Long Plate: 154x40



LPP4004 Lock







LPT4004 Bathroom

LPE4004 Euro 47.5c/c





SAA

ALUMINIUM

					SAA21													
	<p>CONTRACT Lever on Lock Backplate</p> <p>Dimensions (mm):</p> <table style="width: 100%; border: none;"> <tr><td>Backplate:</td><td style="text-align: right;">155x41</td></tr> <tr><td>Projection:</td><td style="text-align: right;">55</td></tr> <tr><td>Lever Length:</td><td style="text-align: right;">110</td></tr> <tr><td>Plate Thickness:</td><td style="text-align: right;">10</td></tr> </table> <p>Variations:</p> <table style="width: 100%; border: none;"> <tr><td>SAA21Y</td><td style="text-align: right;">Euro 47.5c/c</td></tr> <tr><td>SAA21WC</td><td style="text-align: right;">Bathroom</td></tr> <tr><td>SAA21U</td><td style="text-align: right;">Oval 48.5c/c</td></tr> </table> <p>Short Plate: 103x40</p> <p>SAA22 Latch</p> <div style="text-align: right; margin-top: 10px;">  SAA </div>					Backplate:	155x41	Projection:	55	Lever Length:	110	Plate Thickness:	10	SAA21Y	Euro 47.5c/c	SAA21WC	Bathroom	SAA21U
Backplate:	155x41																	
Projection:	55																	
Lever Length:	110																	
Plate Thickness:	10																	
SAA21Y	Euro 47.5c/c																	
SAA21WC	Bathroom																	
SAA21U	Oval 48.5c/c																	

					SAA51											
	<p>CONTRACT Lever on Latch Backplate</p> <p>Dimensions (mm):</p> <table style="width: 100%; border: none;"> <tr><td>Backplate:</td><td style="text-align: right;">103x40</td></tr> <tr><td>Projection:</td><td style="text-align: right;">63</td></tr> <tr><td>Lever Length:</td><td style="text-align: right;">107</td></tr> <tr><td>Plate Thickness:</td><td style="text-align: right;">10</td></tr> </table> <p>Long Plate Variations: 151x44</p> <table style="width: 100%; border: none;"> <tr><td>SAA50</td><td style="text-align: right;">Lock</td></tr> <tr><td>SAA50WC</td><td style="text-align: right;">Bathroom</td></tr> </table> <div style="text-align: right; margin-top: 10px;">  SAA </div>					Backplate:	103x40	Projection:	63	Lever Length:	107	Plate Thickness:	10	SAA50	Lock	SAA50WC
Backplate:	103x40															
Projection:	63															
Lever Length:	107															
Plate Thickness:	10															
SAA50	Lock															
SAA50WC	Bathroom															









SAA60

MIAL
Lever on Lock Backplate

Dimensions (mm):
 Backplate: 152x38
 Projection: 51
 Lever Length: 102
 Plate Thickness: 10

Variations:
SAA60Y Euro 47.5c/c
SAA60WC Bathroom
Short Plate: 102x38
SAA61 Latch

 **SAA**







SAA28

HAT AND COAT HOOK



Dimensions (mm):
 Overall: 130x19

 **SAA**

ALUMINIUM

	<p>SAA23</p>
	<p>LETTERPLATE</p> <p>Dimensions (mm): Outer Frame: 250x78</p> <p> SAA</p>

	<p>SAA26</p>
	<p>LETTER TIDY</p> <p>Dimensions (mm): Outer Frame: 255x68</p> <p> SAA</p>

	<p>SAAIND</p>
	<p>INDICATOR BOLT</p> <p>Dimensions (mm): Overall: 70x32</p> <p> SAA</p>

ALUMINIUM







LRS9000

SAFETY LEVER ON SPRUNG ROSE DDA COMPLIANT
 Concealed Fix
 Press-on-Rose

Dimensions (mm):
 Rose: 52 Dia.
 Rose Thickness: 8
 Projection: 69
 Lever Length: 145
 Bar: 22 Dia.

Variations:
LRS9001 Bar 19 Dia.
 Lever Length 140
LRS9001U Bar 19 Dia.
 Lever Length 140
 Unsprung

 **SAA**





LRS9002



STRAIGHT LEVER ON SPRUNG ROSE
 Concealed Fix
 Press-on-Rose

Dimensions (mm):
 Rose: 52 Dia.
 Rose Thickness: 8
 Projection: 69
 Lever Length: 139
 Bar: 19 Dia.

 **SAA**

For matching escutcheons ESE/ESP/ESU9005 see P210. For matching bathroom turns EST9005 and EST9025 see P210. Blank escutcheon ESB9005 also available.

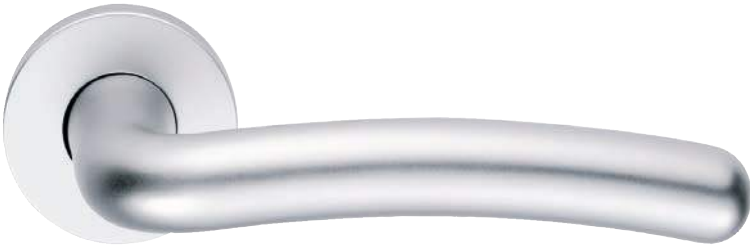
ALUMINIUM

		<p>LRS9003</p>									
	<p>CURVED LEVER ON SPRUNG ROSE Concealed Fix Press-on-Rose</p> <p>Dimensions (mm):</p> <table> <tr> <td>Rose:</td> <td>52 Dia.</td> </tr> <tr> <td>Rose Thickness:</td> <td>8</td> </tr> <tr> <td>Projection:</td> <td>66</td> </tr> <tr> <td>Lever Length:</td> <td>139</td> </tr> <tr> <td>Bar:</td> <td>19 Dia.</td> </tr> </table> <p> SAA</p>		Rose:	52 Dia.	Rose Thickness:	8	Projection:	66	Lever Length:	139	Bar:
Rose:	52 Dia.										
Rose Thickness:	8										
Projection:	66										
Lever Length:	139										
Bar:	19 Dia.										

		<p>LRS9005</p>									
	<p>MITRED LEVER ON SPRUNG ROSE Concealed Fix Press-on-Rose</p> <p>Dimensions (mm):</p> <table> <tr> <td>Rose:</td> <td>52 Dia.</td> </tr> <tr> <td>Rose Thickness:</td> <td>8</td> </tr> <tr> <td>Projection:</td> <td>69</td> </tr> <tr> <td>Lever Length:</td> <td>132</td> </tr> <tr> <td>Bar:</td> <td>19 Dia.</td> </tr> </table> <p> SAA</p>		Rose:	52 Dia.	Rose Thickness:	8	Projection:	69	Lever Length:	132	Bar:
Rose:	52 Dia.										
Rose Thickness:	8										
Projection:	69										
Lever Length:	132										
Bar:	19 Dia.										

PAD/PFD
D PULL HANDLE
Variations:



PAD9150	150c/c - Bar 19 Dia.
PAD9225	225c/c - Bar 19 Dia.
PAD9300	300c/c - Bar 19 Dia.
PFD9150	150c/c - Bar 22 Dia.
PFD9225	225c/c - Bar 22 Dia.
PFD9300	300c/c - Bar 22 Dia.
PFD9450	450c/c - Bar 22 Dia.
PFD9600	600c/c - Bar 22 Dia.



FIX9005
ROSE KIT
Dimensions (mm):



Rose:	52
Rose Thickness:	8



ALUMINIUM

	<p>ESE/ESP/ESU9005</p>
	<p>ESCUTCHEON Concealed Fix Press-on-Rose</p> <p>Dimensions (mm): Rose: 52 Dia. Rose Thickness: 8</p> <p>ESE9005 Euro ESP9005 Lock ESU9005 Oval</p> <p> SAA</p>

	<p>EST9005</p>
	<p>THUMBTURN AND RELEASE Concealed Fix 2 Part Screw-on-Rose c/w indicator</p> <p>Dimensions (mm): Rose: 52 Dia. Rose Thickness: 8</p> <p> SAA</p>

	<p>EST9025</p>
	<p>DDA COMPLIANT THUMBTURN AND RELEASE Concealed Fix 2 Part Screw-on-Rose c/w indicator</p> <p>Dimensions (mm): Rose: 52 Dia. Rose Thickness: 8</p> <p> SAA</p>



EST9625

**DDA COMPLIANT
HANDLE SET**

Dimensions (mm):
Overall: 178x38









BCP9000







BLANK CYLINDER PULL







Dimensions (mm):
Overall: 78x44







ALUMINIUM





	   	ECP9000
	<p>EURO CYLINDER PULL</p> <p>Dimensions (mm): Overall: 78x44</p> <p> SAA</p>	





	   	OCP9000
	<p>OVAL CYLINDER PULL</p> <p>Dimensions (mm): Overall: 78x44</p> <p> SAA</p>	

	   	PCP9000
	<p>LOCK CYLINDER PULL</p> <p>Dimensions (mm): Overall: 78x44</p> <p> SAA</p>	

ALUMINIUM

	   	RCP9000
	<p>RIM CYLINDER PULL</p> <p>Dimensions (mm): Overall: 78x44</p> <p> SAA</p>	

	  	DSW9015
	<p>WALL MOUNTED DOOR STOP</p> <p>Dimensions (mm): Diameter: 16</p> <p> SAA</p>	

	  	DSF9030
	<p>FLOOR MOUNTED DOOR STOP</p> <p>Dimensions (mm): Diameter: 30</p> <p> SAA</p>	

ALUMINIUM



DSF9031

**LARGE FLOOR MOUNTED
DOOR STOP**

Dimensions (mm):

Diameter: 78







DSF9032



**FLOOR MOUNTED
DOOR STOP**

Dimensions (mm):

Diameter: 44



	  	HCH9012
	<p>FLAT COAT HOOK</p> <p>Dimensions (mm): Overall: 70x20</p> <p style="text-align: right;"> SAA</p>	

	  	HCH9013
	<p>FLAT HAT AND COAT HOOK</p> <p>Dimensions (mm): Overall: 175x20</p> <p style="text-align: right;"> SAA</p>	

ALUMINIUM



LIP9001

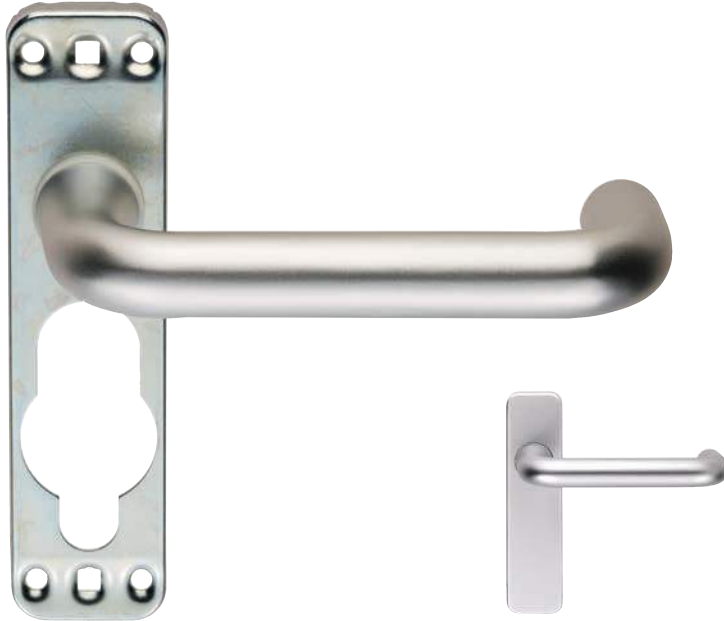

LIP9001 + PLB9001









DDA COMPLIANT SAFETY LEVER ON INNER PLATE

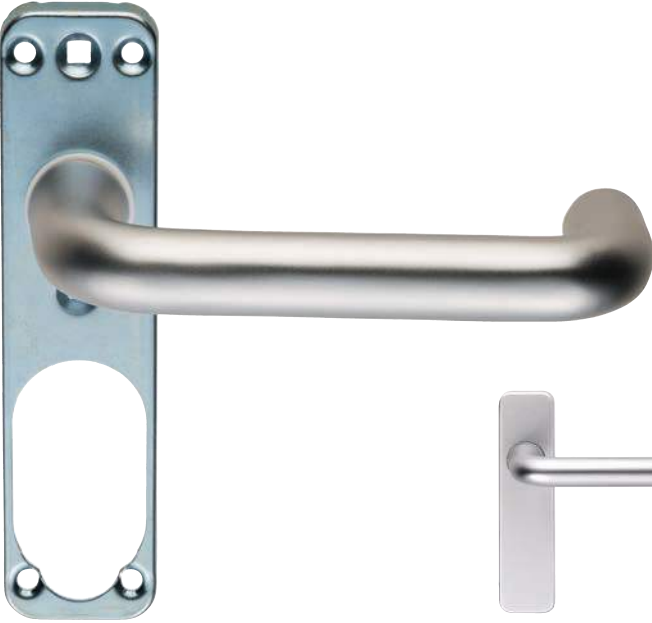

Dimensions (mm):

Backplate:	154x40
Projection:	68
Lever Length:	143
Bar:	19 Dia.
Plate Thickness:	10



	CODE	DESCRIPTION
	PLE9001	Euro Plate - 47.5 c/c
	PLB9001	Latch Plate
	PLP9001	Lock Plate
	PLT9001	Bathroom Plate + Indicator + Turn



	     	<p>LIP9001/DIN</p> <p>DDA COMPLIANT SAFETY LEVER ON INNER PLATE DIN</p> <p>Dimensions (mm):</p> <p>Backplate: 154x40 Projection: 68 Lever Length: 143 Bar: 19 Dia. Plate Thickness: 10</p> <p> SAA</p>
	 <p>LIP9001 + PLB9001</p>	

	CODE	DESCRIPTION
	PLE9001/72	Euro Plate - Din 72 c/c
	PLT9001/78	Bathroom Plate - Din 78 c/c + Indicator + Turn

Carlisle Brass Accessories, Bolts and Hooks







AQ45

COVERED ESCUTCHEON
Peardrop

Dimensions (mm):
Overall: 60x18

 CP  PB









AA4

SQUARE ESCUTCHEON

Dimensions (mm):
Overall: 50x50

 PB











M41

FLAT ESCUTCHEON

Dimensions (mm):
Rose: 31 Dia.

 CP  PB  SC











M42

COVERED ESCUTCHEON

Dimensions (mm):
Rose: 32 Dia.

 CP
 PB
 SC











DK4

LARGE COVERED ESCUTCHEON

Dimensions (mm):
Overall: 73x23

 CP
 PB
 SC





DK6

STEPPED OVAL COVERED ESCUTCHEON

Dimensions (mm):
Overall: 60x30

 CP
 PB
 SC



AQ90



FLUSH PULL

Dimensions (mm):

Overall: 102x45



SP104



SPARE THUMBTURN AND RELEASE SPINDLE

Dimensions (mm):

Overall Length: 90
Spindle: 4.9x67

Variations:

SP104L

Overall Length: 104
Spindle: 4.9x80



SP104L not available in CP or PB finish.



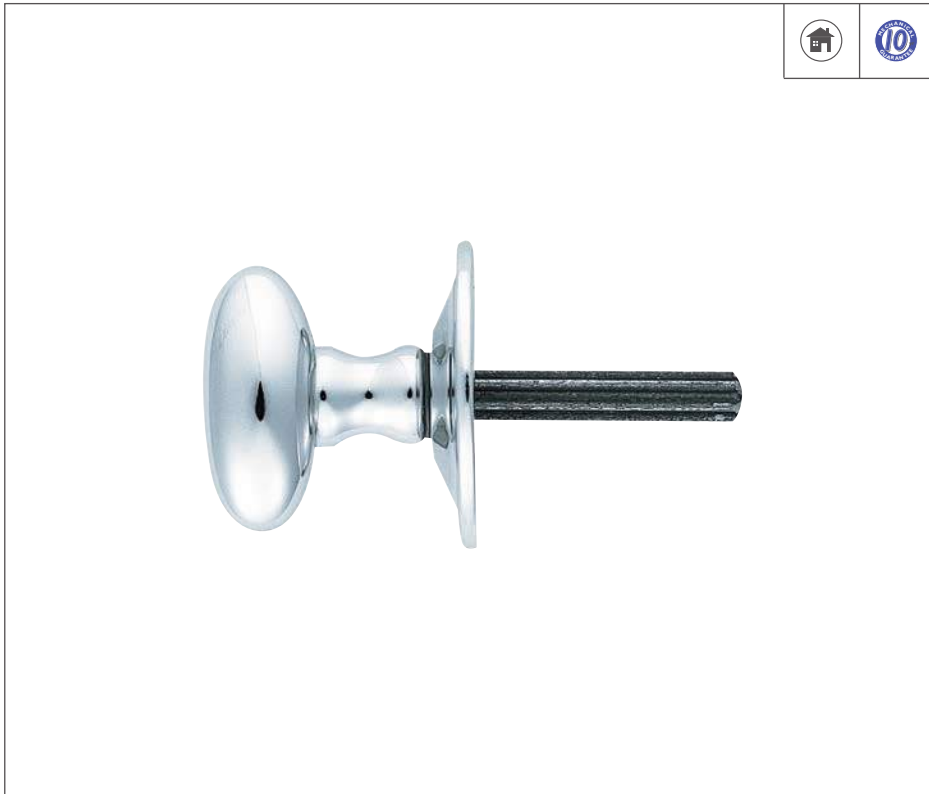

AA33

OVAL THUMBTURN
To Operate Rack Bolt
(Hardened Steel Spindle)

Dimensions (mm):
Rose: 37 Dia.
Knob: 32x20

- BA PB
- CP SC



AA133

OVAL THUMBTURN AND RELEASE
5mm Spindle for Bathroom Lock

Dimensions (mm):
Rose: 32 Dia.
Knob: 32x20

- BA PB
- CP SC



AA32

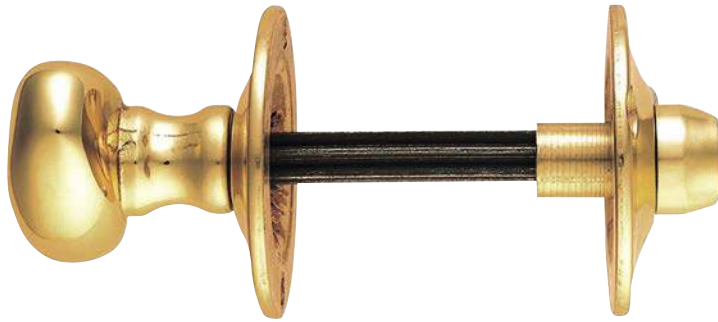

**OVAL THUMBTURN
AND RELEASE**
4.5 x 45mm Spline Spindle

Dimensions (mm):
Rose: 37 Dia.
Knob: 32x20



AA62





**SILENT PATTERN
CABIN HOOK**

Dimensions (mm):
Length: 152

Variations:
AA63 202
AA64 254
AA65 305
AA60 Lightweight 76
AA61 Lightweight 102











AA25

HAT AND COAT HOOK

Dimensions (mm):
 Height: 132
 Projection: 65

CP
 PB
 SC









AA26

VICTORIAN ROBE HOOK

Dimensions (mm):
 Height: 46
 Projection: 39

CP
 PB
 SC









AA27

VICTORIAN DOUBLE ROBE HOOK

Dimensions (mm):
 Height: 55
 Projection: 26

CP
 PB
 SC











AA38

HAT AND COAT HOOK

Dimensions (mm):
 Height: 60
 Projection: 86

 CP
  PB







AQ25

HEAVY HAT AND COAT HOOK

Dimensions (mm):
 Height: 141
 Projection: 74

 CP
  PB
  SC





AA84

HEAVY HANDRAIL BRACKET

Dimensions (mm):
 Height: 76
 Projection: 81

Variations:
AA86 Projection 91

 CP
  PB
  SC

AA86 not available in CP or SC finish.





AA85

LIGHT HANDRAIL BRACKET

Dimensions (mm):
 Height: 90
 Projection: 73

CP PB SC



AA21

DOOR STOP WITH ROSE

Dimensions (mm):
 Length: 71

Variations:
AA23 83

CP PB SC



AA22

DOOR STOP

Dimensions (mm):
 Length: 71



Variations:
AA122 116

CP PB SC



AA21 and AA23 contract versions AA21B and AA23B available. Contact our sales office on 01228 511030 for details.







AA20

OVAL FLOOR MOUNTED DOOR STOP

Dimensions (mm):
Base: 45 Dia.

CP
 PB
 SC





DSF5020

FLOOR MOUNTED DOOR STOP



Dimensions (mm):
Diameter: 39

Finish Variations:

DSF2020	PB
DSF3020	CP

CP
 PB
 SC









AA79

SUNK SLIDE FLUSH BOLT

Dimensions (mm):
Overall: 102x17
Shoot Diameter: 8

CP
 PB
 SN





AA813

FLUSH BOLT SOCKET
13mm Slot Size

Dimensions (mm):
Overall: 63x19

 CP
 SN



AQ46
WOOD



AQ47
CONCRETE





AQ46/47



DUST EXCLUDING SOCKET FOR FLUSH BOLTS

Wood Variation: AQ46
Circular Section: 45 Dia.
Hole Size: 12

Concrete Variation: AQ47
Circular Section: 27 Dia.
Hole Size: 12

 CP
 PB
 SC





BR35

BATHROOM INDICATOR BOLT

Dimensions (mm):
Overall: 67x35

 CP
 PB



BR35 aluminium version also available. Contact our sales office on 01228 511030 for details.



AA34

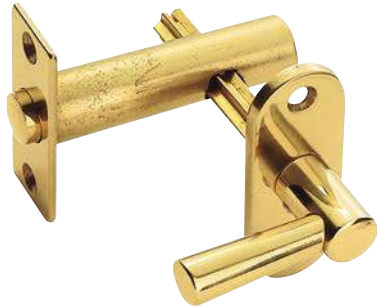

SECURITY BOLT WITH TURN

Dimensions (mm):
Fixing Plate: 55x23



AA35



INDICATOR BOLT WITH EMERGENCY RELEASE

Dimensions (mm):
Fixing Plate: 55x23



DSB8225

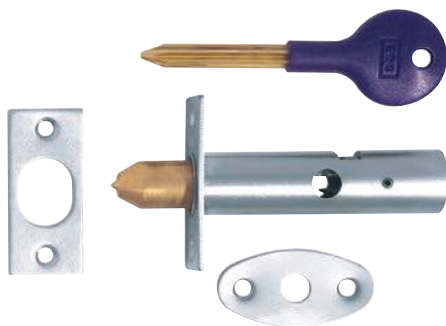

SECURITY DOOR BOLT

Dimensions (mm):
Length: 61
Backset: 32

Variations:
DSB8225L
Length: 86
Backset: 57
DSK8000 Key





ES34

**ESPAÑOLETTE BOLT
OVAL KNOB SET**
With 2 No. x 1.2m
Rods and Mortice Keepers
c/w Locking Keeper

CP PB SC



ES35

**ESPAÑOLETTE BOLT
TEE KNOB SET**
With 2 No. x 1.2m
Rods and Mortice Keepers

CP PB SC



SPESES Spare end saddles, SPESK Angled Keepers and SPESSE Spare saddles available.

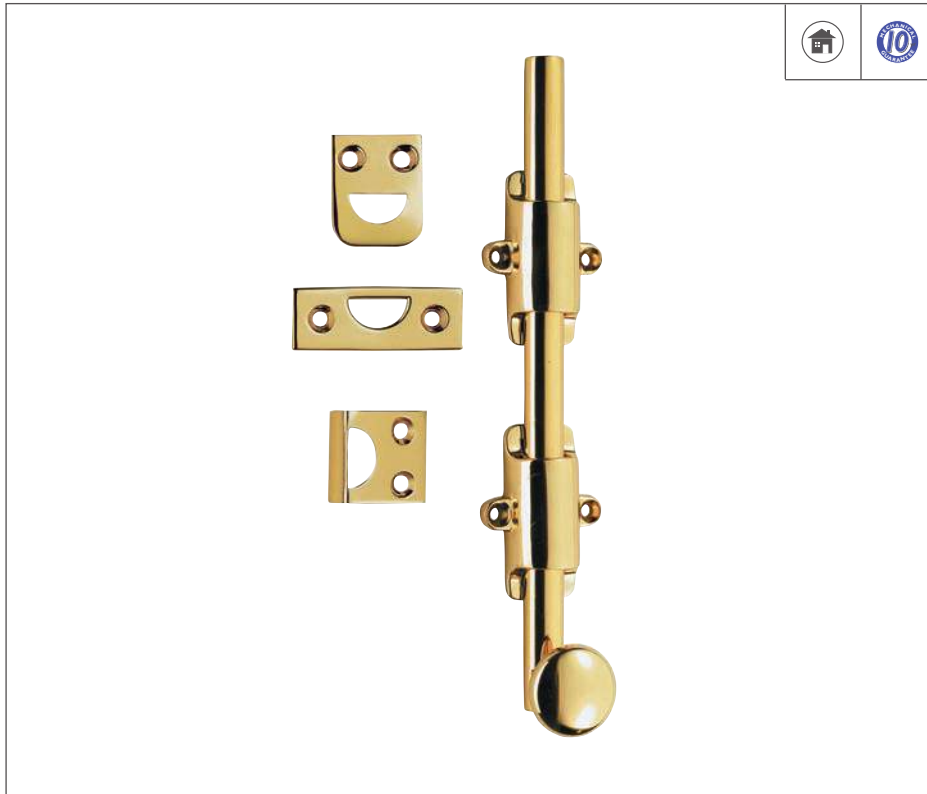

DB8

DUTCH DOOR BOLT
c/w 3 Keeps for Various Applications

Dimensions (mm):
Length: 205

Variations:
DB12 305
DB18 460
DB24 610

CP PB SC

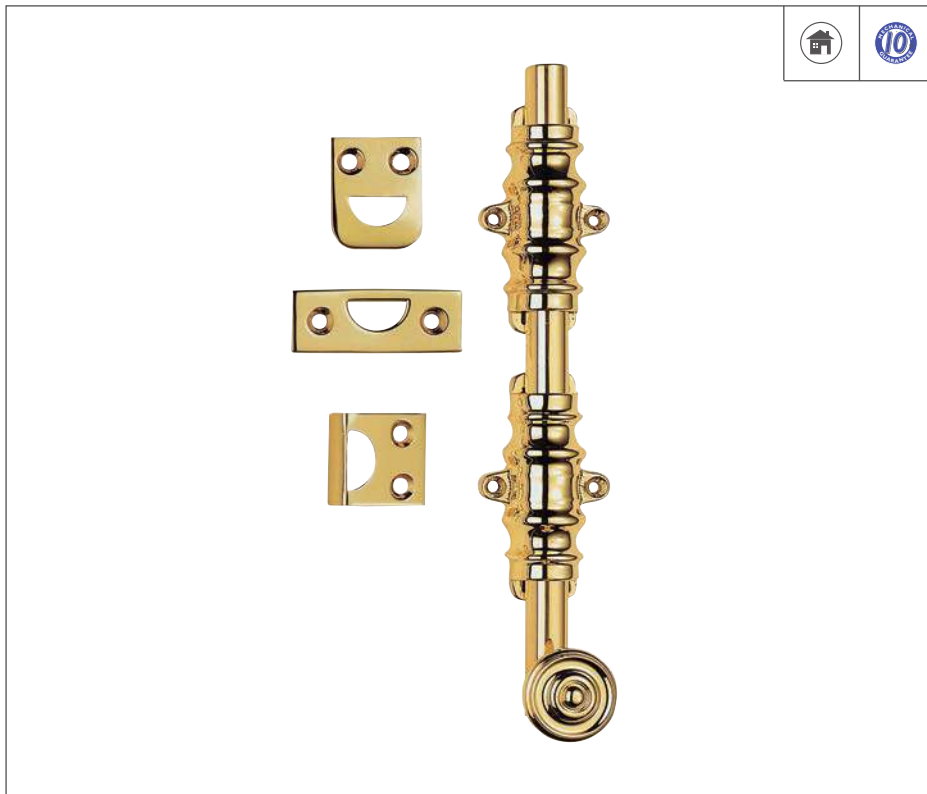

OD8

ARCHITECTURAL SURFACE BOLT
c/w 3 Keeps for Various Applications

Dimensions (mm):
Length: 205

Variations:
OD12 305
OD18 460
OD24 610

PB

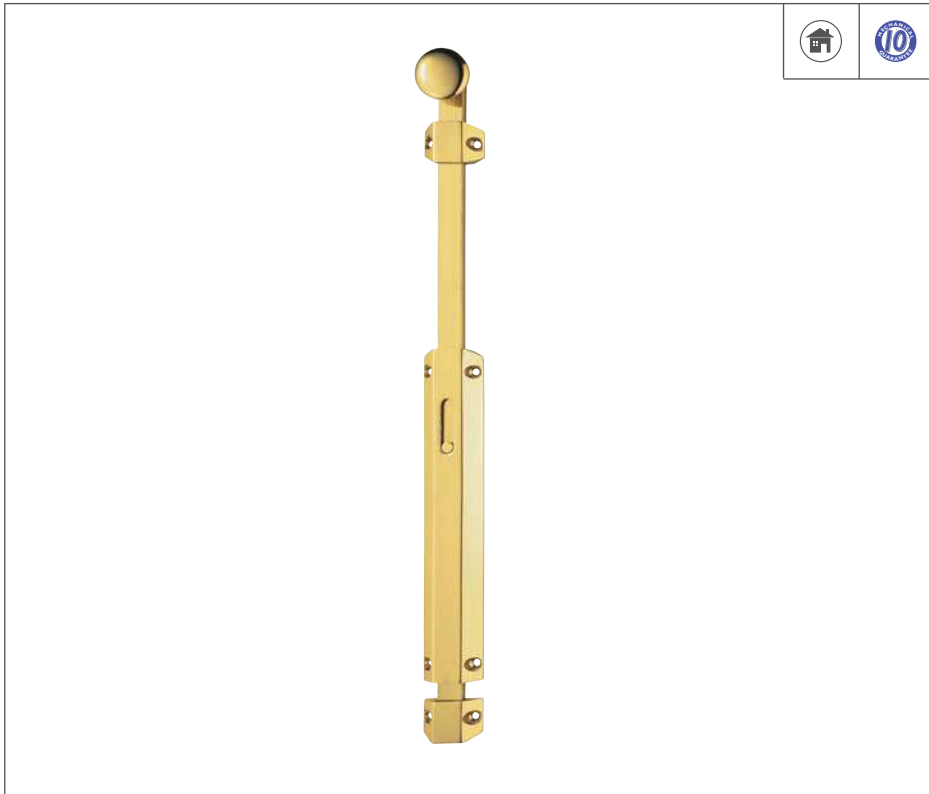

AQ82EX

SURFACE BOLT
 c/w 3 Keeps for Various Applications

Dimensions (mm):
 Extended Bolt: 150
 Overall Length: 355

CP PB SC



AQ82

ARCHITECTURAL SURFACE BOLT
 c/w 3 Keeps for Various Applications

Dimensions (mm):
 Overall: 156x36

Variations:

AQ81 102x36
AQ83 203x36
AQ84 255x36

CP PB SC



AQ83 and AQ84 not available in FB finish.



AA80

LEVER ACTION FLUSH BOLT

Dimensions (mm):

Overall: 152x20
 Shoot Diameter: 11

Variations:

AA81	204x20
AA810	254x20
AA812	305x20
AA818	457x20
AA824	609x20

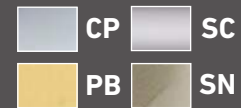

BB3808

BARREL BOLT

Dimensions (mm):

Overall: 202x38

Variations:

BB3204	102x32
BB3206	152x32
BB3208	202x32
BB3806	152x38



AA810 and AA812 not available in SC finish.
 AA818 and AA824 not available in SN finish.



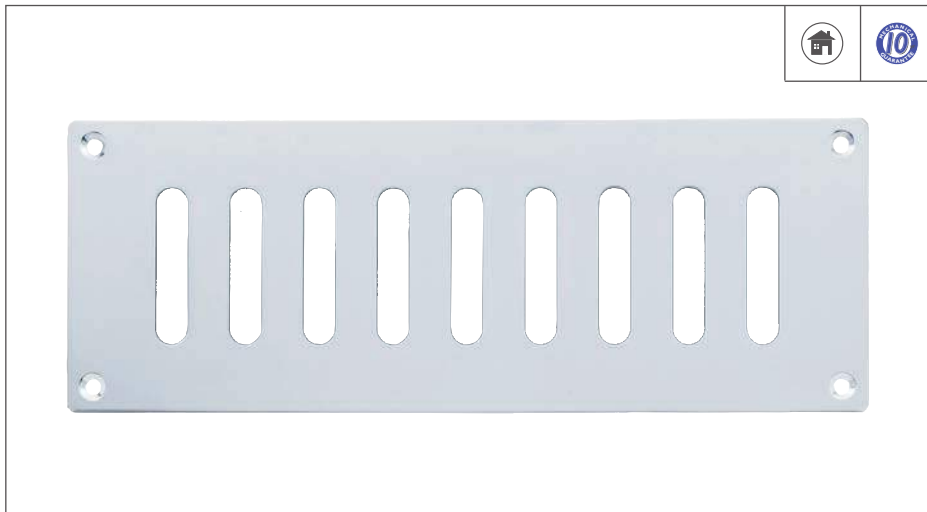

PL4

PLAIN SLOT BRASS VENT
Radius Corners

Dimensions (mm):
Overall: 242x89

Variations:
PL5 242x165

PB SSCP SSSC

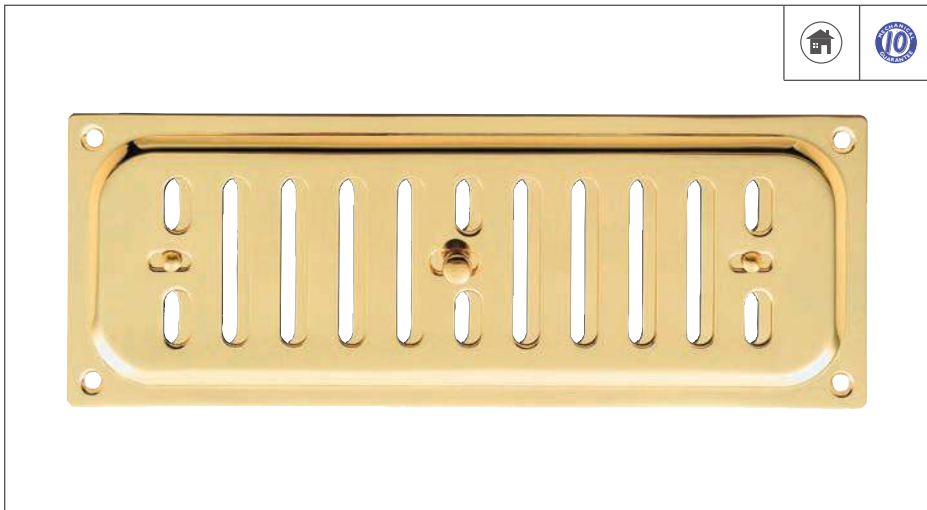

HM4

HIT AND MISS BRASS VENT
Radius Corners

Dimensions (mm):
Overall: 242x89

Variations:
HM3 165x89
HM5 242x165
HM6 242x242

PB SSCP SSSC



HL4

HOODED LOUVRE BRASS VENT
Radius Corners

Dimensions (mm):
Overall: 242x89



Variations:
HL3 165x89
HL5 242x165
HL6 242x242

PB SSCP SSSC



HM3 is not available in SSSC finish. HL3 is not available in SSSC or SSCP finish.
Please note SSCP and SSSC are not dual finish. They are Satin Chrome and Polished Chrome finishes on Stainless Steel.









FRP50



FLUSH RING PULL

Dimensions (mm):
Overall: 50x38

Variations:
FRP63 63x50

 CP
 PB
 SC





DK45

GRAVITY DOOR CATCH



Dimensions (mm):
Backplate: 50x30





 CP
 PB
 SC





Stainless Steel Accessories, Bolts and Hooks





STEELWORX® STAINLESS STEEL



	   	FPH1000
	<p>RECTANGULAR FLUSH PULL</p> <p>Dimensions (mm): Overall: 102x51</p> <p style="text-align: center;"> <input type="checkbox"/> BSS <input type="checkbox"/> SSS </p>	



	   	FPH1001
	<p>RADIUS FLUSH PULL</p> <p>Dimensions (mm): Overall: 120x41</p> <p style="text-align: center;"> <input type="checkbox"/> BSS <input type="checkbox"/> SSS </p>	

	   	FPH1002
	<p>CIRCULAR FLUSH PULL</p> <p>Dimensions (mm): Diameter: 50</p> <p style="text-align: center;"> <input type="checkbox"/> BSS <input type="checkbox"/> SSS </p>	



STEELWORX® STAINLESS STEEL



		FPH1003	
		CIRCULAR FLUSH PULL	
Dimensions (mm): Diameter: 80		<input type="checkbox"/> BSS <input type="checkbox"/> SSS	



		FPH1004	
		CIRCULAR FLUSH PULL	
Dimensions (mm): Diameter: 90		<input type="checkbox"/> BSS <input type="checkbox"/> SSS	

		CAB1100	
		CABIN HOOK GRADE 316	
Dimensions (mm): Length: 100		Variations: CAB1150 150 CAB1200 200	
		<input type="checkbox"/> BSS <input type="checkbox"/> SSS	

STEELWORX® STAINLESS STEEL



		HCH1010	
		HAT AND COAT HOOK	
Dimensions (mm):			
Height:		152	
Projection:		60	
		<input type="checkbox"/> BSS	<input type="checkbox"/> SSS



		HCH1011	
		COAT HOOK	
Dimensions (mm):			
Height:		94	
Projection:		55	
		<input type="checkbox"/> BSS	<input type="checkbox"/> SSS

		HCH1012	
		FLAT COAT HOOK	
Dimensions (mm):			
Height:		74	
Projection:		46	
		<input type="checkbox"/> BSS	<input type="checkbox"/> SSS





STEELWORX® STAINLESS STEEL





		HCH1013
		<p>FLAT HAT AND COAT HOOK</p> <p>Dimensions (mm):</p> <p>Height: 178</p> <p>Projection: 59</p> <p style="text-align: center;"> <input type="checkbox"/> BSS <input type="checkbox"/> SSS </p>





		HCH1014
		<p>HAT AND DOUBLE COAT HOOK</p> <p>Dimensions (mm):</p> <p>Height: 184</p> <p>Projection: 38</p> <p style="text-align: center;"> <input type="checkbox"/> BSS <input type="checkbox"/> SSS </p>

		HCH1015
		<p>DOUBLE COAT HOOK</p> <p>Dimensions (mm):</p> <p>Height: 100</p> <p>Projection: 35</p> <p style="text-align: center;"> <input type="checkbox"/> BSS <input type="checkbox"/> SSS </p>

STEELWORX® STAINLESS STEEL





	   	<p>HCH1016</p> <p>COAT HOOK</p> <p>Dimensions (mm): Diameter: 33 Projection: 45</p> <p> <input type="checkbox"/> BSS <input type="checkbox"/> SSS </p>
-----------------------------------------------------------------------------------	------------------------------------------------------------------------------------------------------------------------------------------------------------------------------------------------------------------------------------------------------------------------------------------------------------------------------------------	---------------------------------------------------------------------------------------------------------------------------------------------------------------------------------------------------------------

	   	<p>HCH1017</p> <p>COAT HOOK Concealed Fix</p> <p>Dimensions (mm): Diameter: 16 Projection: 35</p> <p> <input type="checkbox"/> BSS <input type="checkbox"/> SSS </p>
------------------------------------------------------------------------------------	------------------------------------------------------------------------------------------------------------------------------------------------------------------------------------------------------------------------------------------------------------------------------------------------------------------------------------------	------------------------------------------------------------------------------------------------------------------------------------------------------------------------------------------------------------------------------------------

	   	<p>HCH1018</p> <p>BUFFERED COAT HOOK</p> <p>Dimensions (mm): Rose: 50 Dia. Projection: 93</p> <p> <input type="checkbox"/> BSS <input type="checkbox"/> SSS </p>
-------------------------------------------------------------------------------------	--------------------------------------------------------------------------------------------------------------------------------------------------------------------------------------------------------------------------------------------------------------------------------------------------------------------------------------------------	-------------------------------------------------------------------------------------------------------------------------------------------------------------------------------------------------------------------------

STEELWORX® STAINLESS STEEL



HRB1000/P62

**DDA COMPLIANT
HANDRAIL BRACKET**

Dimensions (mm):
 Height: 88
 Projection: 62

Variations:
HRB1000/P85 Projection 85

BSS SSS







HBS1038

SADDLE
 To suit 38mm dia. handrail

Dimensions (mm):
 Overall:

Variations:
HBS1050 To suit 50mm dia. handrail

BSS SSS







DSF1030

FLOOR MOUNTED DOOR STOP

Dimensions (mm):
 Height: 40
 Diameter: 30

Variations:
DSF1030/C

BSS SSS

STEELWORX® STAINLESS STEEL

DSF1031
**LARGE FLOOR MOUNTED
DOOR STOP**
Dimensions (mm):

 Height: 29
 Diameter: 78

 BSS SSS

DSF1032
**FLOOR MOUNTED
DOOR STOP**
Dimensions (mm):

 Height: 24
 Diameter: 44

 BSS SSS

DSW1015
WALL MOUNTED DOOR STOP
Dimensions (mm):

 Diameter: 16
 Projection: 73

 BSS SSS

 For easy clean flush bolt socket AA813 please see P228.
 HRB1000/P85 is DDA Compliant.

STEELWORX® STAINLESS STEEL







DSW1016

WALL MOUNTED DOOR STOP WITH ROSE

Dimensions (mm):
 Diameter: 22
 Length: 76

Variations:
DSW1017 Length 102

BSS SSS









FBT1008





LEVER ACTION FLUSH BOLT

Dimensions (mm):
 Overall: 200x20
 Shoot Diameter: 11

Variations:
FBT1008/R Radius

BSS SSS



BBT1080

BARREL BOLT





Dimensions (mm):
 Overall: 80x38

Variations:
BBT1100 100x38
BBT1150 150x38
BBT1200 200x38

BSS SSS

STEELWORX® STAINLESS STEEL



BBT1080CR

CRANKED BARREL BOLT





Dimensions (mm):
Overall: 80x38

Variations:

BBT1100CR	100x38
BBT1150CR	150x38
BBT1200CR	200x38

BSS SSS



CPD

CABINET PULL HANDLE

Variations:

CPD1096	96c/c - Bar 10 Dia.
CPD1128	128c/c - Bar 10 Dia.

SSS







CPM

CABINET PULL HANDLE

Variations:

CPM1096	96c/c - Bar 10 Dia.
CPM1128	128c/c - Bar 10 Dia.

SSS

Traditional Black Antique Range



LUDLOW BLACK ANTIQUE



LF56NP92

STRAIGHT NARROW PLATE

Dimensions (mm):

Backplate:	218x30
Projection:	60
Lever Length:	120
Centres:	92

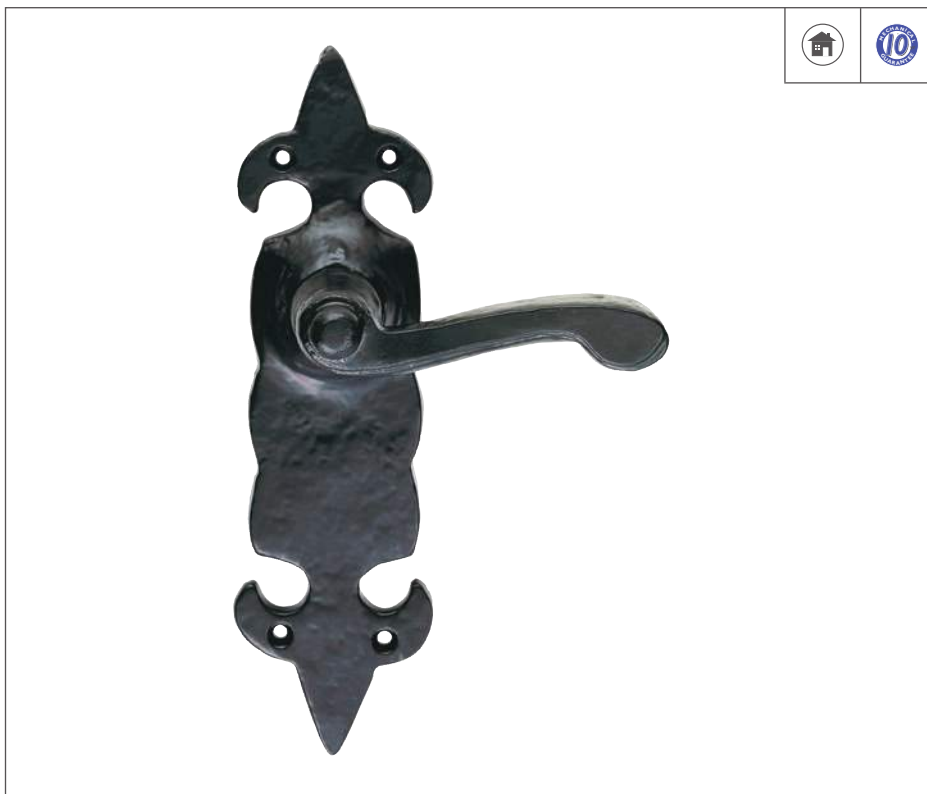

LF5505

FLEUR DE LYS

Lever on Latch Backplate

Dimensions (mm):

Backplate:	209x57
Projection:	52
Lever Length:	100



Variations:

LF5504	Lock
LF5506	Bathroom



LUDLOW BLACK ANTIQUE







LF5502

TRADITIONAL
Lever on Latch Backplate

Dimensions (mm):
 Backplate: 156x54
 Projection: 68
 Lever Length: 96

Variations:
LF5501 Lock
LF5503 Bathroom
LF5501Y Euro 47.5c/c



BA





LF5518

TRADITIONAL V
Lever on Bathroom Backplate

Dimensions (mm):
 Backplate: 156x54
 Projection: 57
 Lever Length: 109

Variations:
LF5516 Lock
LF5517 Latch



BA

LUDLOW BLACK ANTIQUE





LF5507Y

SLIMLINE V
Lever on Euro Backplate



Dimensions (mm):
 Backplate: 158x38
 Projection: 58
 Lever Length: 109

Variations:

LF5507	Lock
LF5508	Latch
LF5509	Bathroom

 **BA**



LF5116

CURLY TAIL
Lever on Lock Backplate

Dimensions (mm):
 Backplate: 167x51
 Projection: 53
 Lever Length: 120

Variations:

LF5117	Latch
LF5118	Bathroom

 **BA**

LUDLOW BLACK ANTIQUE

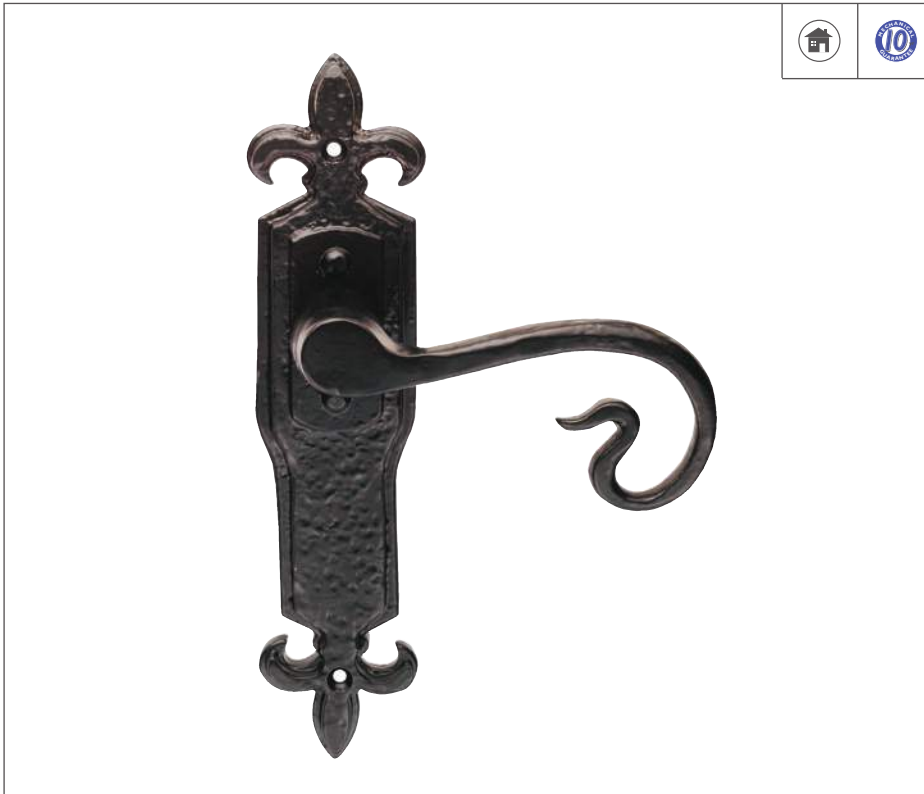

LF5111

CURLY TAIL ON GOTHIC BACKPLATE

Lever on Latch Backplate

Dimensions (mm):

Backplate: 222x50
 Projection: 50
 Lever Length: 120

Variations:

LF5110 Lock
 LF5112 Bathroom

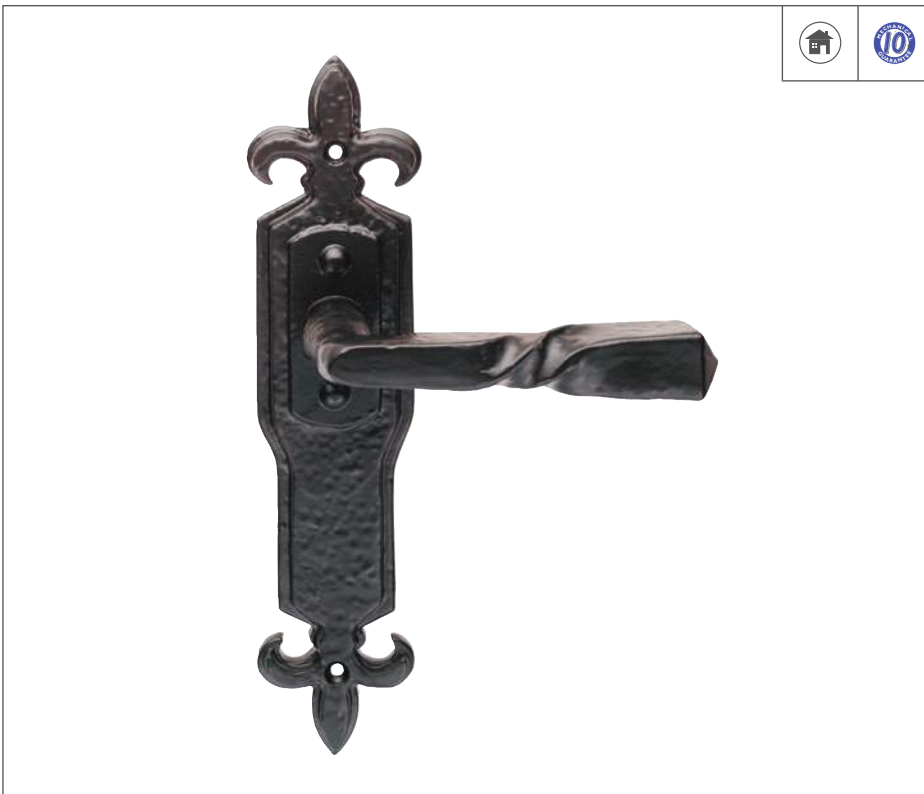
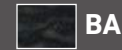

LF5114

BARLEY TWIST ON GOTHIC BACKPLATE

Lever on Latch Backplate

Dimensions (mm):

Backplate: 222x50
 Projection: 64
 Lever Length: 120

Variations:

LF5113 Lock
 LF5115 Bathroom



LUDLOW BLACK ANTIQUE



LF5594

BALL MORTICE KNOB
Half Sprung

Dimensions (mm):

Rose:	60 Dia.
Knob:	45 Dia.
Projection:	67

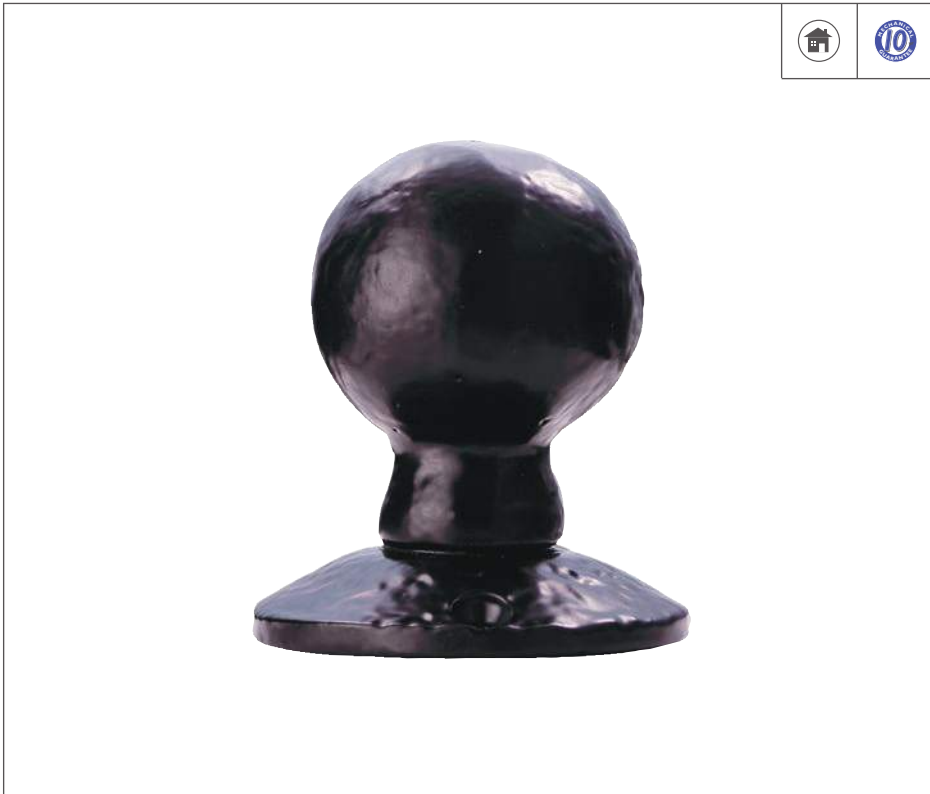
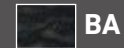

LF5594R

BALL RIM KNOB

Dimensions (mm):

Rose:	60 Dia.
Knob:	45 Dia.
Projection:	67

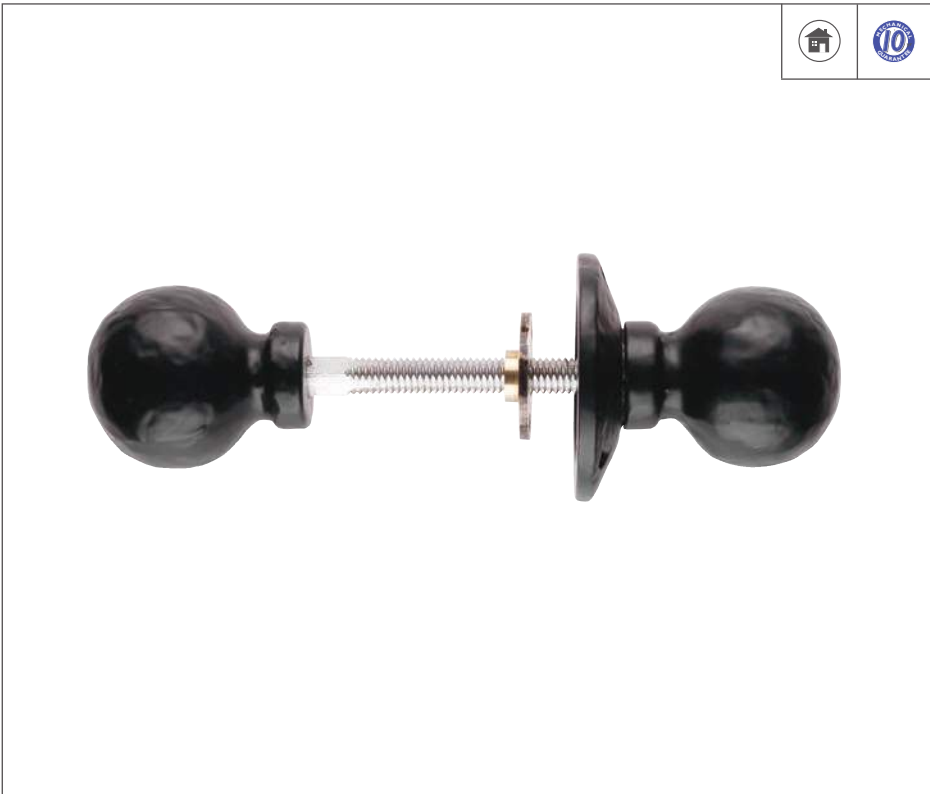

LUDLOW BLACK ANTIQUE

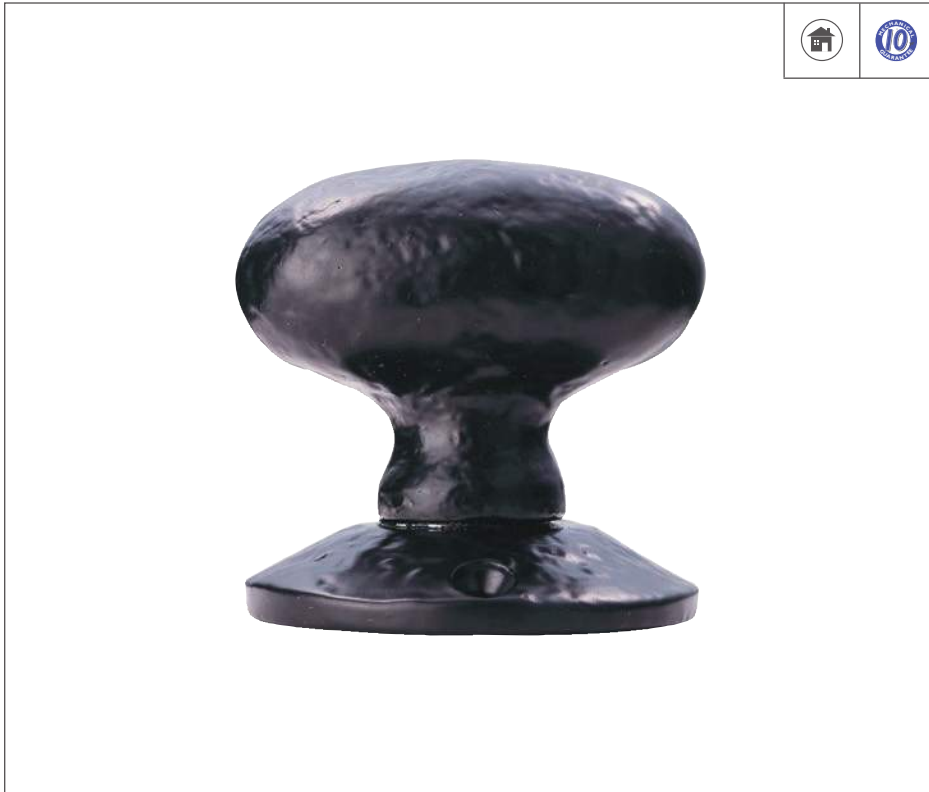

LF5595

OVAL MORTICE KNOB
Half Sprung

Dimensions (mm):
Rose: 60 Dia.
Knob: 64x36
Projection: 60







LF5550





**OCTAGONAL CENTRE
DOOR KNOB**





Dimensions (mm):
Rose: 62 Dia.
Knob: 62 Dia.
Projection: 57







LUDLOW BLACK ANTIQUE





	 	LF5533Y
		<p>EURO SHIELD ESCUTCHEON</p> <p>Dimensions (mm): Overall: 60x38</p> <p> BA</p>



	 	LF5539U
		<p>STANDARD PROFILE ON OVAL SHAPE ESCUTCHEON</p> <p>Dimensions (mm): Overall: 51x34</p> <p> BA</p>

	 	LF5546
		<p>STANDARD COVERED ESCUTCHEON</p> <p>Dimensions (mm): Diameter: 40</p> <p> BA</p>

LUDLOW BLACK ANTIQUE

	 	LF5539
		<p>EURO ESCUTCHEON</p> <p>Dimensions (mm): Diameter: 52</p> <p> BA</p>

	 	LF5532
		<p>FLEUR DE LYS ESCUTCHEON</p> <p>Dimensions (mm): Overall: 83x28</p> <p> BA</p>

	 	LF5533
		<p>SHIELD COVERED ESCUTCHEON</p> <p>Dimensions (mm): Overall: 58x31</p> <p> BA</p>

LUDLOW BLACK ANTIQUE



LF5531

FLORAL ESCUTCHEON

Dimensions (mm):

Overall: 48x35



BA



LF5538

**PLAQUE COVERED
ESCUTCHEON**

Dimensions (mm):

Overall: 45x29



BA

LUDLOW BLACK ANTIQUE



LF5525

**FLEUR DE LYS
LETTER PLATE**

Dimensions (mm):

Overall:	365x90
Aperture:	195x45
Fixing Centres:	250



BA



LF5524

**TRADITIONAL
LETTERPLATE**

Dimensions (mm):

Overall:	268x91
Aperture:	196x46
Fixing Centres:	233



BA

LUDLOW BLACK ANTIQUE



AA55BA

LETTER TIDY

Dimensions (mm):

Overall: 300x85



LF5543

**FLEUR DE LYS
RIM CYLINDER PULL**

Dimensions (mm):

Overall: 142x64



LUDLOW BLACK ANTIQUE

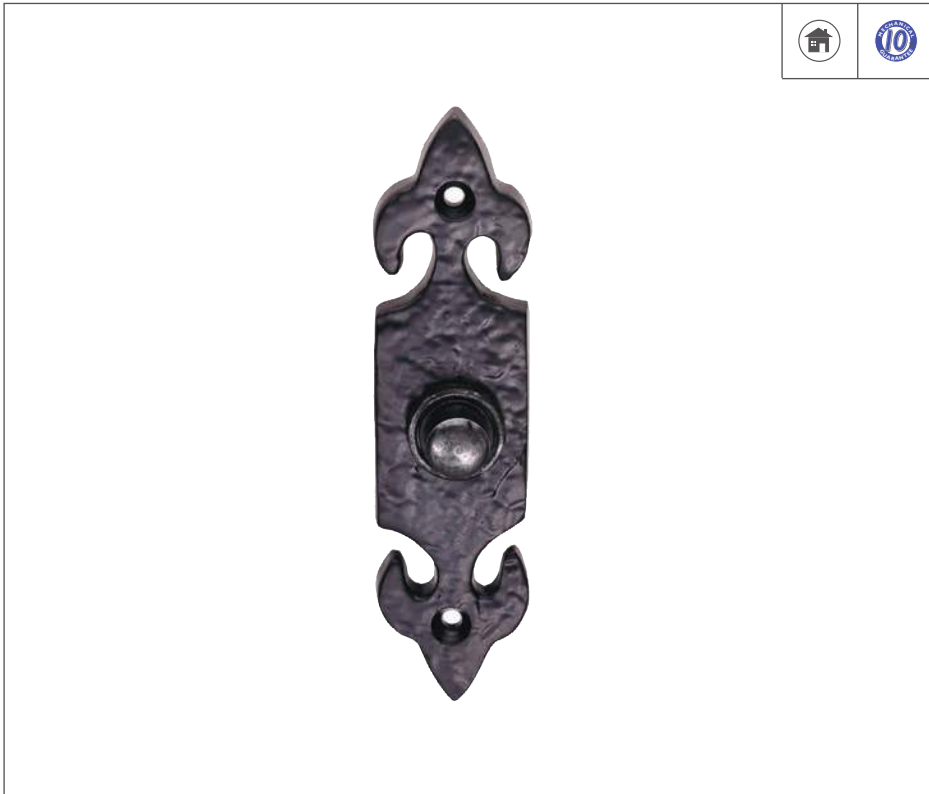

LF5534

FLEUR DE LYS BELL PUSH

Dimensions (mm):

Overall: 120x30

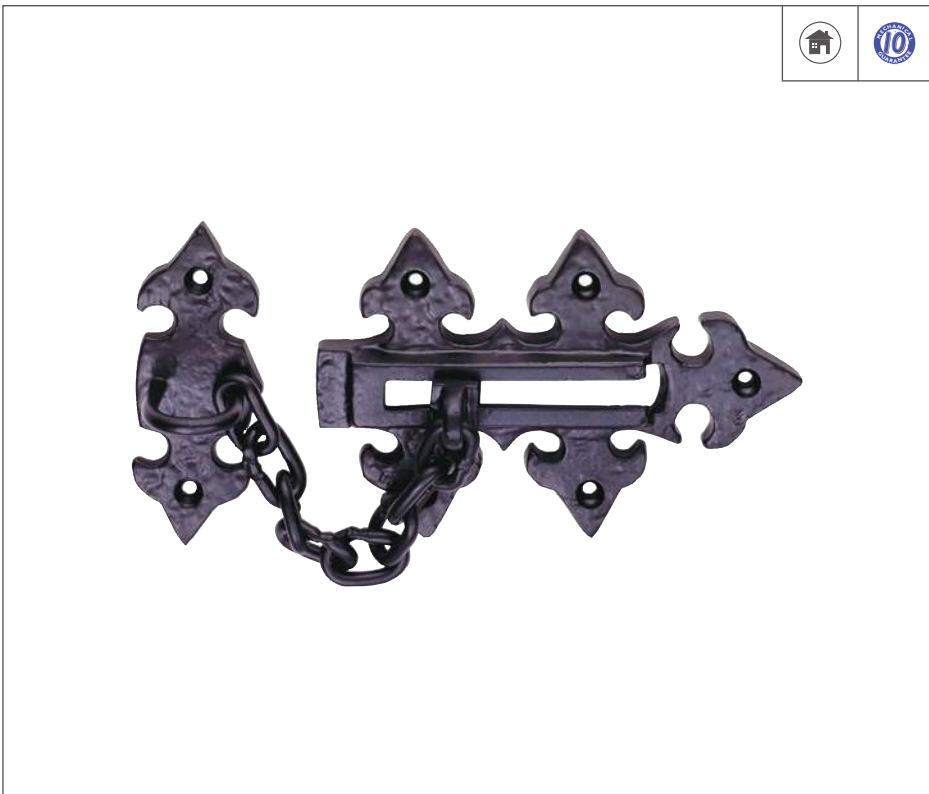

LF5536

DOOR CHAIN

Dimensions (mm):

Overall: 132x82



LUDLOW BLACK ANTIQUE



LF5591

ORNATE DOOR KNOCKER

Dimensions (mm):

Overall: 210x79



LF5592

DOOR KNOCKER



Dimensions (mm):

Overall: 196x81



LUDLOW BLACK ANTIQUE



LF55495

NUMERAL Face Fix

Dimensions (mm):
Height: 78

Variations:

LF55490 Numeral 0	LF55495 Numeral 5
LF55491 Numeral 1	LF55496 Numeral 6/9
LF55492 Numeral 2	LF55498 Numeral 7
LF55493 Numeral 3	LF55498 Numeral 8
LF55494 Numeral 4	

 **BA**









LF55102

DOOR STUD

Dimensions (mm):
Overall: 15x15

 **BA**





LF55103



DOOR STUD LARGE

Dimensions (mm):
Overall: 23x23

 **BA**

LUDLOW BLACK ANTIQUE









LF5590

RING DOOR KNOCKER

Dimensions (mm):
 Ring: 94 Outer Dia.

BA



LF5544A

BULB END CASEMENT STAY



Dimensions (mm):
 Length: 203

Variations:

LF5544B	254
LF5544C	305

BA



LF5545

BULB END CASEMENT FASTENER

Dimensions (mm):
 Backplate: 60x21



BA

LF5545 not suitable for weather stripped windows.



LUDLOW BLACK ANTIQUE







LF1006LH



LOCKING CASEMENT FASTENER Left Hand

Dimensions (mm):
Backplate: 57x20

Variations:
LF1006RH Right Hand

 BA







LF34LH



LOCKING ESPAGNOLETTE FASTENER Left Hand

Dimensions (mm):
Backplate: 58x27

Variations:
LF34RH Right Hand

 BA







LF5537





CASEMENT FASTENER





Dimensions (mm):
Backplate: 60x22

 BA

LUDLOW BLACK ANTIQUE

	 	<p>LF5540A</p> <p>CASEMENT STAY</p> <p>Dimensions (mm): Length: 203</p> <p>Variations: LF5540B 254 LF5540C 305</p> <p> BA</p>
-----------------------------------------------------------------------------------	----------------------------------------------------------------------------------------------------------------------------------------------------------------------	-------------------------------------------------------------------------------------------------------------------------------------------------------------------------------------------------------------------------------------------------------------------------------------------------------------

	 	<p>LF5542</p> <p>CURLY TAIL CASEMENT FASTENER</p> <p>Dimensions (mm): Overall Length: 125 Width: 80</p> <p> BA</p>
------------------------------------------------------------------------------------	----------------------------------------------------------------------------------------------------------------------------------------------------------------------	------------------------------------------------------------------------------------------------------------------------------------------------------------------------------------------------------------------------------------------------------------------------

	 	<p>LF5541A</p> <p>CURLY TAIL CASEMENT STAY</p> <p>Dimensions (mm): Length: 203</p> <p>Variations: LF5541B 254 LF5541C 305</p> <p> BA</p>
-------------------------------------------------------------------------------------	--------------------------------------------------------------------------------------------------------------------------------------------------------------------------	--------------------------------------------------------------------------------------------------------------------------------------------------------------------------------------------------------------------------------------------------------------------------------------------------------------------------

LF5542 not suitable for weather stripped windows.



LUDLOW BLACK ANTIQUE



LF5101

**BARLEY TWIST PULL
HANDLE ON BACKPLATE**

Dimensions (mm):

Backplate: 310x66
Projection: 82

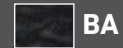

BA

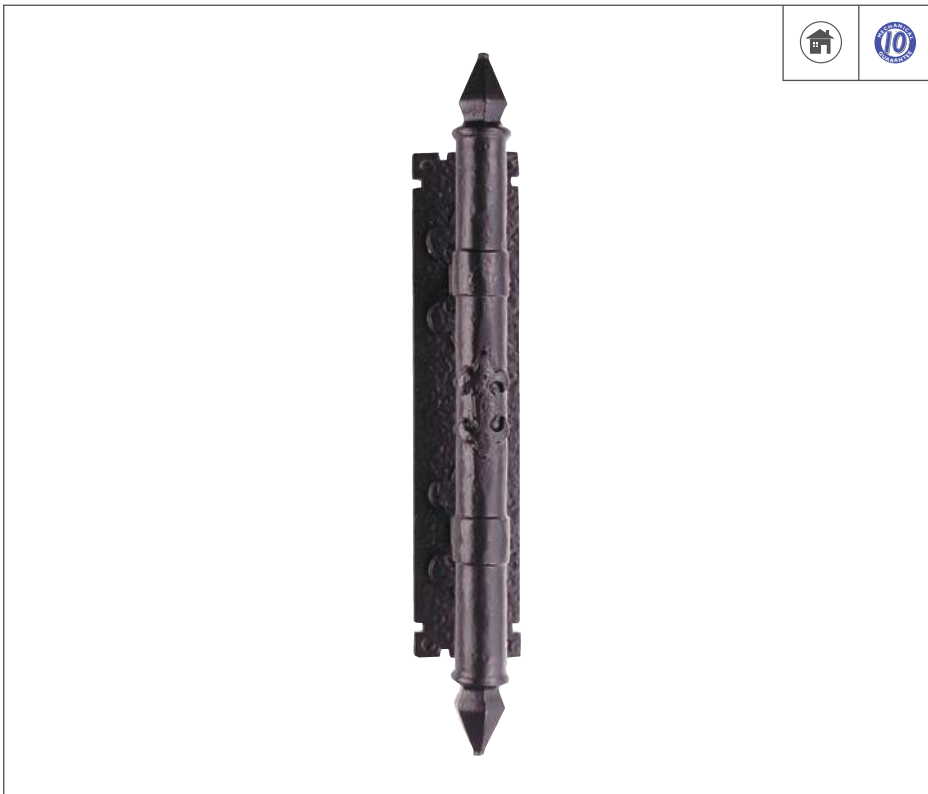

LF5103

**ARMORIAL PULL HANDLE
ON BACKPLATE**





Dimensions (mm):





Backplate: 314x67
Projection: 78
Overall Length: 415



BA

LUDLOW BLACK ANTIQUE

	 	LF5260LH
	ARMORIAL PULL HANDLE ON BACKPLATE Left Hand Dimensions (mm): 263x46 Variations: LF5260RH Right Hand	
		 BA

	 	LF5575A
	HOTBED HANDLE Dimensions (mm): Length: 133 Variations: LF5575B 153	
		 BA

LUDLOW BLACK ANTIQUE

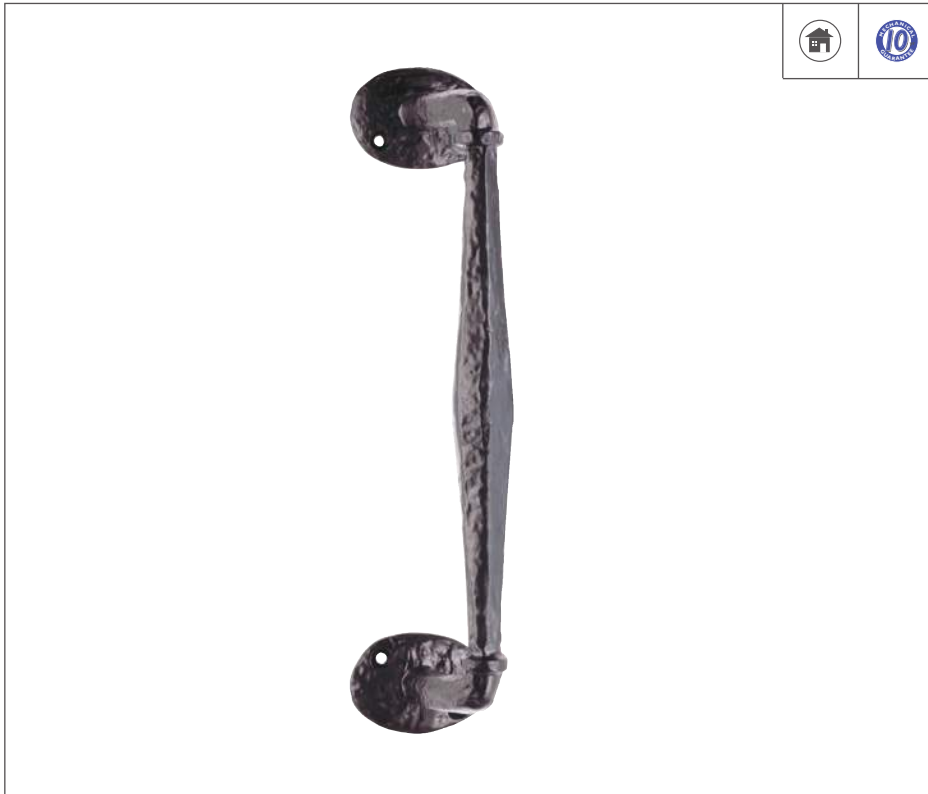

LF5266

**OFFSET PULL HANDLE
ON ROSE**

Dimensions (mm):

Length: 239

 **BA**

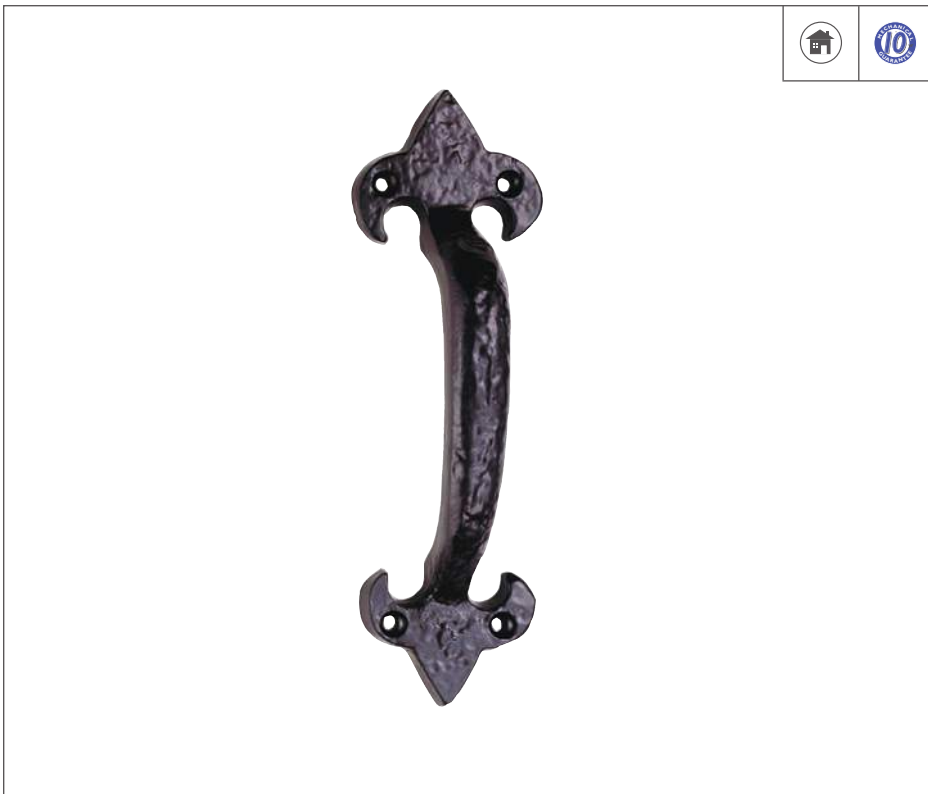

LF5574A

PULL HANDLE

Dimensions (mm):

Length: 133

Variations:

LF5574B 178

LF5574C 228

 **BA**

LUDLOW BLACK ANTIQUE



LF55101

FINGERPLATE

Dimensions (mm):

Overall: 315x67



BA



LF5102

ARMORIAL FINGER PLATE

Dimensions (mm):

Overall: 315x67





BA



LUDLOW BLACK ANTIQUE



 

LF5535



THUMB LATCH SET

Dimensions (mm):

Handle:	194
Latch:	140

 **BA**



 

LF5526

HAT AND COAT HOOK

Dimensions (mm):

Height:	138
Projection:	92

 **BA**

LUDLOW BLACK ANTIQUE





LF5530A

STRAIGHT DOOR BOLT
c/w staple and plate

Dimensions (mm):
Length: 108

Variations:
LF5530B 152
LF5530C 199

 BA







LF5563A



CRANKED DOOR BOLT

Dimensions (mm):
Length 115

Variations:
LF5563B 157
LF5563C 214

 BA







LF5528C

CABIN HOOK

Dimensions (mm):
Length 203

Variations:
LF5528A 102
LF5528B 152
LF5528D 305

 BA

LUDLOW BLACK ANTIQUE

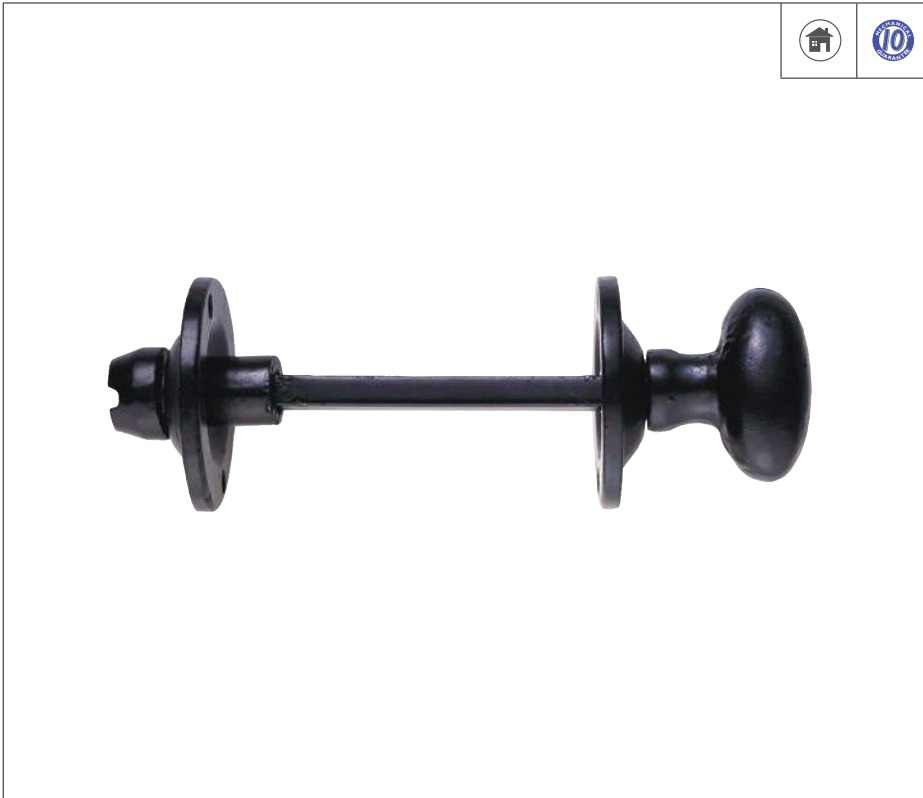

AA133BA

**OVAL THUMBTURN AND
RELEASE**

Dimensions (mm):

Rose: 38 Dia.
Spindle: 4.9

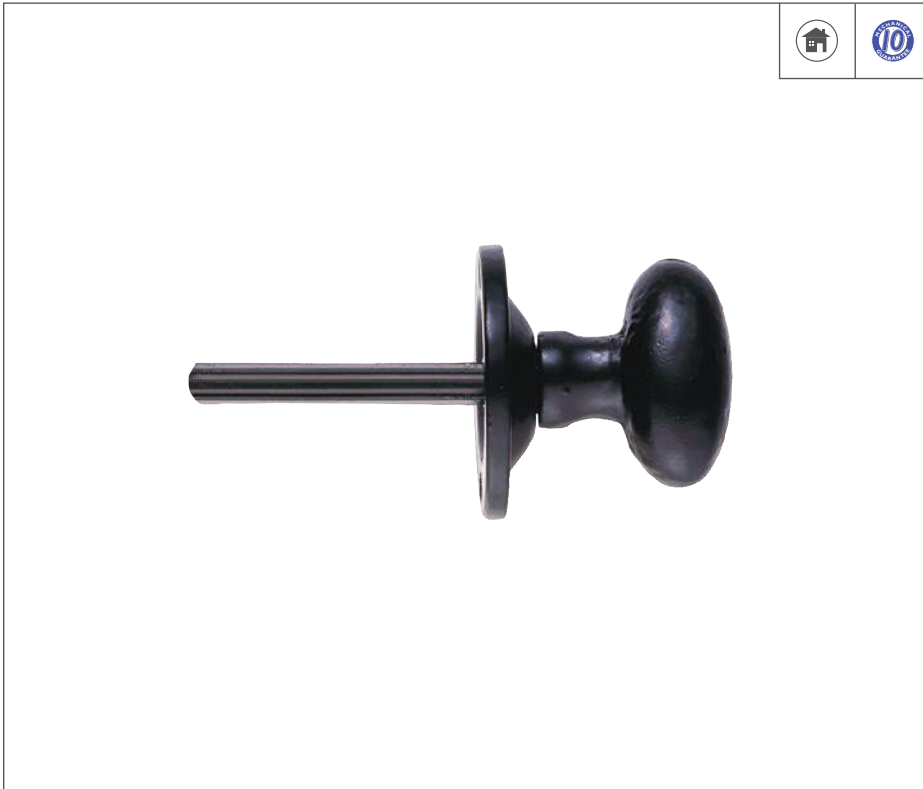

AA33BA

OVAL THUMBTURN





Spline spindle to operate rack bolt

Dimensions (mm):





Rose: 40 Dia.



LUDLOW BLACK ANTIQUE



	 	LF5130
		<p>PROJECTION DOOR STOP</p> <p>Dimensions (mm): Height: 75</p> <p> BA</p>

	 	HINFP1PCB
		<p>HINGE FIXED PIN c/w screws</p> <p>Dimensions (mm): Overall: 76x51</p> <p>Variations: HINFP4PCB 102x67</p> <p> PCB</p>

	 	LF5527
		<p>SINGLE WARDROBE HOOK</p> <p>Dimensions (mm): 60</p> <p> BA</p>

LUDLOW BLACK ANTIQUE







LF5515A



TEE HINGE

Dimensions (mm):
Overall: 408x103

Variations:
LF5515 305x103
LF5515B 461x103

 **BA**







LF5121



SWORD HINGE FRONT

Dimensions (mm):
Overall: 306x139

Variations:
LF5122 383x147
LF5123B 463x158

 **BA**







LF5519A

SWORD HINGE



Dimensions (mm):
Length: 348

Variations:
LF5519B 422
LF5519C 503

 **BA**

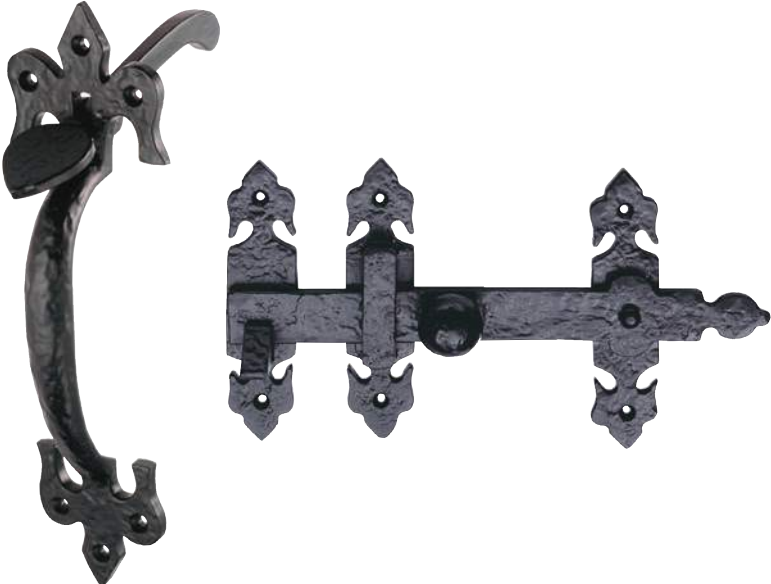
LUDLOW BLACK ANTIQUE



LF5548

SUFFOLK LATCH



Dimensions (mm):

Length:	234
Latch:	188

Back of handle to end of lever approx 76mm

BA







LF5547

RING HANDLE GATE LATCH

Dimensions (mm):

Overall:	190x114
----------	---------

BA

Hand Forged Beeswax Range



LUDLOW BEESWAX



BW5501

TUDOR

Lever on Lock Backplate

Dimensions (mm):

Backplate: 266x43
 Projection: 66
 Lever Length: 140

Variations:

BW5502 Latch
BW5503 Bathroom



BW5504

GOTHIC

Lever on Lock Backplate

Dimensions (mm):

Backplate: 251x43
 Projection: 66
 Lever Length: 120



Variations:

BW5505 Latch
BW5506 Bathroom



LUDLOW BEESWAX



BW5515A

BEAN T HINGE



Dimensions (mm):
Overall Length: 110

Variations:

BW5515B	154
BW5515C	304
BW5515D	390
BW5515E	460

 **BW**



BW5520A

ARROW HEAD T HINGE

Dimensions (mm):
Overall Length: 115

Variations:

BW5520B	166
BW5520C	309
BW5520D	393
BW5520E	460

 **BW**

LUDLOW BEESWAX



BW5535

BEAN THUMBLATCH HANDLE

Dimensions (mm):

Overall: 210x190

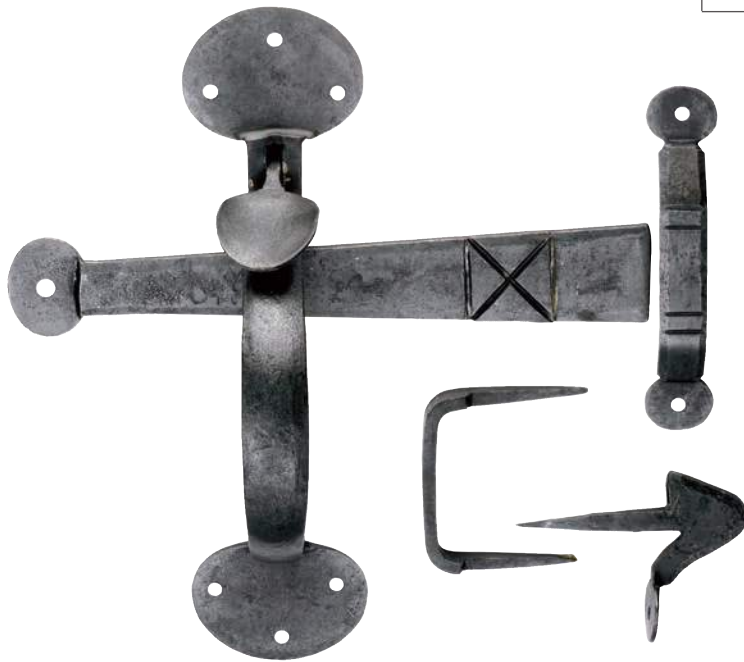

BW5545

GOTHIC THUMBLATCH HANDLE

Dimensions (mm):

Overall: 217x190



LUDLOW BEESWAX

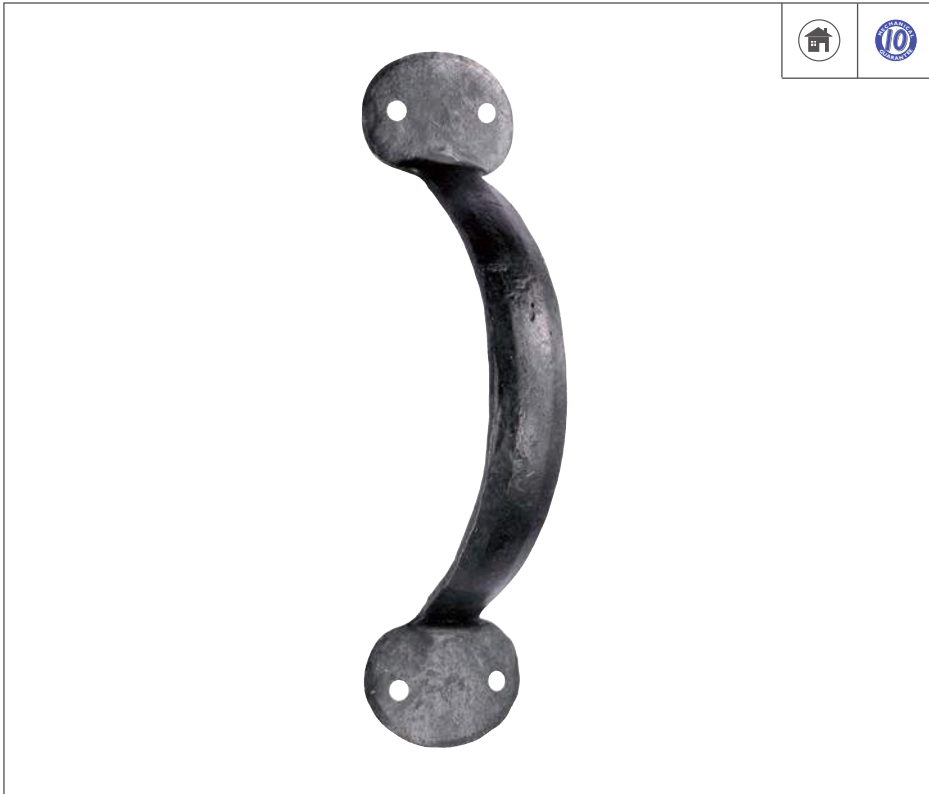

BW5574A

BEAN D HANDLE

Dimensions (mm):
Overall Length: 99

Variations:

BW5574B	150
BW5574C	194

 **BW**



BW5584A

GOTHIC D HANDLE

Dimensions (mm):
Overall Length: 107

Variations:

BW5584B	144
BW5584C	188

 **BW**

LUDLOW BEESWAX



BW5564A

FISHTAIL STRAIGHT BOLT

Dimensions (mm):

Overall Length: 108

Variations:

BW5564B 170



BW5565A

FISHTAIL CRANKED BOLT

Dimensions (mm):

Overall Length: 108



Variations:

BW5565B 170



LUDLOW BEESWAX



BW5530A



**SHEPHERDS CROOK
STRAIGHT BOLT**

Dimensions (mm):
Overall Length: 105

Variations:
BW5530B 175

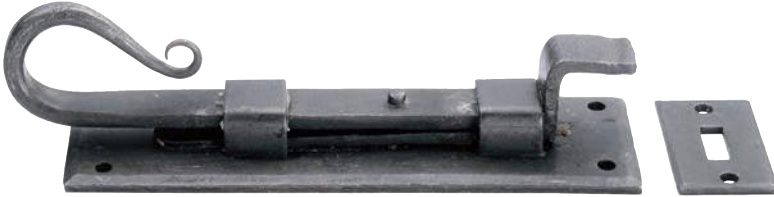
BW



BW5563A

**SHEPHERDS CROOK
CRANKED BOLT**

Dimensions (mm):
Overall Length: 105

Variations:
BW5563B 175

BW

LUDLOW BEESWAX



BW5527

**GOTHIC SINGLE ROBE
HOOK**

Dimensions (mm):

Overall: 128x59



BW5528

**BEAN SINGLE ROBE
HOOK**

Dimensions (mm):

Overall: 97x54



LUDLOW BEESWAX

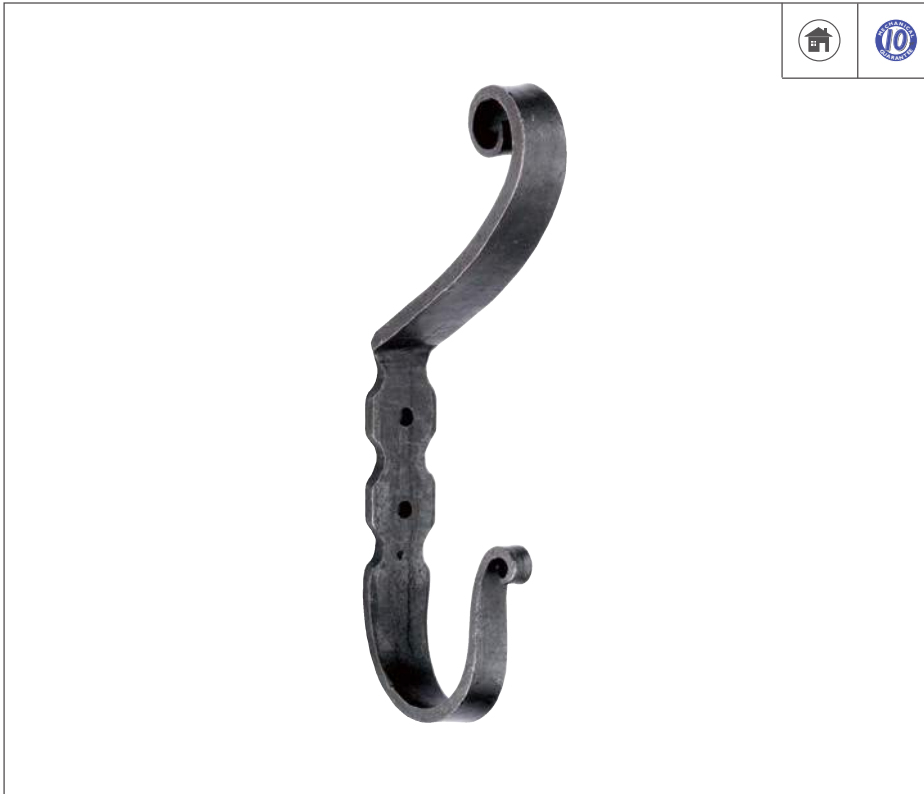

BW5526

HAT AND COAT HOOK FORGED

Dimensions (mm):
Overall: 149x19

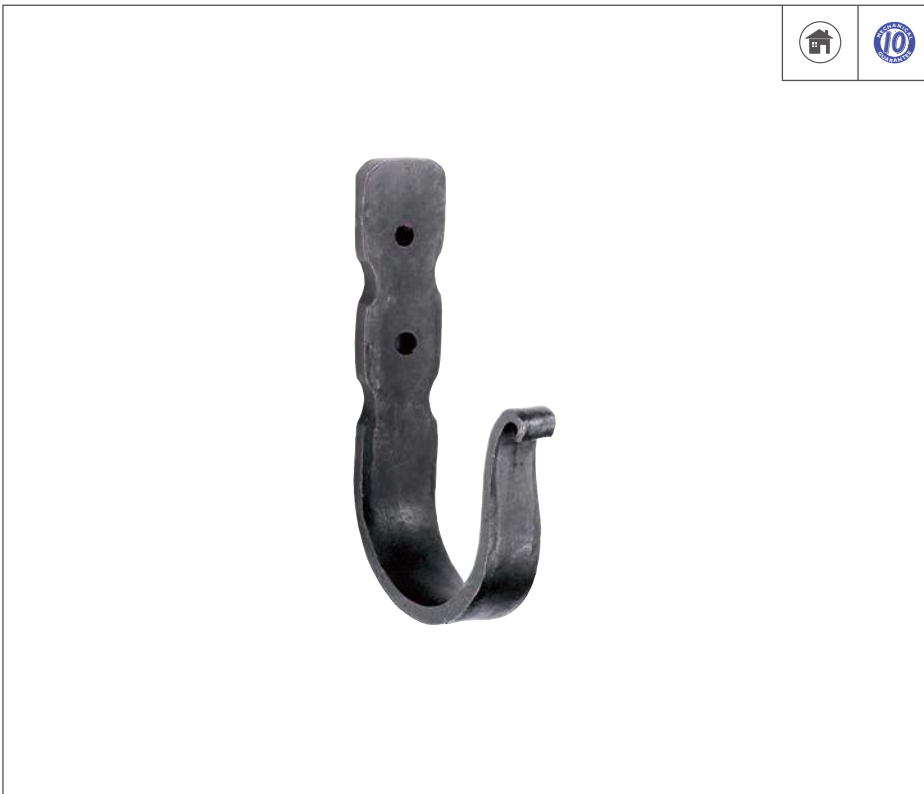

BW5529

ROBE HOOK FORGED

Dimensions (mm):
Overall: 89x20



LUDLOW BEESWAX



BW1078A

BEATEN CUPBOARD KNOB

Dimensions (mm):

Overall Width: 20

Variations:

BW1078B 30

BW1078C 40



BW



BW34LH

MONKEY TAIL LOCKING FASTENER Left Hand

Dimensions (mm):

Length: 120

Variations:



BW34RH Right Hand



BW

LUDLOW BEESWAX







BW5541A



MONKEY TAIL STAY

Dimensions (mm):
Overall Length: 203

Variations:
BW5541B 254
BW5541C 305

 BW







BW1006RH



SHEPHERDS CROOK LOCKING CASEMENT FASTENER Right Hand

Dimensions (mm):
Length: 127

Variations:
BW1006LH Left Hand

 BW







BW5540A

SHEPHERDS CROOK STAY

Dimensions (mm):
Length: 203

Variations:
BW5540B 254
BW5540C 305

 BW

LUDLOW BEESWAX



BW5594



HAMMER HEAD MORTICE KNOB

Dimensions (mm):

Knob: 67x32
 Rose: 61 Dia.
 Projection: 65



BW



BW55460



**ESCUTCHEON Lock
 OPEN AND CLOSED**

Dimensions (mm): Dia. 40

Variations:
BW5546C Dia. 40



BW

Hand Forged Pewter Effect Range



LUDLOW PEWTER

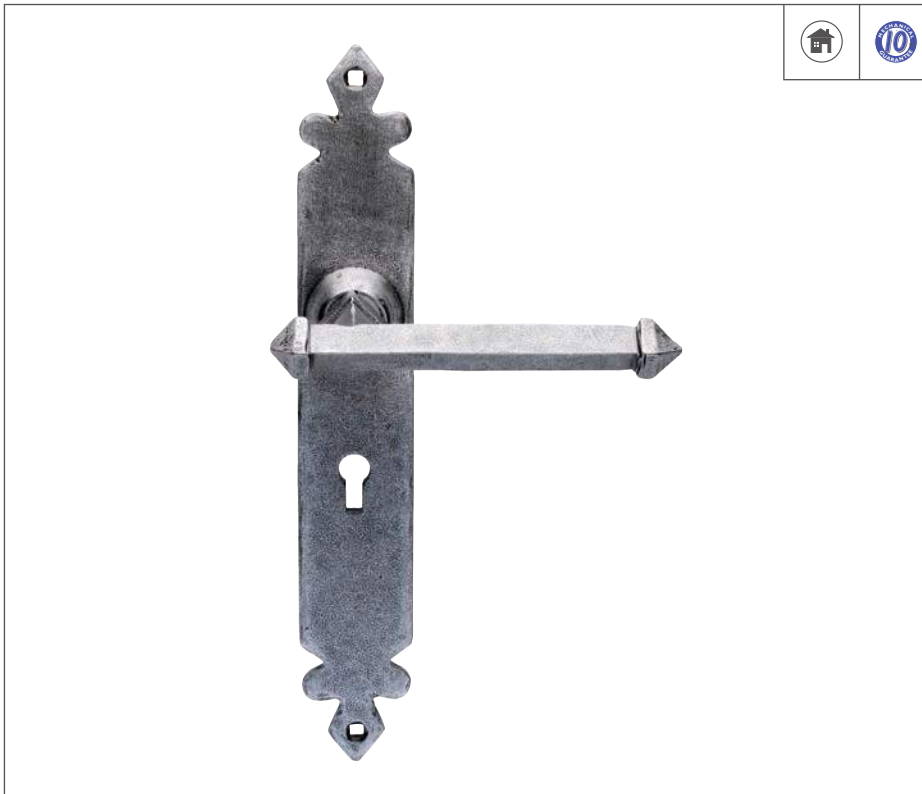

PE5501

TUDOR

Lever on Lock Backplate

Dimensions (mm):

Backplate: 266x43
 Projection: 66
 Lever Length: 140

Variations:

PE5502 Latch
PE5503 Bathroom

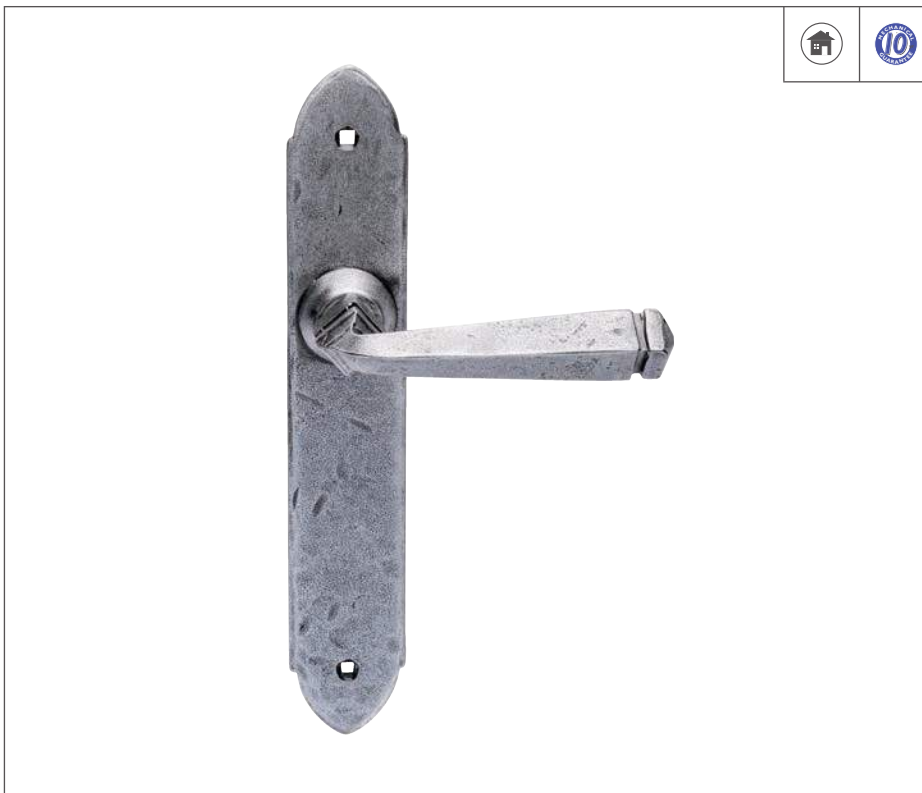

PE5504

GOTHIC

Lever on Lock Backplate

Dimensions (mm):

Backplate: 251x43
 Projection: 66
 Lever Length: 120

Variations:

PE5505 Latch
PE5506 Bathroom



LUDLOW PEWTER

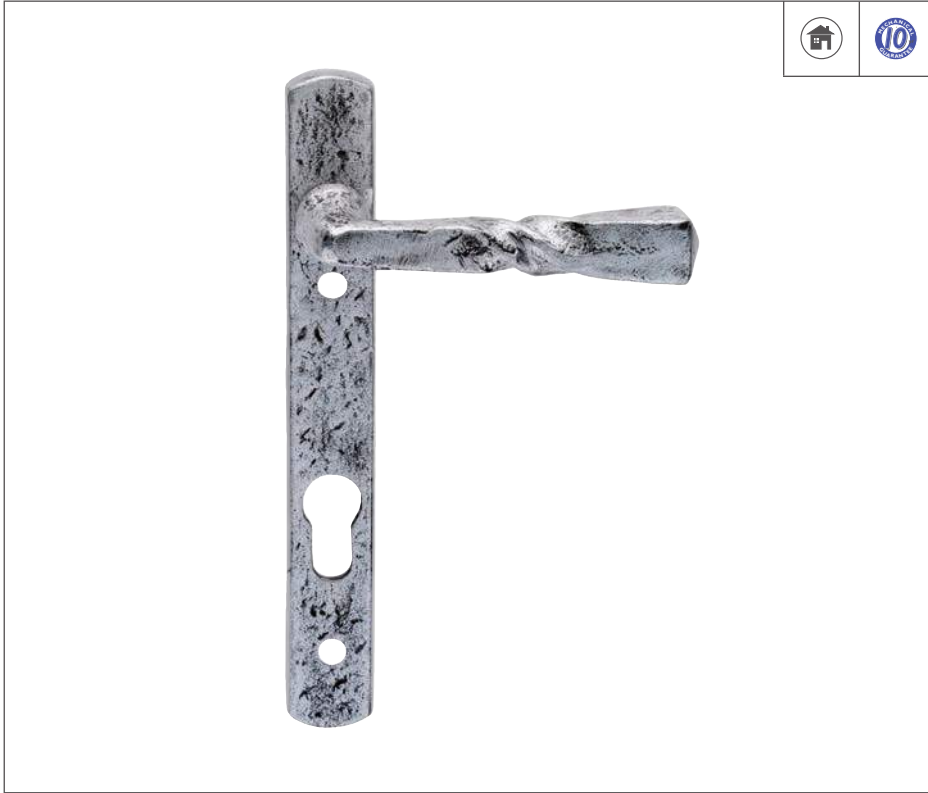

PE56NP92

NARROW PLATE

Lever on Lock Backplate Unsprung

Dimensions (mm):

Backplate:	218x30
Projection:	60
Lever Length:	120
Centres:	92



PE5520B

ARROW HEAD T HINGE

Dimensions (mm):

Overall Length:	166
-----------------	-----

Variations:

PE5520D	393
PE5520E	460



LUDLOW PEWTER

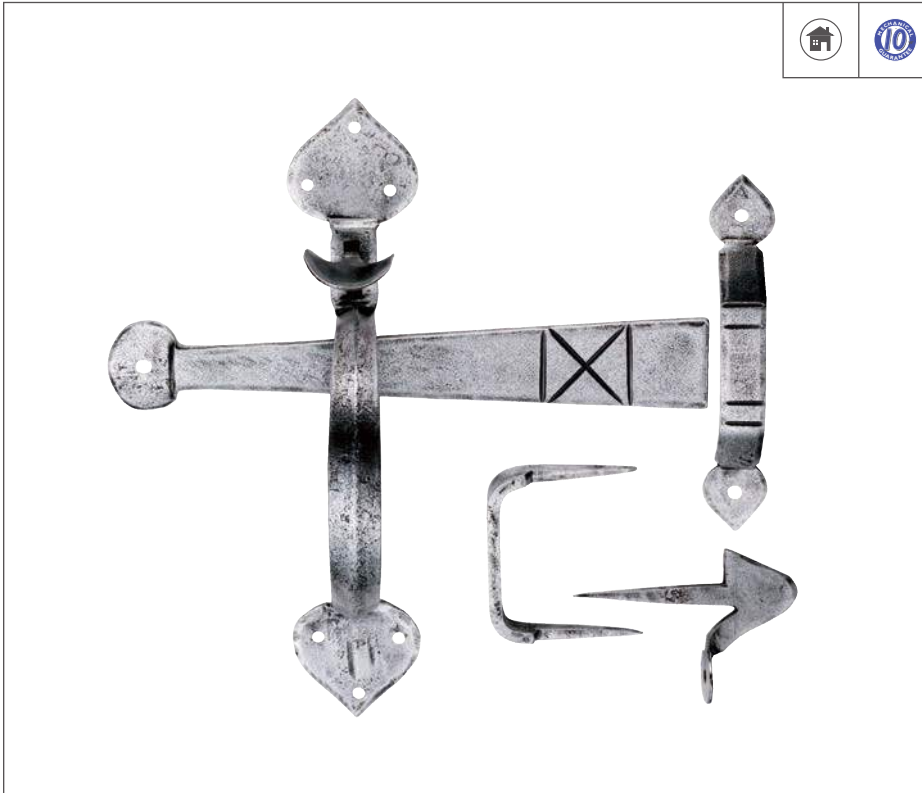

PE5535

GOTHIC THUMBLATCH

Dimensions (mm):

Overall: 210x190

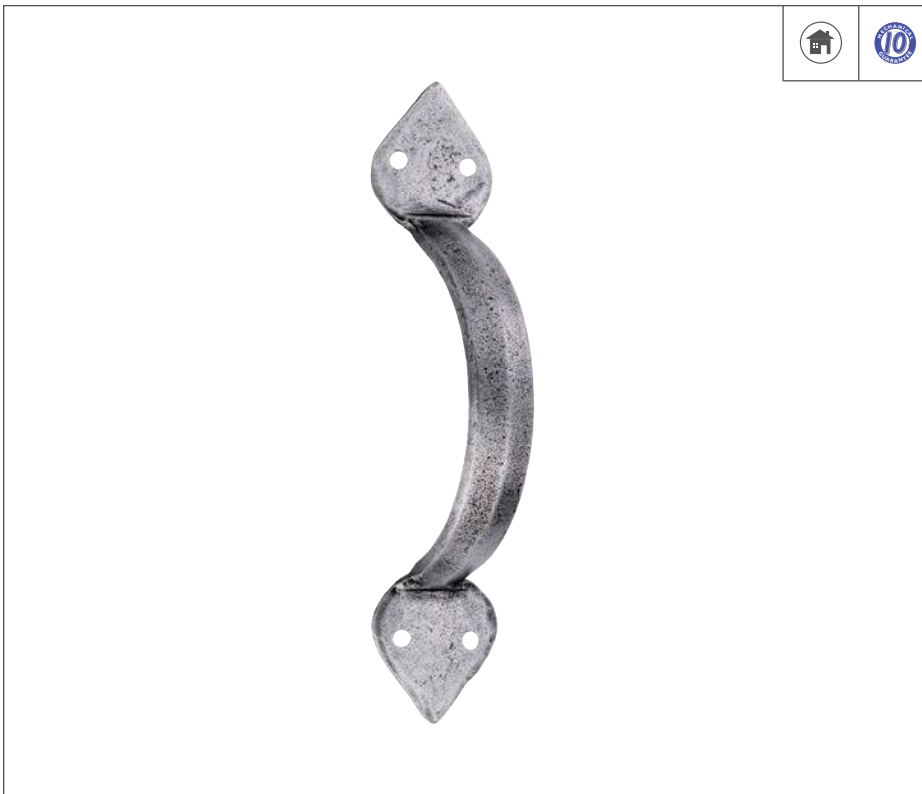

PE5584A

GOTHIC D HANDLE

Dimensions (mm):

Length: 107

Variations:

PE5584B 144

PE5584C 188



LUDLOW PEWTER



PE5564A

FISHTAIL STRAIGHT BOLT

Dimensions (mm):
Length: 108

Variations:
PE5564B 170



PE5565A

FISHTAIL CRANKED BOLT

Dimensions (mm):
Length: 108

Variations:
PE5565B 170



LUDLOW PEWTER



PE5530A

**SHEPHERDS CROOK
STRAIGHT BOLT**

Dimensions (mm):

Length: 105

Variations:

PE5530B 175



PE



PE5563A

**SHEPHERDS CROOK
CRANKED BOLT**

Dimensions (mm):

Length: 105

Variations:

PE5563B 175



PE

LUDLOW PEWTER



PE1078A

CUPBOARD KNOB

Dimensions (mm):
Overall Width: 20

Variations:
PE1078B 30
PE1078C 40

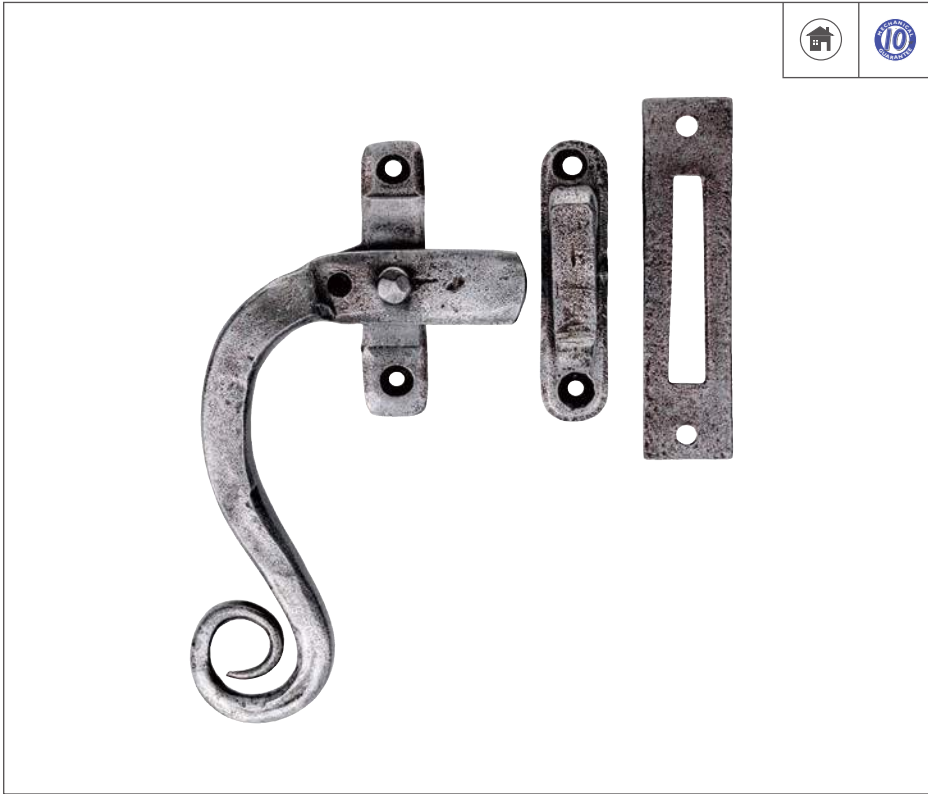

PE34LH

MONKEYTAIL LOCKING FASTENER Left Hand

Dimensions (mm):
Length: 120

Variations:
PE34RH Right Hand



LUDLOW PEWTER



PE5541A



MONKEY TAIL STAY

Dimensions (mm):
Overall Length: 203

Variations:
PE5541B 254
PE5541C 305



PE1006RH



**SHEPHERDS CROOK
LOCKING FASTENER Right Hand**

Dimensions (mm):
Length: 127

Variations:
PE1006LH Left Hand



PE5540A



SHEPHERDS CROOK STAY

Dimensions (mm):
Length: 203

Variations:
PE5540B 254
PE5540C 305



LUDLOW PEWTER





	 	PE5634
		TUDOR BELL PUSH Dimensions (mm): Overall: 118x30
		 PE

	 	PE5654
		GOTHIC BELL PUSH Dimensions (mm): Overall: 118x30
		 PE

LUDLOW PEWTER

	 	<p>PE5524</p>
	<p>LETTER PLATE</p> <p>Dimensions (mm): Overall: 280x101</p> <p> PE</p>	

	 	<p>PE55</p>
	<p>LETTER TIDY</p> <p>Dimensions (mm): Overall: 295x107</p> <p> PE</p>	

	 	<p>PE55460</p>
	<p>ESCUTCHEON Lock OPEN AND CLOSED</p> <p>Dimensions (mm): Dia. 40</p> <p>Variations: PE5546C Dia. 40</p> <p> PE</p>	

LUDLOW PEWTER

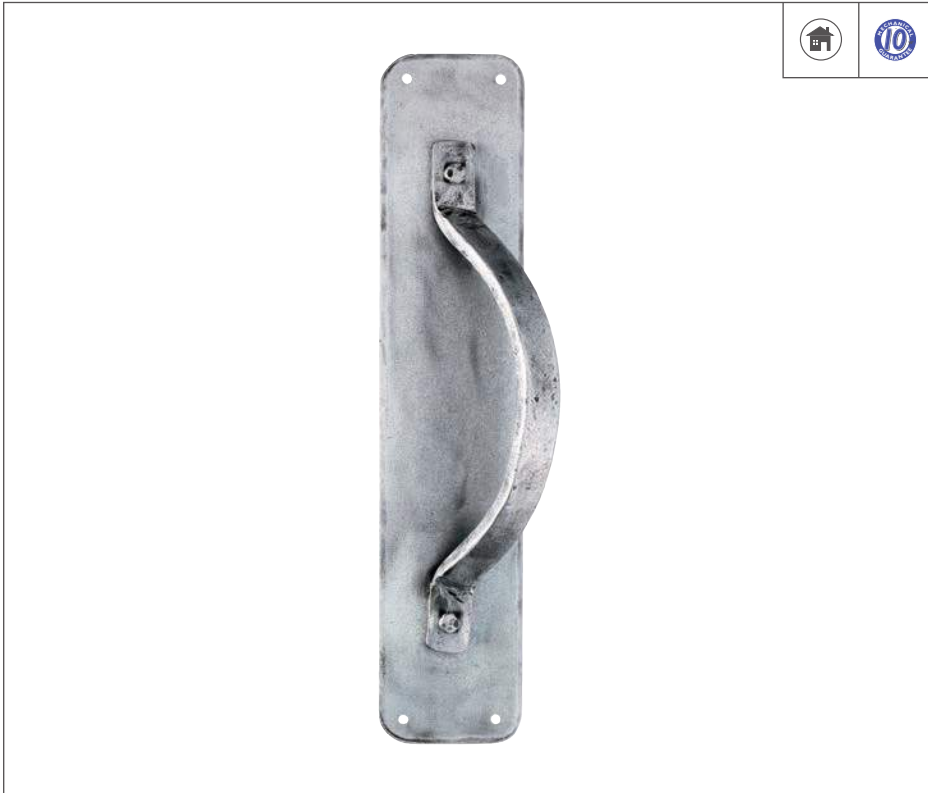

PE5574

PULL HANDLE ON PLATE

Dimensions (mm):

Overall: 315x65
Projection: 52

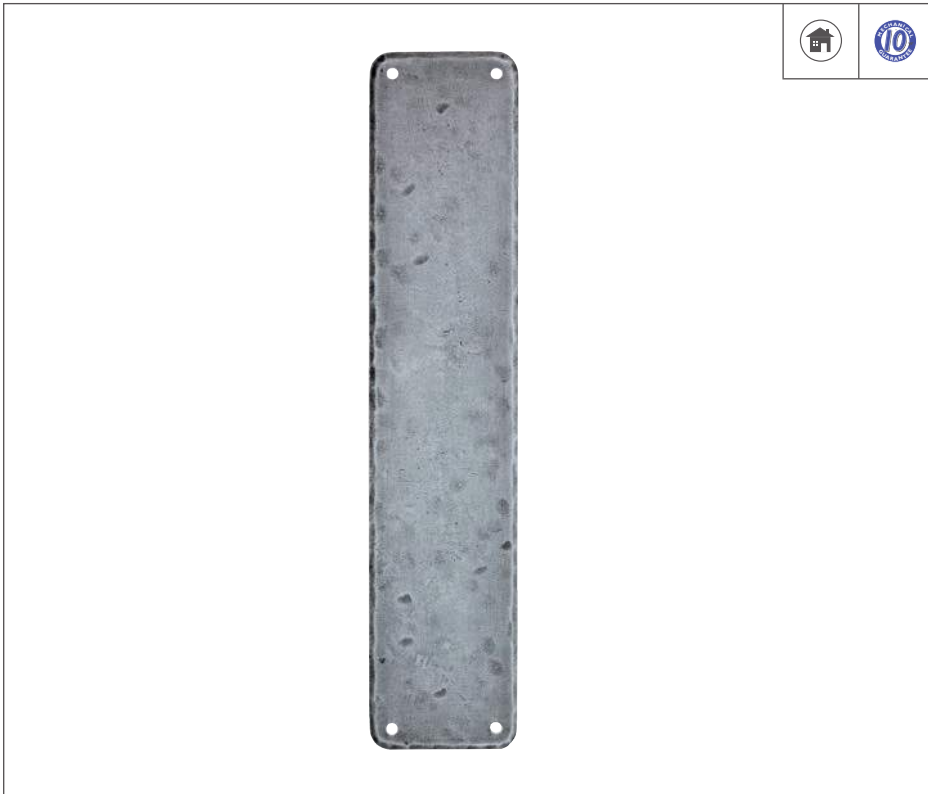

PE55101

PUSH PLATE

Dimensions (mm):

Overall: 315x65



LUDLOW PEWTER



PE5550

CENTRE DOOR KNOB

Dimensions (mm):

Knob:	75 Dia.
Rose:	75 Dia.
Projection:	56



PE



PE56495

NUMERAL Face Fix

Dimensions (mm):

Height:	78
---------	----

Variations:

PE56490	Numeral 0
PE56491	Numeral 1
PE56492	Numeral 2
PE56493	Numeral 3
PE56494	Numeral 4
PE56495	Numeral 5
PE56496/9	Numeral 6 or 9
PE56497	Numeral 7
PE56498	Numeral 8



PE

LUDLOW PEWTER



PE5590

WEALDEN DOOR KNOCKER

Dimensions (mm):

Overall: 186x141



PE



HINGES



183876

**CONTRACTORS
NARROW PATTERN
BUTT HINGE**

Dimensions (mm):

Length: 76
Width: 50
Depth: 1.5

Variations:

1838100 102x70x2

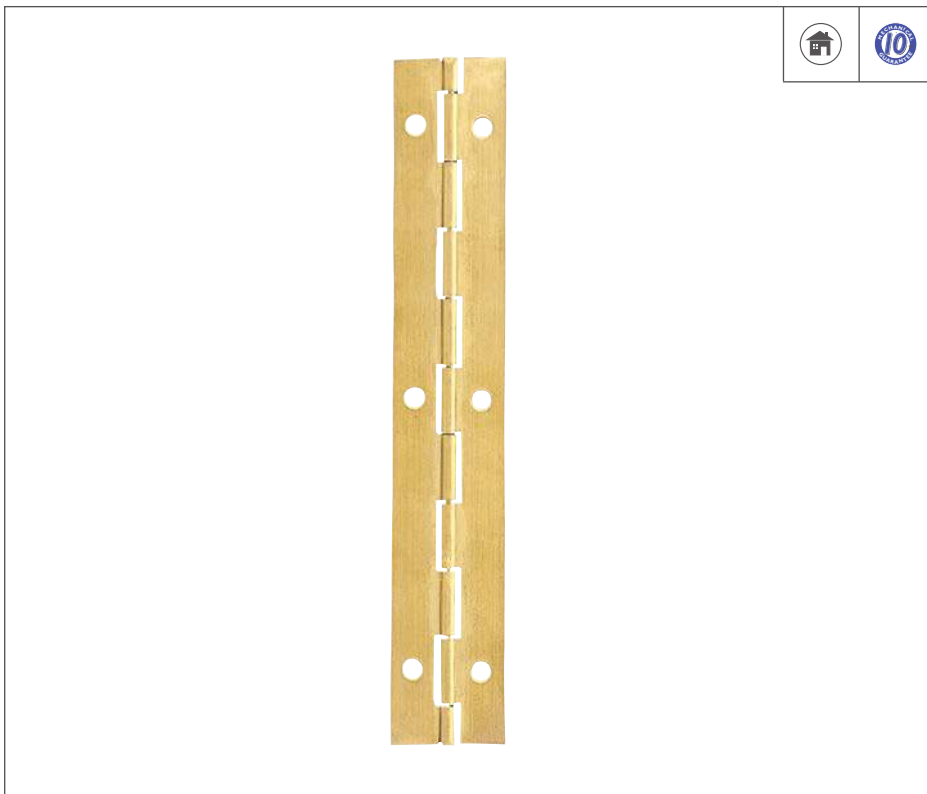

EBH1/20

PLATED STEEL PIANO HINGE

Dimensions (mm):

Length: 1829
Width: 25
Depth: 1

Finish Variations:

EBH2/20 EB 1829x32x1
EBH3/20 EB 1829x38x1
FBH1/20 FB 1829x25x1
FBH2/20 FB 1829x32x1
NPH1/20 NP 1829x25x1
NPH2/20 NP 1829x32x1
NPH3/20 NP 1829x38x1



All piano hinges available in multiples of 20 only. Spare screws available.
Also available in hanging bags - A full range of hinges for the building trade. Flush, rising butt, 1838, 451 strong, security, loose pin and parliament.

HINGES



HINLP1

LOOSE PIN HINGE

Dimensions (mm):

Length:	76
Width:	50
Depth:	1.6

Variations:

HINLP4	102x67x2
---------------	----------



HINFP1

FIXED PIN HINGE

Dimensions (mm):

Length:	76
Width:	50
Depth:	1.6

Variations:

HINFP4	102x67x2
---------------	----------



HINLP4 not available in W finish.



HINGES



HSD3

SOLID DRAWN BRASS BUTT HINGE

Dimensions (mm):

Length: 70
 Width: 40
 Depth: 1.5

Variations:

HSD4 102x60x2



SB



HDPBW21

DOUBLE PHOSPHOR BRONZE WASHERED BUTT HINGE

Dimensions (mm):

Length: 76
 Width: 50
 Depth: 2.5

Variations:

HDPBW4 102x67x2.5

HDPBW61 102x67x4

HDPBW8 102x76x4

HDPBW10 127x76x3



FB



POL/LAC



HDPBW4, HDPBW8 and HDPBW10 not available in FB finish.



HDSW1



DOUBLE STEEL WASHERED BRASS BUTT HINGE

Dimensions (mm):

Length:	76
Width:	50
Depth:	2

Variations:

HDSW2	102x67x2.2
HDSW20	76x50x2.5
HDSW3	102x67x2.5
HDSW4	102x67x2.5
HDSW9	127x76x3



HDSSW2



DOUBLE STAINLESS STEEL WASHERED BRASS BUTT HINGE

Dimensions (mm):

Length:	76
Width:	50
Depth:	2.5

Variations:

HDSSW5	102x67x4
---------------	----------



HDSW1/HDSW2 not available in SB finish. HDSW20/HDSW3 not available in CP or POL/LAC finishes. HDSW4 not available in CP or SB finishes. HDSW9 not available in CP or POL/LAC finishes.



HINGES



HDBB1

DOUBLE BALL BEARING HINGE

Dimensions (mm):

Length: 102
 Width: 76
 Depth: 3

Variations:

HDBB3 76x50x2

 **POL/LAC**



HDBB4

GRADE 13 DOUBLE BALL BEARING HINGE

Dimensions (mm):

Length: 102
 Width: 76
 Depth: 3

 **BEP**  **EB**  **FB**



RBH1433

RISING BUTT HINGE

Dimensions (mm):

Length:	102
Width:	75
Depth:	3

Variations:

RBH1433LEF	Left Hand
RBH1433RIG	Right Hand



SSS



HIN1322

BALL BEARING HINGE

Dimensions (mm):

Length:	76
Width:	51
Depth:	2





BSS

PVD

SSS

HINGES



HIP1332



PLAIN HINGE

Dimensions (mm):

Length:	76
Width:	76
Depth:	2

BSS
 SSS



HIP14325

PLAIN HINGE

Dimensions (mm):

Length:	100
Width:	76
Depth:	2.5

BSS
 SSS



HIW13215

WASHERED HINGE

Dimensions (mm):

Length:	76
Width:	51
Depth:	1.5



BSS SSS



HIW14325

WASHERED HINGE

Dimensions (mm):

Length:	102
Width:	76
Depth:	2.5



BSS SSS

HINGES



HIN3424

PARLIAMENT HINGE

Dimensions (mm):

Length:	102
Width:	102
Depth:	4



HIP13225/7

**GRADE 7
PLAIN BEARING HINGE**

Dimensions (mm):

Length:	76
Width:	67
Depth:	2.5
Maximum Loading:	40kg

Variations:

HIP14325/7	100x76x2.5
-------------------	------------

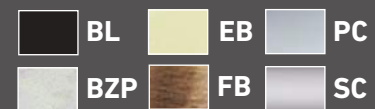

ENDURO® HINGES



HIN13225/11R

**GRADE 11
BALL BEARING HINGE** Radius

Dimensions (mm):

Length: 76
Width: 67
Depth: 2.5
Maximum Loading: 80kg

Variations:

HIN13225/11 Square



HIN1433/13

**GRADE 13
BALL BEARING HINGE**

Dimensions (mm):

Length: 102
Width: 76
Depth: 3
Maximum Loading: 120kg

Variations:

HIN1433/13R Radius

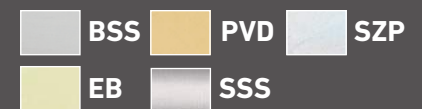

HIN1433/13/SSS also available in pack of 3 HIN1433/13SSS/3P.
Intumescent hinge liners INT1102-1143 available to suit 1/2 hour and 1 hour fire doors see P319.
For 1 hour requirement please use 2 packs.

ENDURO® HINGES



HIN1433P/13



GRADE 13 PLAIN BALL BEARING HINGE

Dimensions (mm):
 Length: 102
 Width: 76
 Depth: 3
 Maximum Loading: 120kg

Variations:
 HIN1433P/13R Radius
 HIN1443P 102x102x3

BSS SSS



HIN14325/13R



GRADE 13 BALL BEARING HINGE Radius

Dimensions (mm):
 Length: 102
 Width: 76
 Depth: 2.5
 Maximum Loading: 120kg

Variations:
 HIN14325/13 Square

BSS PVD SSS

ENDURO® HINGES



CEN1433/13

**GRADE 13
BALL BEARING HINGE
GRADE 316**

Dimensions (mm):

Length:	102
Width:	76
Depth:	3
Maximum Loading:	120kg

Variations:

CEN1433/13/R	Radius
CEN1443/13	102x102x3
CEN1443/13/R	102x102x3 Radius



SCH14325/13

**GRADE 13
SLIM KNUCKLE HINGE
10mm Dia. Narrow Knuckle**

Dimensions (mm):

Length:	102
Width:	76
Depth:	2.5
Maximum Loading:	120kg

Variations:

SCH14325/13/R	Radius
----------------------	--------



Intumescent hinge liners INT1102-1143 available to suit 1/2 hour and 1 hour fire doors see P319.
For 1 hour requirement please use 2 packs.

ENDURO® HINGES



HIN1433SEC/13



GRADE 13 BALL BEARING SECURITY HINGE

Dimensions (mm):
 Length: 102
 Width: 76
 Depth: 3
 Maximum Loading: 120kg

Variations:
 HIN1433SEC/13/R Radius



HIN1433HT/13



GRADE 13 BALL BEARING HOSPITAL TIP HINGE
 TS001 November 2005

Dimensions (mm):
 Length: 102
 Width: 76
 Depth: 3
 Maximum Loading: 120kg



ENDUROMAX® HINGES



H2N1202/11/R

**GRADE 11 LIFT OFF
THRUST BEARING HINGE** Radius

Dimensions (mm):

Length:	100
Width:	89
Depth:	3
Maximum Loading:	80kg

Variations:

- H2N1202/11/R/LEF** Left Hand
- H2N1202/11/R/RIG** Right Hand



H2N1503/11/R

**GRADE 11 LIFT OFF
THRUST BEARING HINGE** Radius

Dimensions (mm):

Length:	98
Width:	83
Depth:	3
Maximum Loading:	80kg

Variations:

- H2N1503/11/R/LEF** Left Hand
- H2N1503/11/R/RIG** Right Hand



Intumescent hinge liners INT1102-1143 available to suit 1/2 hour and 1 hour fire doors see P319.
For 1 hour requirement please use 2 packs.

ENDUROMAX® HINGES



H2N1502/13/R

GRADE 13 LIFT OFF THRUST BEARING HINGE Radius

Dimensions (mm):

Length:	110
Width:	98
Depth:	3.5
Maximum Loading:	120kg

Variations:

- H2N1502/13/R/LEF** Left Hand
- H2N1502/13/R/RIG** Right Hand



H2N11015/13

GRADE 13 THRUST BEARING HINGE Non Removable Pin

Dimensions (mm):

Length:	100
Width:	100
Depth:	3
Maximum Loading:	120kg

Variations:

- H2N11015/13/R** Radius



ENDUROMAX® HINGES



H2N1102/13

**GRADE 13
THRUST BEARING HINGE**
Non Removable Pin

Dimensions (mm):

Length:	100
Width:	89
Depth:	3
Maximum Loading:	120kg

Variations:

H2N1102/13/R	Radius
---------------------	--------



H2N1103/13

**GRADE 13
THRUST BEARING HINGE**
Non Removable Pin

Dimensions (mm):

Length:	100
Width:	76
Depth:	3
Maximum Loading:	120kg

Variations:

H2N1103/13/R	Radius
---------------------	--------



Intumescent hinge liners INT1102-1143 available to suit 1/2 hour and 1 hour fire doors see P319.
For 1 hour requirement please use 2 packs.

ENDUROMAX® HINGES



H2N1424

**GRADE 13
PARLIAMENT HINGE**

Dimensions (mm):

Length:	102
Width:	102
Depth:	3
Projection:	50

Variations:

H2N1435	102x127x3.5x75
H2N1446	102x152x3.5x100



H2N1121/14

**GRADE 14
THRUST BEARING HINGE**
Non Removable Pin

Dimensions (mm):

Length:	125
Width:	102
Depth:	3.5
Maximum Loading:	160kg

Variations:

H2N1121/14/R	Radius
---------------------	--------



ENDUROMAX® HINGES



H3N1101/11/R



**GRADE 11 LIFT OFF
FULL LEAF HINGE** Radius

Dimensions (mm):

Length:	100
Width:	88
Depth:	3
Maximum Loading:	80kg

Variations:

- H3N1101/11/R/LEF** Left Hand
- H3N1101/11/R/RIG** Right Hand

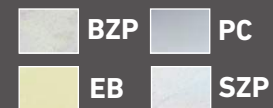

H3N1105/11/R



**GRADE 11 LIFT OFF JOURNAL
SUPPORT HINGE** Radius

Dimensions (mm):

Length:	98
Width:	82
Depth:	3
Maximum Loading:	80kg

Variations:

- H3N1105/11/R/LEF** Left Hand
- H3N1105/11/R/RIG** Right Hand

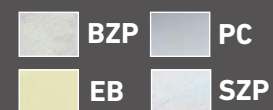

Intumescent hinge liners INT1102-1143 available to suit 1/2 hour and 1 hour fire doors see P319.
For 1 hour requirement please use 2 packs.

ENDUROMAX® HINGES



H3N1107/13/R

GRADE 13 LIFT OFF JOURNAL SUPPORT HINGE Radius

Dimensions (mm):
 Length: 110
 Width: 98
 Depth: 3.5
 Maximum Loading: 120kg

Variations:
H3N1107/13/R/LEF Left Hand
H3N1107/13/R/RIG Right Hand

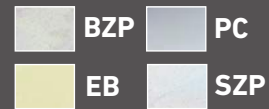

H3N1102/13

GRADE 13 TRIPLE KNUCKLE HINGE

Dimensions (mm):
 Length: 100
 Width: 88
 Depth: 3
 Maximum Loading: 120kg

Variations:
H3N1102/13/R Radius

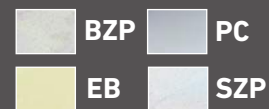

ENDUROMAX® HINGES



H3N1102A/13



GRADE 13 TRIPLE KNUCKLE PROJECTION HINGE

Dimensions (mm):

Length:	100
Width:	106
Depth:	3
Maximum Loading:	120kg

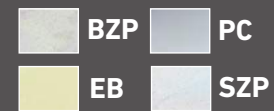

INT1433

INTUMESCENT HINGE LINER

Dimensions (mm):

Length:	100
Width:	30

Variations:

INT1102	Width 36
INT1443	Width 40



ENDUROMAX® HINGES



H2N1900

**STANDARD THRUST BEARING
PIVOT SET**

Dimensions (mm):
 Length: 130
 Width: 25
 Maximum Loading: 80kg

Variations:
 H2N1900/R Radius



H2N1950

**EMERGENCY RELEASE
DOOR STOP**

Dimensions (mm):
 Length: 80
 Width: 40
 Depth: 30



CEAM® HINGES

CI001129

CONCEALED HINGE
Dimensions (mm):

Length:	100
Width:	22
Depth:	18
Maximum Loading:	40kg

BRO00

OTT00

NIK00

VCH00

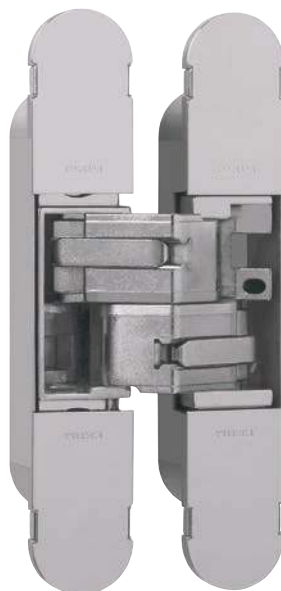
F030
CI001130

CONCEALED HINGE
Dimensions (mm):

Length:	134
Width:	24
Depth:	21
Maximum Loading:	60kg

BRO00

OTT00

NIK00

VCH00

CI001129 and CI001130 Correct fitting instructions must be adhered to for these products.
Please contact our sales office on 01228 511030 for details.

CEAM® HINGES



CI001131



CONCEALED HINGE

Dimensions (mm):

Length:	160
Width:	32
Depth:	29
Maximum Loading:	120kg

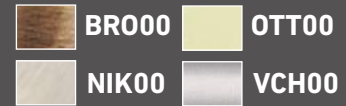



Door Controls



ENDURO® DOOR CONTROLS



AA45

CONCEALED CHAIN SPRING DOOR CLOSER

Dimensions (mm):
 Plate: 50x25
 Depth: 145

Variations:
 AA45R Radius

CP
 PB
 SC





CDC85/R



ADJUSTABLE JAMB MOUNTED DOOR CLOSER

Dimensions (mm):
 Plate: 123x26
 Depth: 170
 Maximum Door Width: 940
 Maximum Weight: 80kg
 Angle of Opening: 110°

SC





CDG003

CONTRACT OVERHEAD DOOR CLOSER FIXED POWER SIZE 3

Dimensions (mm):
 Overall: 950
 Maximum Door Width: 950
 Maximum Weight: 60kg
 Angle of Opening: 180°

SV

ENDURO® DOOR CONTROLS



DCF2003

OVERHEAD DOOR CLOSER FIXED POWER SIZE 3

Dimensions (mm):

Overall:	178x64
Maximum Door Width:	950
Maximum Weight:	60kg
Angle of Opening:	180°

Cover Packs:

DCF2003BSS/FCP	BSS
DCF2003EBP/FCP	EBP
DCF2003PNP/FCP	PNP
DCF2003PVD/FCP	PVD
DCF2003SNP/FCP	SNP
DCF2003SSS/FCP	SSS
DCF2003SV/FCP	SV



DCF2003 for matching full set cover packs see P330.

ENDURO® DOOR CONTROLS



DCT2024

**OVERHEAD DOOR CLOSER
VARIABLE POWER SIZE 2-4**

Dimensions (mm):
 Overall: 207x55
 Maximum Door Width: 1100
 Maximum Weight: 80kg
 Angle of Opening: 180°

Cover Packs:
 DCT2024/BSS/FCP BSS
 DCT2024/EBP/FCP EBP
 DCT2024/PNP/FCP PNP
 DCT2024/PVD/FCP PVD
 DCT2024/SNP/FCP SNP
 DCT2024/SSS/FCP SSS
 DCT2024/SV/FCP SV

Variations:
 DCT2024BC Backcheck

Cover Packs:
 DCT2024BC/BSS/FCP BSS
 DCT2024BC/EBP/FCP EBP
 DCT2024BC/PNP/FCP PNP
 DCT2024BC/PVD/FCP PVD
 DCT2024BC/SNP/FCP SNP
 DCT2024BC/SSS/FCP SSS
 DCT2024BC/SV/FCP SV



ENDURO® DOOR CONTROLS



DCS2024BC

**DDA COMPLIANT
OVERHEAD DOOR CLOSER
VARIABLE POWER SIZE 2-4**

Dimensions (mm):

Overall:	236x60
Maximum Door Width:	1100
Maximum Weight:	80kg
Angle of Opening:	180°

Cover Packs:

DCS2024BC/BSS/FCP	BSS
DCS2024BC/EBP/FCP	EBP
DCS2024BC/PNP/FCP	PNP
DCS2024BC/PVD/FCP	PVD
DCS2024BC/SNP/FCP	SNP
DCS2024BC/SSS/FCP	SSS
DCS2024BC/SV/FCP	SV



DCS2024BC for matching full set cover packs see P330.
DCS2024BC DDA Compliant.

ENDURO® DOOR CONTROLS



DCS2025BC

**DDA COMPLIANT
OVERHEAD DOOR CLOSER
VARIABLE POWER SIZE 2-5**

Dimensions (mm):

Overall:	236x60
Maximum Door Width:	1250
Maximum Weight:	100kg
Angle of Opening:	180°

Cover Packs:

DCS2025BC/BSS/FCP	BSS
DCS2025BC/EBP/FCP	EBP
DCS2025BC/PNP/FCP	PNP
DCS2025BC/PVD/FCP	PVD
DCS2025BC/SNP/FCP	SNP
DCS2025BC/SSS/FCP	SSS
DCS2025BC/SV/FCP	SV

Variations:

DCS2025BCDA Delayed Action

Cover Packs:

DCS2025BCDA/BSS/FCP	BSS
DCS2025BCDA/EBP/FCP	EBP
DCT2024BCDA/PNP/FCP	PNP
DCT2024BCDA/PVD/FCP	PVD
DCT2024BCDA/SNP/FCP	SNP
DCT2024BCDA/SSS/FCP	SSS
DCT2024BCDA/SV/FCP	SV



ENDURO® DOOR CONTROLS



DCS2026BC

**DDA COMPLIANT
OVERHEAD DOOR CLOSER
VARIABLE POWER SIZE 2-6**

Dimensions (mm):

Overall:	275x62
Maximum Door Width:	1400
Maximum Weight:	120kg
Angle of Opening:	180°

Cover Packs:

DCS2026BC/BSS/FCP	BSS
DCS2026BC/PVD/FCP	PVD
DCS2026BC/SSS/FCP	SSS
DCS2026BC/SV/FCP	SV

Variations:

DCS2026BCDA	Delayed Action
-------------	----------------

Cover Packs:

DCS2026BCDA/BSS/FCP	BSS
DCS2026BCDA/PVD/FCP	PVD
DCS2026BCDA/SSS/FCP	SSS
DCS2026BCDA/SV/FCP	SV



DCS2026BC/DCS2026BCDA for matching full set cover packs see P330.
Delayed action not covered by CE or certifiere.
DCS2026BC/DCS2026BCDA DDA Compliant.

ENDURO® DOOR CONTROLS

FULL SET COVER PACKS

To Match DCF2003:

DCF2003BSS/FCP	BSS
DCF2003EBP/FCP	EBP
DCF2003PNP/FCP	PNP
DCF2003PVD/FCP	PVD
DCF2003SNP/FCP	SNP
DCF2003SSS/FCP	SSS
DCF2003SV/FCP	SV

To Match DCT2024:

DCT2024/BSS/FCP	BSS
DCT2024/EBP/FCP	EBP
DCT2024/PNP/FCP	PNP
DCT2024/PVD/FCP	PVD
DCT2024/SNP/FCP	SNP
DCT2024/SSS/FCP	SSS
DCT2024/SV/FCP	SV
DCT2024BC/BSS/FCP	BSS
DCT2024BC/EBP/FCP	EBP
DCT2024BC/PNP/FCP	PNP
DCT2024BC/PVD/FCP	PVD
DCT2024BC/SNP/FCP	SNP
DCT2024BC/SSS/FCP	SSS
DCT2024BC/SV/FCP	SV

To Match DCS2024BC:

DCS2024BC/BSS/FCP	BSS
DCS2024BC/EBP/FCP	EBP
DCS2024BC/PNP/FCP	PNP
DCS2024BC/PVD/FCP	PVD
DCS2024BC/SNP/FCP	SNP
DCS2024BC/SSS/FCP	SSS
DCS2024BC/SV/FCP	SV

To Match DCS2025BC:

DCS2025BC/BSS/FCP	BSS
DCS2025BC/EBP/FCP	EBP
DCS2025BC/PNP/FCP	PNP
DCS2025BC/PVD/FCP	PVD
DCS2025BC/SNP/FCP	SNP
DCS2025BC/SSS/FCP	SSS
DCS2025BC/SV/FCP	SV
DCS2025BCDA/BSS/FCP	BSS
DCS2025BCDA/EBP/FCP	EBP
DCT2024BCDA/PNP/FCP	PNP
DCT2024BCDA/PVD/FCP	PVD
DCT2024BCDA/SNP/FCP	SNP
DCT2024BCDA/SSS/FCP	SSS
DCT2024BCDA/SV/FCP	SV

To Match DCS2026BC:

DCS2026BC/BSS/FCP	BSS
DCS2026BC/PVD/FCP	PVD
DCS2026BC/SSS/FCP	SSS
DCS2026BC/SV/FCP	SV
DCS2026BCDA/BSS/FCP	BSS
DCS2026BCDA/PVD/FCP	PVD
DCT2026BCDA/SSS/FCP	SSS
DCT2026BCDA/SV/FCP	SV



ENDURO® DOOR CONTROLS
DCX2107
HOLD OPEN ARM
To Match:
DCS2024/DCS2024BC
DCS2025BC/DCS2025BCDA
DCS2026BC/DCS2026BCDA

DCX2201/02/03
DOOR CLOSER COVER
DCX2201 To Match:
DCF2003
DCX2202 To Match:
DCS2024
DCT2024/DCT2024BC
DCS2025BC/DCS2025BCDA
DCX2203 To Match:
DCS2026BC
DCS2026BCDA

DCX2203 not available in SSS finish.

ENDUROMAX® DOOR CONTROLS



DCC2024SM

**DDA COMPLIANT
SURFACE MOUNTED SLIM
H.E DOOR CLOSER
VARIABLE POWER SIZE 2-4**

Dimensions (mm):

Overall:	215x54
Maximum Door Width:	1100
Maximum Weight:	80kg
Angle of Opening:	120°

Cover Packs:

DCP3000/BSS	BSS
DCP3000/EBP	EBP
DCP3000/PNP	PNP
DCP3000/PVD	PVD
DCP3000/SNP	SNP
DCP3000/SSS	SSS
DCP3000/SV	SV



ENDUROMAX® DOOR CONTROLS



DCC2003SM

**DDA COMPLIANT
SURFACE MOUNTED SLIM
DOOR CLOSER
FIXED POWER SIZE 3**

Dimensions (mm):

Overall:	236x59
Maximum Door Width:	950
Maximum Weight:	60kg
Angle of Opening:	120°

Cover Packs:

DCP3202/BSS	BSS
DCP3202/EBP	EBP
DCP3202/PNP	PNP
DCP3202/PVD	PVD
DCP3202/SNP	SNP
DCP3202/SSS	SSS
DCP3202/SV	SV



DCC2003SM for matching cover packs see P338.
DCC2003SM DDA Compliant.

ENDUROMAX® DOOR CONTROLS



DCC2024SM/36

**DDA COMPLIANT
SURFACE MOUNTED SLIM
H.E DOOR CLOSER
VARIABLE POWER SIZE 2-4**

Dimensions (mm):

Overall:	236x59
Maximum Door Width:	1100
Maximum Weight:	80kg
Angle of Opening:	120°

Cover Packs:

DCP3202/36/BSS	BSS
DCP3202/36/EBP	EBP
DCP3202/36/PNP	PNP
DCP3202/36/PVD	PVD
DCP3202/36/SNP	SNP
DCP3202/36/SSS	SSS
DCP3202/36/SV	SV



ENDUROMAX® DOOR CONTROLS



DCC2024CF

**DDA COMPLIANT
CONCEALED SLIM
DOOR CLOSER
VARIABLE POWER SIZE 2-4**

Dimensions (mm):
Overall: 285x54
Maximum Door Width: 1100
Maximum Weight: 80kg
Angle of Opening: 120°



ENDUROMAX® DOOR CONTROLS



DCC2003CF

**DDA COMPLIANT
CONCEALED SLIM
DOOR CLOSER
FIXED POWER SIZE 3**

Dimensions (mm):
 Overall: 305x63
 Maximum Door Width: 950
 Maximum Weight: 60kg
 Angle of Opening: 120°



EB
 PNP
 SNP

ENDUROMAX® DOOR CONTROLS



DCC2024CF/36

**DDA COMPLIANT
CONCEALED SLIM
H.E DOOR CLOSER
VARIABLE POWER SIZE 2-4**

Dimensions (mm):

Overall:	305x59
Maximum Door Width:	1100
Maximum Weight:	80kg
Angle of Opening:	120°



ENDUROMAX® DOOR CONTROLS



COVER PACKS

To Match DCC2024SM:

DCP3000/BSS	BSS
DCP3000/EBP	EBP
DCP3000/PNP	PNP
DCP3000/PVD	PVD
DCP3000/SNP	SNP
DCP3000/SSS	SSS
DCP3000/SV	SV

To Match DCC2003SM:

DCP3202/BSS	BSS
DCP3202/EBP	EBP
DCP3202/PNP	PNP
DCP3202/PVD	PVD
DCP3202/SNP	SNP
DCP3202/SSS	SSS
DCP3202/SV	SV

To Match DCC2024SM:

DCP3202/36/BSS	BSS
DCP3202/36/EBP	EBP
DCP3202/36/PNP	PNP
DCP3202/36/PVD	PVD
DCP3202/36/SNP	SNP
DCP3202/36/SSS	SSS
DCP3202/36/SV	SV

	BSS		EB		
	PNP		PVD		
	SNP		SSS		SV

ENDUROMAX® DOOR CONTROLS
DCX2002
PLATED ARM
To Match:
DCC2024SM/DCC2024SM/36
DCC2003SM
DCC2024CF/DCC2024/CF/36

 EB
 PNP
 SNP
DCX3202/DCX3202/36
DOOR CLOSER COVER
DCX3202 To Match:
DCC2024SM
DCX3202/36 To Match:
DCC2024SM/36
DCC2003SM/36

 EBP
 SNP
 PNP
 SV

ENDUROMAX® DOOR CONTROLS



DCX2003

CHANNEL FOREND

To Match:
DCC2024SM/DCC2024SM/36
DCC2003SM
DCC2024CF/DCC2024/CF/36

 **BSS**  **PVD**  **SSS**



DCFS150/EN3

DOUBLE ACTION FLOOR SPRING

Dimensions (mm):
 Overall: 325x130x40
 Maximum Door Width: 950
 Maximum Weight: 105kg
 Angle of Opening: 120°

 **BSS**  **PVD**  **SSS**

ENDUROMAX® DOOR CONTROLS



DCFS250/EN4



DOUBLE ACTION FLOOR SPRING

Dimensions (mm):

Overall:	325x130x40
Maximum Door Width:	1100
Maximum Weight:	150kg
Angle of Opening:	120°



DCTS100EN3/150EN4



CONCEALED NHO TRANSOM CLOSER POWER SIZE 3/4 WITH SIDE LOAD ACCESSORIES

DCTS100/EN3:

Overall:	293x91x38
Maximum Door Width:	950
Maximum Weight:	105kg
Angle of Opening:	130°

DCTS150/EN4:

Overall:	293x91x38
Maximum Door Width:	1100
Maximum Weight:	150kg
Angle of Opening:	130°



DCFS250/EN4 accessories available. Please contact our sales office on 01228 511030 for details.
DCTS100/EN3 and DCTS250/EN4 side load accessory pack DCXT100/SL available.

ENDUROMAX® DOOR CONTROLS



DCEM3024



**ELECTROMAGNETIC
HO/FS DOOR CLOSER
VARIABLE POWER SIZE 2-4**

Dimensions (mm):
 Overall: 228x51
 Maximum Door Width: 1100
 Maximum Weight: 80kg
 Angle of Opening: 120°



DCEM2003



**ELECTROMAGNETIC
HO/FS DOOR CLOSER
FIXED POWER SIZE 3**

Dimensions (mm):
 Overall: 275x47
 Maximum Door Width: 950
 Maximum Weight: 60kg
 Angle of Opening: 170°

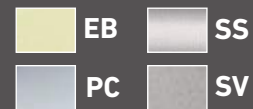

ENDUROMAX® DOOR CONTROLS



DCEM2004

**ELECTROMAGNETIC
HO/FS DOOR CLOSER
FIXED POWER SIZE 4**

Dimensions (mm):

Overall:	275x47
Maximum Door Width:	1100
Maximum Weight:	80kg
Angle of Opening:	170°

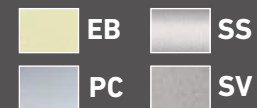

DEFB100

FLOOR MOUNTING BRACKET

Dimensions (mm):

Overall:



ENDUROMAX® DOOR CONTROLS



DEM100F

**FLUSH MOUNTED
WALL MAGNET**

Dimensions (mm):
Overall: 86x86x14



DEM100S

**SURFACE MOUNTED
WALL MAGNET**

Dimensions (mm):
Overall: 86x86x52



ENDUROMAX® DOOR CONTROLS**PSUA8/WHT****1 AMP 24v DC
POWER SUPPLY UNIT****Variations:**

PSUA8/3/WHT	3 Amp
PSUA8/5/WHT	5 Amp

 **WHT**

Panic Hardware



PANIC HARDWARE



XDB5760

PUSHBAR PANIC BOLT
c/w Vertical Rods

Dimensions (mm):
Overall Width: 760mm

Variations:

XDL5760
760mm Pushbar Panic Latch with dogging function c/w strike

XDD5760
760mm Rebated Double Pushbar Panic Bolt with dogging function c/w vertical rods

XIA5014
Metal Door Strike Pack to suit XDB5760 Panic Bolt

XIA5017
8mm Follower to Rim Tail Convertor

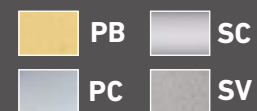

For doors greater than 900mm a longer crossbar is available.
Please contact our sales office on 01228 511030 for details.

PANIC HARDWARE



XSL5760V

NARROW STYLE PUSHBAR PANIC BOLT

c/w Pullman Latches, Rods and Covers

Dimensions (mm):

Overall Width: 760mm

Variations:

XSL5760H 760mm
Narrow Style Pushbar Panic Bolt c/w horizontal pullman latches, rods and covers

XSL5760 760mm
Narrow style pushbar panic latch c/w strike

XSD5760V 760mm
Narrow Style Rebated Double Door Pushbar Panic Bolt/Latch Set c/w vertical pullman latches, rods and covers

XSA5002 132x36mm
Narrow Style Push Pad Latch

XSA5003 150x36mm
Narrow Style (Handle) External Locking Attachment c/w cylinder

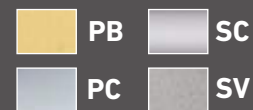

XIT5120
TOUCHBAR PANIC LATCH
 c/w Strikes

Dimensions (mm):

Overall Width: 1200mm

Variations:
XIT5760 760mm
 Touchbar Panic Latch c/w strikes

XIT5760H 760mm
 Touchbar Panic Bolt
 c/w horizontal pullman latches,
 rods and covers

XIT5760V 760mm
 Touchbar Panic Bolt
 c/w vertical pullman latches,
 rods and covers

XID5120V 1200mm
 Rebated Double Door Touchbar
 Panic Bolt/Latch Set (2xXIT5120)

XID5760V 760mm
 Rebated Double Door Touchbar
 Panic Bolt/Latch Set (2xXIT5760)

XIA5000H
 Horizontal Pullman Latches c/w
 rods and covers to suit touchbar

XIA5000V
 Vertical Pullman Latches c/w rods
 and covers to suit touchbar

XIA5012
 Dogging (Hold Back) Device
 c/w key to suit touchbar

Touchbar comes with a photoluminescent pin stripe as standard.

PANIC HARDWARE

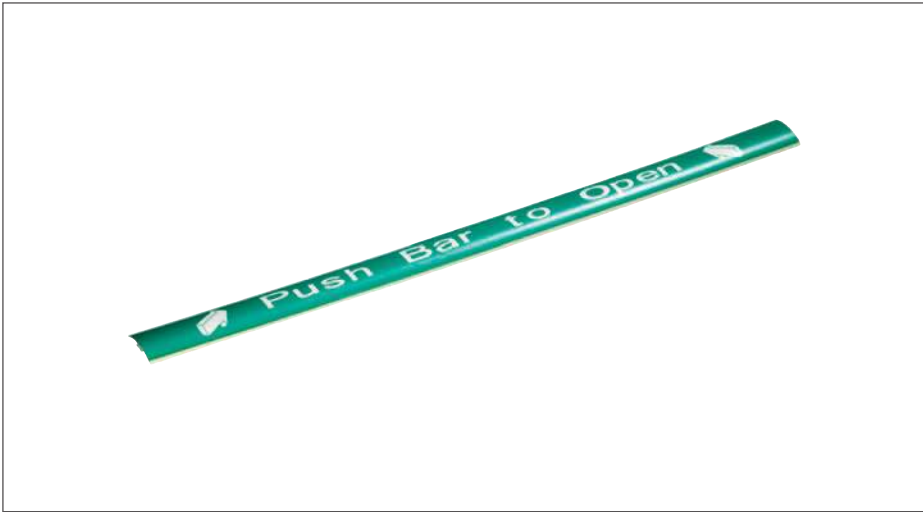

XIA5004

**PHOTO LUMINESCENT
"PUSH BAR TO OPEN" SIGN
TO SUIT TOUCHBAR**

Dimensions (mm):
Length: 603
Width: 35

- PB
- SC
- PC
- SV



XIA5002

PUSHPAD LATCH

Dimensions (mm):
Length: 125
Width: 90

- PB
- SC
- PC
- SV



XIA5003

**EXTERNAL LOCKING
ATTACHMENT**
c/w Cylinder

Dimensions (mm):
Length: 125
Width: 90





































- PB
- SC
- PC
- SV

INTUMESCENT FIRE PROTECTION AND ACOUSTIC SEALING SYSTEMS



Dimensions (mm):

CB140	25 Pack 2100x10x4 Fire Door Seal	White
CB100	25 Pack 2100x10x4 Fire Door Seal	Brown
CB145	25 Pack 2100x10x4 Fire and Smoke Door Seal	White
CB125	25 Pack 2100x10x4 Fire and Smoke Door Seal	Brown
CB120	25 Pack 2100x15x4 Fire Door Seal	White
CB110	25 Pack 2100x15x4 Fire Door Seal	Brown
CB150	25 Pack 2100x15x4 Fire Door Seal	Silver
CB115	25 Pack 2100x15x4 Fire and Smoke Door Seal	White
CB130	25 Pack 2100x15x4 Fire and Smoke Door Seal	Brown
CB155	25 Pack 2100x15x4 Fire and Smoke Door Seal	Silver
CB165	25 Pack 2100x20x4 Fire Door Seal	Brown
CB170	25 Pack 2100x20x4 Fire and Smoke Door Seal	White
CB175	25 Pack 2100x20x4 Fire and Smoke Door Seal	Brown
ES1400	2100 35 dB Acoustic Twin Blade Perimeter Seal	White
ES1401	2100 35 dB Acoustic Twin Blade Perimeter Seal	Brown
ES1403	2100 39 dB Acoustic Perimeter Corner Seal	White
ES1404	2100 39 dB Acoustic Perimeter Corner Seal	Brown
ES1405	2100 39 dB Acoustic Perimeter Corner Seal	Black
ES1238	2100 Single Action Acoustic Meeting Stile Seal	SAA
ES1240	2500 Single Action Acoustic Meeting Stile Seal	SAA
ES1239	2100 Double Action Acoustic Meeting Stile Seal	SAA
ES1241	2500 Double Action Acoustic Meeting Stile Seal	SAA

INTUMESCENT FIRE PROTECTION AND ACOUSTIC SEALING SYSTEMS

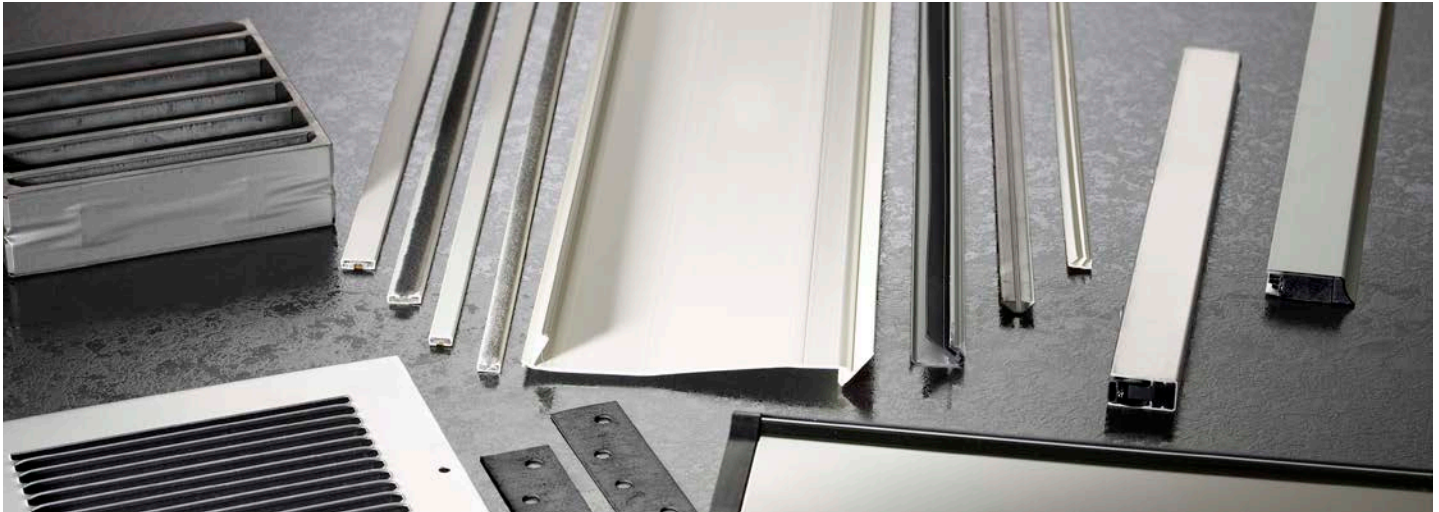

Dimensions (mm):

ES1200	330 Top 37 dB Drop Down Seal	SAA
ES1201	430 Top 37 dB Drop Down Seal	SAA
ES1202	530 Top 37 dB Drop Down Seal	SAA
ES1203	630 Top 37 dB Drop Down Seal	SAA
ES1204	730 Top 37 dB Drop Down Seal	SAA
ES1205	830 Top 37 dB Drop Down Seal	SAA
ES1206	930 Top 37 dB Drop Down Seal	SAA
ES1207	1030 Top 37 dB Drop Down Seal	SAA
ES1208	1130 Top 37 dB Drop Down Seal	SAA
ES1228	330 Surface 37 dB Drop Down Seal	SAA
ES1229	430 Surface 37 dB Drop Down Seal	SAA
ES1230	530 Surface 37 dB Drop Down Seal	SAA
ES1231	630 Surface 37 dB Drop Down Seal	SAA
ES1232	730 Surface 37 dB Drop Down Seal	SAA
ES1233	830 Surface 37 dB Drop Down Seal	SAA
ES1234	930 Surface 37 dB Drop Down Seal	SAA
ES1235	1030 Surface 37 dB Drop Down Seal	SAA
ES1236	1130 Surface 37 dB Drop Down Seal	SAA
ES1218	330 Plus 51 dB (Mortice) Drop Down Seal	SAA
ES1219	430 Plus 51 dB (Mortice) Drop Down Seal	SAA
ES1220	530 Plus 51 dB (Mortice) Drop Down Seal	SAA
ES1221	630 Plus 51 dB (Mortice) Drop Down Seal	SAA
ES1222	730 Plus 51 dB (Mortice) Drop Down Seal	SAA
ES1223	830 Plus 51 dB (Mortice) Drop Down Seal	SAA
ES1224	930 Plus 51 dB (Mortice) Drop Down Seal	SAA
ES1225	1030 Plus 51 dB (Mortice) Drop Down Seal	SAA
ES1226	1130 Plus 51 dB (Mortice) Drop Down Seal	SAA
ES1227	1230 Plus 51 dB (Mortice) Drop Down Seal	SAA



INTUMESCENT FIRE PROTECTION AND ACOUSTIC SEALING SYSTEMS



Intumescent Ancilliary Products:

INT1050	Intumescent to suit SWE1050 Sleeved Letterplate	
INT1102	Intumescent Hinge Liner 100x36mm to suit pair of hinges	4 Pack
INT1433	Intumescent Hinge Liner 100x30mm to suit pair of hinges	4 Pack
INT1443	Intumescent Hinge Liner 100x40mm to suit pair of hinges	4 Pack
ES600	Intumescent Acrylic Sealant White	310CL
ES601	Intumescent Acrylic Sealant Brown	310CL
ES804	Intumescent Lock Pack to suit Architectural Din Lock	
INT1008	Intumescent Kit to suit Lever Action Flush Bolt	
INT2024	Intumescent Kit to suit DCC2024CF Door Closer	
INT2024/36	Intumescent Kit to suit DCC2024CF/36 Door Closer	
INT2500	Intumescent Kit to suit DCFS150 Double Action Floor Spring	



INTUMESCENT FIRE PROTECTION AND ACOUSTIC SEALING SYSTEMS



ES800-803

FINGER PROTECTOR 1950mm

Finish Variations: BROWN

ES802 Opening Side 120°

ES803 Hinge Knuckle Side 105°

WHITE

ES800 Opening Side 120°

ES801 Hinge Knuckle Side 105°



ES805-808

HEAVY DUTY FINGER PROTECTOR 1950mm

Finish Variations: BROWN

ES807 Opening Side 180°

ES808 Hinge Knuckle Side 105°

WHITE

ES805 Opening Side 180°

ES806 Hinge Knuckle Side 105°



INTUMESCENT FIRE PROTECTION AND ACOUSTIC SEALING SYSTEMS

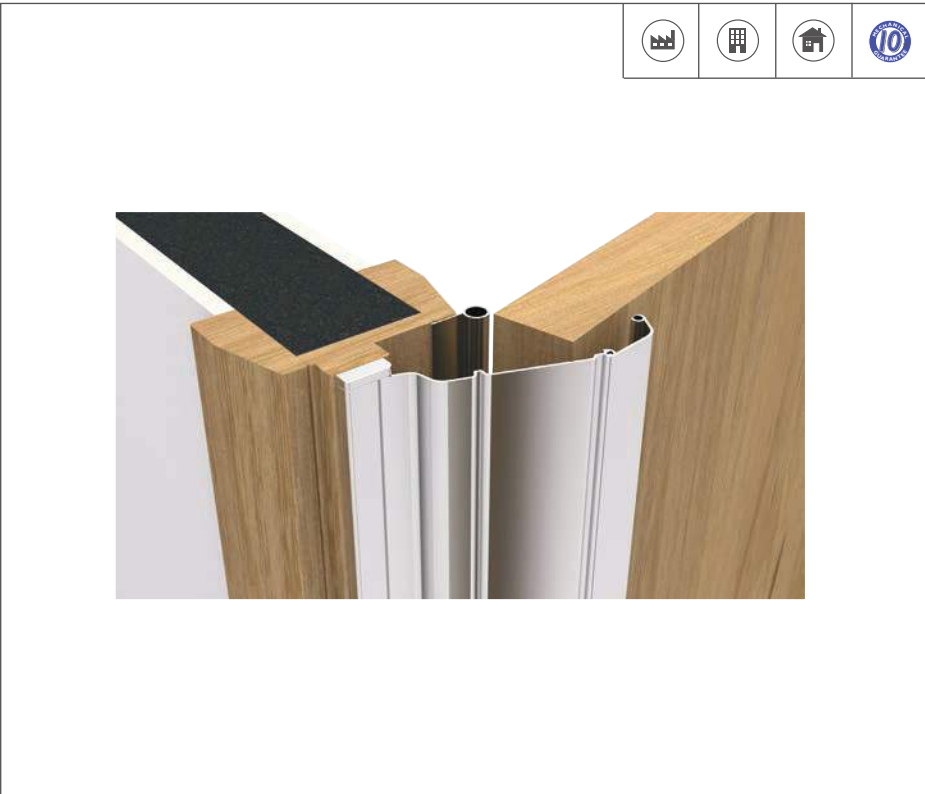

ES901-903

COMMERCIAL FINGER PROTECTOR 2000mm

Variations:

- ES901** Opening Side 120°
- ES902** Opening Side 180°
- ES903** Hinge Knuckle Side 180°

SAA



ES300-309

INTUMESCENT LETTERBOX

Finish Variations:

- CP**
- ES301** 254
- ES305** 305
- GOLD**
- ES302** 254
- ES306** 305
- PB**
- ES300** 254
- ES304** 305
- SAA**
- ES303** 254
- ES307** 305
- SSS**
- ES308** 254
- ES309** 305

CP
 PB
GOLD
 SAA
 SSS



ES400-404

AIR TRANSFER VENT

Dimensions (mm):

ES400	150x150
ES401	150x300
ES402	300x300
ES403	112x225
ES404	225x225

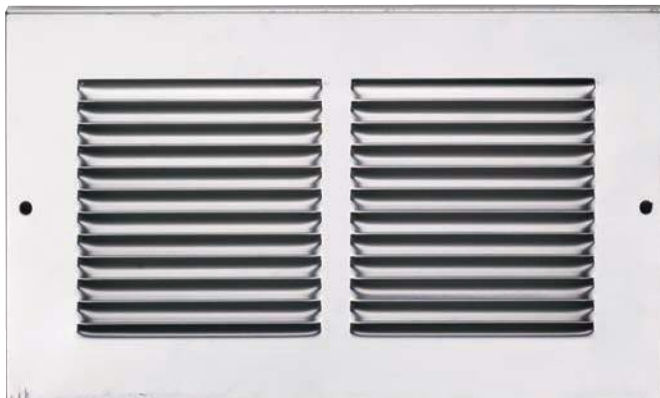

ES420-424

FACE PLATE COVER FOR AIR TRANSFER VENT

Dimensions (mm):

ES420	To match ES400 150x150
ES421	To match ES401 150x300
ES422	To match ES402 300x300
ES423	To match ES403 112x225
ES424	To match ES404 225x225





CYLINDERS MP5 STANDARD SECURITY

EURO SINGLE CYLINDER



Dimensions (mm):

CYE71140	40-30/10
CYE71145	45-35/10



EURO DOUBLE CYLINDER



Dimensions (mm):

CYE71260	60-30/30
CYE71270	70-35/35
CYE71280	80-40/40
CYE71290	90-45/45
CYE712100	100-50/50

Offset Variations:

CYE7123035	65-30/35
CYE7123040	70-30/40
CYE7123050	80-30/50
CYE7123540	75-35/40
CYE7123545	80-35/45
CYE7123550	85-35/50
CYE7124045	85-40/45
CYE7124050	90-40/50
CYE7124055	95-40/55
CYE7124060	100-40/60
CYE7124550	95-45/50
CYE7124555	100-45/55



CYLINDERS MP5 STANDARD SECURITY

EURO CYLINDER AND TURN



Dimensions (mm):

CYE71360	60-30/30
CYE71370	70-35/35
CYE71380	80-40/40
CYE71390	90-45/45

Offset Variations: 1st dimension = key side

CYE7133040	70-30/40
CYE7133540	75-35/40
CYE7133555	90-35/55
CYE7134030	70-40/30
CYE7134035	75-40/35
CYE7134050	90-40/50
CYE7134060	100-40/60
CYE7134555	100-45/55
CYE7135040	90-50/40
CYE7135535	90-55/35
CYE7135545	100-55/45
CYE7136040	100-60/40



OVAL SINGLE CYLINDER



Dimensions (mm):

CYE72140	40-30/10
CYE72145	45-35/10



CYLINDERS MP5 STANDARD SECURITY

OVAL DOUBLE CYLINDER



Dimensions (mm):

CYE72260 60-30/30
CYE72270 70-35/35



OVAL CYLINDER AND TURN



Dimensions (mm):

CYE72360 60-30/30
CYE72370 70-35/35



CYLINDERS MP5 STANDARD SECURITY

STANDARD RIM CYLINDER



Dimensions (mm):
CYE73520 32 Dia.

 NP  SB



MP5 cylinder accessories available see P382.

CYLINDERS MP5 STANDARD SECURITY

EURO SINGLE CYLINDER



Dimensions (mm):	KA	UMK
CYA71140 40-30/10	CYB74140	CYB77140
CYA71145 45-35/10	CYB74145	CYB77145
CYA71150 50-40/10	CYB74150	CYB77150



EURO DOUBLE CYLINDER



Dimensions (mm):	KA	UMK
CYA71260 60-30/30	CYB74260	CYB77260
CYA71270 70-35/35	CYB74270	CYB77270
CYA71280 80-40/40	CYB74280	CYB77280
CYA71290 90-45/45	CYB74290	CYB77290
CYA712100 100-50/50	CYB742100	CYB772100
CYA712110 110-55/55	CYB742110	CYB772110

Offset Variations:

CYA7123040 70-30/40	CYB7423040	CYB7723040
CYA7123050 80-30/50	CYB7423050	CYB7723050
CYA7123540 75-35/40	CYB7423540	CYB7723540
CYA7123545 80-35/45	CYB7423545	CYB7723545
CYA7123550 85-35/50	CYB7423550	CYB7723550
CYA7124050 90-40/50	CYB7424050	CYB7724050
CYA7124060 100-40/60	CYB7424060	CYB7724060
CYA7124550 95-45/50	CYB7424550	CYB7724550



CYLINDERS MP5 STANDARD SECURITY

RIM CYLINDER & EURO CYLINDER/TURN



Dimensions (mm):
CYA71370/73520 70-35/35



EURO CYLINDER & TURN (Pair)



Dimensions (mm):
CYA71370/2 70-35/35



MP5 cylinder accessories available see P381-382.

CYLINDERS MP5 STANDARD SECURITY

EURO CYLINDER & TURN



Dimensions (mm):	KA	UMK
CYA71360 60-30/30	CYB74360	CYB77360
CYA71370 70-35/35	CYB74370	CYB77370
CYA71380 80-40/40	CYB74380	CYB77380
CYA71390 90-45/45	CYB74390	CYB77390
CYA713100 100-50/50	CYB743100	CYB773100
Offset Variations: 1st dimension = key side		
CYA7133040 70-30/40	CYB7433040	CYB7733040
CYA7134030 70-40/30	CYB7434030	CYB7734030
CYA7133545 80-35/45	CYB7433545	CYB7733545
CYA7134535 80-45/35	CYB7434535	CYB7734535
CYA7134060 100-40/60	CYB7434060	CYB7734060
CYA7136040 100-60/40	CYB7436040	CYB7736040

 PB  PC  SC

OVAL SINGLE CYLINDER



Dimensions (mm):	KA	UMK
CYA72140 40-30/10	CYB75140	CYB78140
CYA72145 45-35/10	CYB75145	CYB78145
CYA72150 50-40/10	CYB75150	CYB78150

 PB  PC  SC

CYLINDERS MP5 STANDARD SECURITY

OVAL DOUBLE CYLINDER



Dimensions (mm):	KA	UMK
CYA72260 60-30/30	CYB75260	CYB78260
CYA72270 70-35/35	CYB75270	CYB78270
CYA72280 80-40/40	CYB75280	CYB78280



OVAL CYLINDER AND TURN



Dimensions (mm):	KA	UMK
CYA72360 60-30/30	CYB75360	CYB78360
CYA72370 70-35/35	CYB75370	CYB78370
CYA72380 80-40/40	CYB75380	CYB78380



CYLINDERS MP5 STANDARD SECURITY

STANDARD RIM CYLINDER



Dimensions (mm): **KA** **UMK**
CYA73520 32 Dia. **CYB76520** **CYB79520**

PB **PC** **SC**

THREADED RIM CYLINDER



Dimensions (mm): **KA** **UMK**
CYA73620 32 Dia. **CYB76620** **CYB79620**
CYA73620/2 32 Dia. (Pair)

PB **PC** **SC**

CYLINDERS MP5 STANDARD SECURITY

OPEN SHACKLE PADLOCK



Dimensions (mm): KA UMK
CYH7PLO47 47 CYB7PLO47KA CYB7PLO47UMK
Matching Cylinder:
CYA71130SC/O CYB74130/O CYB77130/O



CLOSED SHACKLE PADLOCK



Dimensions (mm): KA UMK
CYH7PLC55 55 CYB7PLC55KA CYB7PLC55UMK
Matching Cylinder:
CYA71130SC/C CYB74130/C CYB77130/C



CYLINDERS MP5 STANDARD SECURITY

EURO BATHROOM CYLINDER & TURN



Dimensions (mm):
CYA70470 70-35/35



EURO SINGLE THUMBTURN ONLY



Dimensions (mm):
CYA70445 45-35/10



CYLINDERS MP5 STANDARD SECURITY

LEVER INSERT FOR EURO CYLINDER LOCK



Dimensions (mm):
AEIL5000 33



AEIL5000 includes 2 mortice keys.
MP5 cylinder accessories available see P382.

CYLINDERS MPx6 HIGH SECURITY

EURO SINGLE CYLINDER



Dimensions (mm):	KA	UMK	
CYX71146	46-36/10	CYF74146	CYF77146
CYX71150	50-40/10	CYF74150	CYF77150

PB PC SC

EURO DOUBLE CYLINDER



Dimensions (mm):	KA	UMK	
CYX71270	70-35/35	CYF74270	CYF77270
CYX71280	80-40/40	CYF74280	CYF77280
CYX71290	90-45/45	CYF74290	CYF77290
CYX712100	100-50/50	CYF742100	CYF772100
CYX712110	110-55/55	CYF742110	CYF772110
Offset Variations:			
CYX7123540	75-35/40	CYF7423540	CYF7723540
CYX7123545	80-35/45	CYF7423545	CYF7723545
CYX7123550	85-35/50	CYF7423550	CYF7723550
CYX7124050	90-40/50	CYF7424050	CYF7724050
CYX7124060	100-40/60	CYF7424060	CYF7724060
CYX7124550	95-45/50	CYF7424550	CYF7724550

PB PC SC

CYLINDERS MPx6 HIGH SECURITY

EURO CYLINDER AND TURN



Dimensions (mm):	KA	UMK
CYX71370	70-35/35	CYF74370 CYF77370
CYX71380	80-40/40	CYF74380 CYF77380
CYX71390	90-45/45	CYF74390 CYF77390
CYX713100	100-50/50	CYF743100 CYF773100
Offset Variations: 1st dimension = key side		
CYX7133545	80-35/45	CYF7433545 CYF7733545
CYX7134060	100-40/60	CYF7434060 CYF7734060
CYX7134535	80-45/35	CYF7434535 CYF7734535
CYX7136040	100-60/40	CYF7436040 CYF7736040

PB PC SC

STANDARD RIM CYLINDER



Dimensions (mm):	KA	UMK
CYF73524	32 Dia.	CYF76524 CYF79524

PB PC SC

CYLINDERS MPx6 HIGH SECURITY

THREADED RIM CYLINDER



Dimensions (mm):	KA	UMK
CYF73624 32 Dia.	CYF76624	CYF79624



RESTRICTED CYLINDERS MP10 HIGH SECURITY

EURO SINGLE CYLINDER



Dimensions (mm):	KA	UMK
CYH71142 42-32/10	CYG74142	CYG77142
CYH71146 46-36/10	CYG74146	CYG77146
CYH71150 50-40/10	CYG74150	CYG77150

PB
 PC
 SC

EURO DOUBLE CYLINDER



Dimensions (mm):	KA	UMK
CYH71264 64-32/32	CYG74264	CYG77264
CYH71270 70-35/35	CYG74270	CYG77270
CYH71280 80-40/40	CYG74280	CYG77280
CYH71290 90-45/45	CYG74290	CYG77290
CYH712100 100-50/50	CYG742100	CYG772100

Offset Variations:

CYH7123240 72-32/40	CYG7423240	CYG7723240
CYH7123250 82-32/50	CYG7423250	CYG7723250
CYH7123540 75-35/40	CYG7423540	CYG7723540
CYH7123545 80-35/45	CYG7423545	CYG7723545
CYH7123550 85-35/50	CYG7423550	CYG7723550
CYH7123555 90-35/55	CYG7423555	CYG7723555
CYH7124045 85-40/45	CYG7424045	CYG7724045
CYH7124050 90-40/50	CYG7424050	CYG7724050
CYH7124055 95-40/55	CYG7424055	CYG7724055
CYH7124060 100-40/60	CYG7424060	CYG7724060
CYH7124550 95-45/50	CYG7424550	CYG7724550
CYH7124555 100-45/55	CYG7424555	CYG7724555

PB
 PC
 SC

RESTRICTED CYLINDERS MP10 HIGH SECURITY

EURO CYLINDER AND TURN



Dimensions (mm):	KA	UMK
CYH71364 64-32/32	CYG74364	CYG77364
CYH71370 70-35/35	CYG74370	CYG77370
CYH71380 80-40/40	CYG74380	CYG77380
CYH71390 90-45/45	CYG74390	CYG77390
CYH713100 100-50/50	CYG743100	CYG773100
Offset Variations: 1st dimension = key side		
CYH7133240 72-32/40	CYG7433240	CYG7733240
CYH7133545 80-35/45	CYG7433545	CYG7733545
CYH7133555 90-35/55	CYG7433555	CYG7733555
CYH7134032 72-40/32	CYG7434032	CYG7734032
CYH7134050 90-40/50	CYG7434050	CYG7734050
CYH7134060 100-40/60	CYG7434060	CYG7734060
CYH7134535 80-45/35	CYG7434535	CYG7734535
CYH7134550 95-45/50	CYG7434550	CYG7734550
CYH7135040 90-50/40	CYG7435040	CYG7735040
CYH7135045 95-50/45	CYG7435045	CYG7735045
CYH7136040 100-60/40	CYG7436040	CYG7736040

PB PC SC

CLASSROOM CYLINDERS



Dimensions (mm):	KA	UMK
CYH71370CR 70-35/35	CYG74370CR	CYG77370CR
CYH71380CR 80-40/40	CYG74380CR	CYG77380CR

PB PC SC

RESTRICTED CYLINDERS MP10 HIGH SECURITY

OVAL SINGLE CYLINDER



Dimensions (mm):	KA	UMK
CYH72142	42-32/10	CYG75142
CYH72146	46-36/10	CYG75146



OVAL DOUBLE CYLINDER



Dimensions (mm):	KA	UMK
CYH72264	64-32/32	CYG75264
CYH72270	70-35/35	CYG75270
CYH72280	80-40/40	CYG75280



RESTRICTED CYLINDERS MP10 HIGH SECURITY

OVAL DOUBLE CYLINDER AND TURN



Dimensions (mm):	KA	UMK
CYH72364	64-32/32	CYG75364 CYG78364
CYH72370	70-35/35	CYG75370 CYG78370
CYH72380	80-40/40	CYG75380 CYG78380



SCANDINAVIAN OVAL CYLINDER



Dimensions (mm):	KA	UMK
CYH72-S031	31	CYG75-S031 CYG78-S031
CYH72-SP31/31	31/31	CYG75-SP31/31 CYG78-SP31/31



RESTRICTED CYLINDERS MP10 HIGH SECURITY

OPEN SHACKLE PADLOCK



Dimensions (mm): KA UMK
CYH7PLO47 47 **CYG7PLO47KA** **CYG7PLO47UMK**
Matching Cylinder:
 CYG74130/O **CYG77130/O**



CLOSED SHACKLE PADLOCK



Dimensions (mm): KA UMK
CYH7PLC55 55 **CYG7PLC55KA** **CYG7PLC55UMK**
Matching Cylinder:
 CYG74130/C **CYG77130/C**



RESTRICTED CYLINDERS MP10 HIGH SECURITY

UNIVERSAL RIM CYLINDER



Dimensions (mm):	KA	UMK
CYH73525 32 Dia.	CYG76525	CYG79525

PB
 PC
 SC



PATENTED CYLINDERS MP15 MAXIMUM SECURITY

EURO SINGLE CYLINDER



Dimensions (mm):	KA	UMK
CYP71141 41-31/10	CYP74141	CYP77141
CYP71145 45-35/10	CYP74145	CYP77145



EURO DOUBLE CYLINDER



Dimensions (mm):	KA	UMK
CYP71262 62-31/31	CYP74262	CYP77262
CYP71270 70-35/35	CYP74270	CYP77270
CYP71282 82-41/41	CYP74282	CYP77282



MP15 cylinder accessories available see P382.

PATENTED CYLINDERS MP15 MAXIMUM SECURITY

EURO CYLINDER AND TURN



Dimensions (mm):	KA	UMK
CYP71362 62-31/31	CYP74362	CYP77362
CYP71370 70-35/35	CYP74370	CYP77370
CYP71382 82-41/41	CYP74382	CYP77382



STANDARD RIM CYLINDER



Dimensions (mm):	KA	UMK
CYP73526 32 Dia.	CYP76526	CYP79526



CYLINDER ACCESSORIES

ALTERNATIVE THUMBURNS



CYZ70006



CYZ70007



CYZ70008



CYZ70009



CYZ70011



CYZ70016



CYZ70012

Dimensions (mm):

CYZ70006	24x26	Standard Thumbturn
CYZ70007	28x34	Large Thumbturn
CYZ70008	38x25	Round Thumbturn
CYZ70009	24x26	Large Thumbturn with Grip
CYZ70011	28x31	Tall Semi-Circular Thumbturn
CYZ70012	24x28	Peanut Shaped Thumbturn
CYZ70016	28x66	Shaped Disabled Thumbturn

PB

PC

SC

CYLINDER ACCESSORIES

ACCESSORIES



CYZ73607/CYZ73610



CYZ70002



CYZ70003



CYZ70004NP/EB



CYZ70040



CYZ70060



CYZ75060



CYZ70050

- CYZ73607** Cylinder ring for threaded cylinder 7mm
CYZ73610 Cylinder ring for threaded cylinder 10mm
CYZ70002 19mm key ring
CYZ70003 Key tag
CYZ70004NP M5x65mm fixing screw (Nickel Plate)
CYZ70004EB M5x65mm fixing screw (Electro Brass)
CYZ70040 Fixing screw for rim cylinder
CYZ70060 Tail for 5/6 Pin rim cylinder
CYZ75060 Tail for 10 Pin rim cylinder
CYZ70050 Steel backplate for standard rim cylinder

KEYS



5 PIN



6 PIN



10 PIN



15 PIN

5 Pin Keys and Key Blanks:

- CYZ70000** Stocksuite master key
CYZ70001 5 Pin key blank
CYZ7000D Additional cut key/differ key
CYZ7000M Master/sub master key

6 Pin Keys and Key Blanks:

- CYZ78001NS** 6 Pin key blank
CYZ7800DNS Additional differ key
CYZ7800MNS Master/sub master key

10 Pin Keys and Key Blanks:

- CYZ75000NS** Stocksuite master key
CYZ7500CNS Construction key
CYZ7500DNS Differ key
CYZ500MNS Workshop cut master/sub master key

15 Pin Keys and Key Blanks (Colour Coded):

- CYZ72001B** Master/sub master key - blue
CYZ72001BK Differ key - black
CYZ72001R Construction key - red
CYZ72001G Grand master key - green

easi-T



E★S



PAT. GB.
01-05521-9

EUROSPEC

EASI-T CONTRACT LOCKS

	<p>ESE5025</p>
	<p>CONTRACT EURO PROFILE SASHLOCK</p> <p>Dimensions (mm): 64</p> <p>Variations: ESE5030 76</p> <p><input type="checkbox"/> EB <input type="checkbox"/> NP</p>

	<p>EDE5025</p>
	<p>CONTRACT EURO PROFILE DEADLOCK</p> <p>Dimensions (mm): 64</p> <p>Variations: EDE5030 76</p> <p><input type="checkbox"/> EB <input type="checkbox"/> NP</p>

	<p>OSE5025</p>
	<p>CONTRACT OVAL PROFILE SASHLOCK</p> <p>Dimensions (mm): 64</p> <p>Variations: OSE5030 76</p> <p><input type="checkbox"/> EB <input type="checkbox"/> NP</p>

EASI-T CONTRACT LOCKS

--	--	--	--	--	--	--



ODE5025

CONTRACT OVAL PROFILE DEADLOCK

Dimensions (mm): 64

Variations:
ODE5030 76

EB NP

--	--	--	--	--	--	--	--



BAE5025

CONTRACT BATHROOM LOCK

Dimensions (mm): 64

Variations:
BAE5025/R Radius 64
BAE5030 76
BAE5030/R Radius 76

BLACK EB NP

--	--	--	--	--	--	--	--

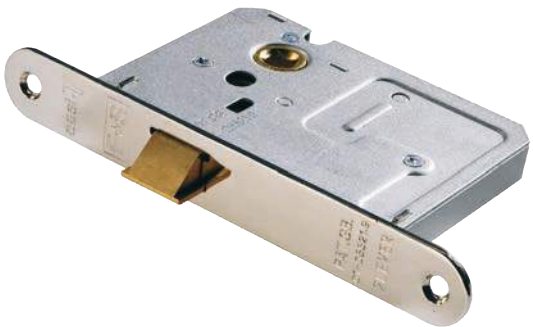

ULE5025

CONTRACT UPRIGHT LATCH

Dimensions (mm): 64

Variations:
ULE5025/R Radius 64
ULE5030 76
ULE5030/R Radius 76

EB NP

BAE5025-30 and ULE5025-30 13mm rebate kit ARE5005 available in EB and NP finish.

EASI-T CONTRACT LOCKS

--	--	--	--	--	--	--



LDE5325

CONTRACT 3 LEVER DEADLOCK

Dimensions (mm): 64

Variations:
LDE5330 76

EB NP

--	--	--	--	--	--	--



LSE5225-5330

CONTRACT SASHLOCK

Variations:

- LSE5225 2 Lever 64
- LSE5225/R 2 Lever Radius 64
- LSE5230 2 Lever 76
- LSE5230/R 2 Lever Radius 76
- LSE5325 3 Lever 64
- LSE5325/R 3 Lever Radius 64
- LSE5330 3 Lever 76
- LSE5330/R 3 Lever Radius 76

BLACK EB NP

--	--	--	--	--	--	--



LSE5225/REB

CONTRACT 2 LEVER SASHLOCK REBATED

Dimensions (mm): 64

BLACK FB
 EB NP

CONTRACT LOCKS



RDE8043

CONTRACT RIM DEADLOCK

Dimensions (mm): 102x76

Variations:

- RLE8043** Rim Latch
- RSE8053** 140x76 Rim Lock
- RSE8064** 152x102 Rim Lock

- JAP
- PC
- PB
- SC

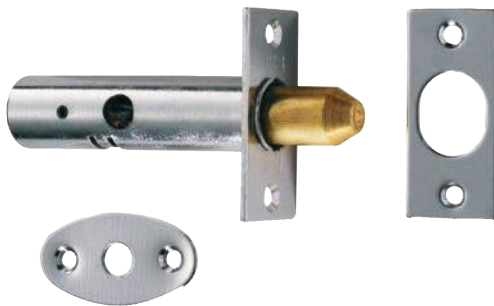

DSB8225

CONTRACT DOOR SECURITY BOLT

Dimensions (mm): 60

Variations:

- WSB8125** Radius 64

- BLACK
- PC
- WHT
- EB
- SC



DSK8000B

DOOR SECURITY BOLT KEY

Dimensions (mm):
Length: 35

Variations:

- DSK8000L** 65

RLE8043, RSE8053 and RSE8064 are not fire tested.

CONTRACT LOCKS

BL1-4

BATHROOM LOCK

Finish Variations:		EB/FB
BL1	64	
BL3	76	
		NP
BL2	64	
BL4	76	

EB

FB

NP

TL1-4

TUBULAR LATCH

Finish Variations:EB/FB/PCB	
TL1	64
TL3	76
NP	
TL2	64
TL4	76

EB

NP

FB

PCB

CONTRACT LOCKS



BTL1-4





**BOLT THROUGH
TUBULAR LATCH**





Finish Variations:	EB
BTL1	64
BTL3	76
	NP
BTL2	64
BTL4	76







BTL1-4 13mm TL9A rebate kit available in EB and NP finish.
BTL1-4 supplied with radius and square face plates.



CONTRACT LOCKS



	   	RCB8260
	<p>CONTRACT RIM CYLINDER ROLLERBOLT</p> <p>Dimensions (mm): 60</p> <p>Variations: RCB8260L Lockcase Only</p> <p> EB PC SC </p>	



	   	RCN8240
	<p>CONTRACT RIM CYLINDER NIGHTLATCH</p> <p>Dimensions (mm): 40</p> <p>Variations: RCN8240L Lockcase Only</p> <p> EB PC SC </p>	

	   	RCN8260
	<p>CONTRACT RIM CYLINDER NIGHTLATCH</p> <p>Dimensions (mm): 60</p> <p>Variations: RCN8260L Lockcase Only</p> <p> EB PC SC </p>	

CONTRACT LOCKS

	<p>RCN8160</p>
	<p>TRADITIONAL RIM CYLINDER NIGHTLATCH</p> <p>Dimensions (mm): 60</p> <p>EB GN</p>

	<p>RCN8340</p>
	<p>DEADLOCKING RIM CYLINDER NIGHTLATCH</p> <p>Dimensions (mm): 40</p> <p>Variations: RCN8340L Lockcase Only</p> <p>EB PC SC</p>

	<p>RCN8360</p>
	<p>DEADLOCKING RIM CYLINDER NIGHTLATCH</p> <p>Dimensions (mm): 60</p> <p>Variations: RCN8360L Lockcase Only</p> <p>EB PC SC</p>

RCN8160 supplied with PB finish rim cylinder.
RCN8340 and RCN8360 supplied with matching finish cylinder and 3 keys.

EASI-T CONTRACT DIN LOCKS

--	--	--	--	--	--	--	--

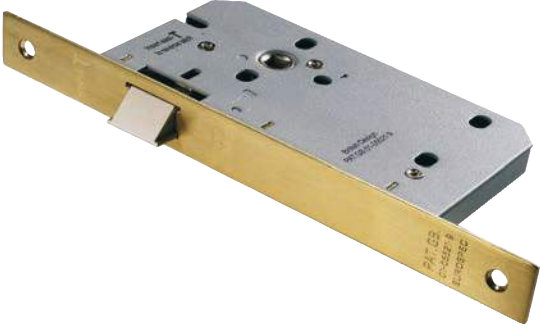

DLE0055L

CONTRACT DIN LATCH

Dimensions (mm): 55

Variations:
DLE0055L/R Radius

PVD SSS

--	--	--	--	--	--	--	--



DLE0055EP

CONTRACT DIN EURO PROFILE DEADLOCK

Dimensions (mm): 55

Variations:
DLE0055EP/R Radius

PVD SSS

--	--	--	--	--	--	--	--



DLE7255EP

CONTRACT DIN EURO PROFILE SASHLOCK

Dimensions (mm): 55
Centres: 72

Variations:
DLE7255EP/R Radius

PVD SSS

EASI-T CONTRACT DIN LOCKS



DLE7255NL

CONTRACT DIN EURO PROFILE NIGHTLATCH

Dimensions (mm): 55
Centres: 72

Variations:
DLE7255NL/R Radius

PVD SSS



DLE7855WC

CONTRACT DIN BATHROOM LOCK

Dimensions (mm): 78
Centres: 78
Follower 5 - 55

Variations:
DLE7855WC/R Radius
DLE7855WC/8 Follower 8

PVD SSS

13mm rebate kit ARDE5005 available in SSS finish.

EASI-T ARCHITECTURAL LOCKS



LDS5325-5530

DEADLOCK

Variations:

LDS5325	3 Lever 64
LDS5330	3 Lever 76
LDS5525	5 Lever 64
LDS5530	5 Lever 76



LSS5325-5530

SASHLOCK

Variations:

LSS5325	3 Lever 64
LSS5330	3 Lever 76
LSS5525	5 Lever 64
LSS5530	5 Lever 76



RSL5030

ROLLER BOLT EURO PROFILE DEADLOCK

Dimensions (mm): 76



EASI-T ARCHITECTURAL LOCKS

--	--	--	--	--	--	--



EDS5025

EURO PROFILE DEADLOCK

Dimensions (mm): 64

Variations:
EDS5030 76

PVD SSS

--	--	--	--	--	--	--



ESS5025

EURO PROFILE SASHLOCK

Dimensions (mm): 64

Variations:
ESS5030 76

PVD SSS

--	--	--	--	--	--	--



ODS5025

OVAL PROFILE CYLINDER DEADLOCK

Dimensions (mm): 64

Variations:
ODS5030 76

PVD SSS

EDS5025-30 13mm ARD5205 and 25mm ARD5210 rebate kits available in PVD and SSS finish.
 ESS5025-30 13mm ARS5105 and 25mm ARS5110 rebate kits available in PVD and SSS finish.
 ODS5025-30 13mm ARD5205 and 25mm ARD5210 rebate kits available in PVD and SSS finish.
 Radius forend and strike pack available. Contact our sales office on 01228 511030 for details.



EASI-T ARCHITECTURAL LOCKS

--	--	--	--	--	--	--	--



OSS5025

OVAL PROFILE CYLINDER SASHLOCK

Dimensions (mm): 64

Variations: OSS5030 76

PVD SSS

--	--	--	--	--	--	--	--



BAS5025

BATHROOM LOCK

Dimensions (mm):
Follower 5 - 64

Variations: BAS5030 Follower 5 - 76

PVD SSS

--	--	--	--	--



MCN5025

EURO PROFILE CYLINDER NIGHTLATCH - CASE ONLY

Dimensions (mm): 64

Variations: MCN5030 76

SSS

EUROSPEC

OSS5025-30 13mm ARS5105 and 25mm ARS5110 rebate kits available in PVD and SSS finish.
 BAS5025 13mm ARS5105 and 25mm ARS5110 rebate kits available in PVD and SSS finish.
 MCN5025-30 13mm ARM5005 rebate kit available in SSS finish.
 Radius forend and strike pack available. Contact our sales office on 01228 511030 for details.

EASI-T ARCHITECTURAL LOCKS

--	--	--	--	--	--	--



FLD8025

FLAT DEADLOCK

Dimensions (mm): 64

Variations:

FLD8030	76
FLD8040	102

EB
 SCP

--	--	--	--	--	--	--



FLL8025

FLAT LATCH

Dimensions (mm): 64

Variations:

FLL8030	76
FLL8040	102

EB
 SCP

--	--	--	--	--	--	--



FLL5025

FLAT LATCH

Dimensions (mm): 64





Variations:







FLL5030	76
FLL5040	102

EB
 SSS

FLL8025-40 13mm ARF8105 rebate kit available in EB and SCP finish.
 FLL5025-40 13mm ARF5005 rebate kit available in EB and SCP finish.
 Radius forend and strike pack available. Contact our sales office on 01228 511030 for details.
 FLL5040 not available in EB finish. FLD8025-40 and FLL8025-40 do not have Easi-T facility.

EASI-T ARCHITECTURAL LOCKS

	    	LCP1000
	<p>EURO SECURITY CYLINDER PULL WITH MINI LEVER</p> <p>Dimensions (mm): 94x52</p> <p> PC SAA PVD SC </p>	

	    	FLE8030
	<p>MORTICE BOX LATCH</p> <p>Dimensions (mm): 76 Backset: 63</p> <p> NP </p>	

	       	ULS5025
	<p>UPRIGHT LATCH</p> <p>Dimensions (mm): 64</p> <p>Variations: ULS5030 76</p> <p> PVD SSS </p>	

EASI-T ARCHITECTURAL LOCKS

DLD5030-50

TUBULAR DEAD BOLT

Variations:

DLD5030	Follower 8 - 76
DLD5040	Follower 8 - 102
DLD5050	Follower 8 - 127

FB

PB

SS

TLD5030-5850

TUBULAR DEAD BOLT

Variations:

TLD5030	Follower 5 - 76
TLD5040	Follower 5 - 102
TLD5050	Follower 5 - 127
TLD5830	Follower 8 - 76
TLD5840	Follower 8 - 102
TLD5850	Follower 8 - 127

EB

SSS

DL5025-50

HEAVY SPRUNG TUBULAR LATCH

Variations:

DL5025	Follower 8 - 64
DL5030	Follower 8 - 76
DL5040	Follower 8 - 102
DL5050	Follower 8 - 127









FB







PB







SS

TLD5030-5850 and DL5025-50 13mm ART5005 rebate kit available.
 TLD5030-5850 conversion kit available. Contact our sales office on 01228 511030 for details.
 DL5025-50 does not have Easi-T facility.

EASI-T ARCHITECTURAL LOCKS

			 <small>APPROVED PRODUCT CF611</small>		 <small>BS EN 12209</small>		 <small>FD30/60</small>	<h2 style="margin: 0;">TLS8030</h2>
								<p>HEAVY SPRUNG TUBULAR LATCH</p> <p>Dimensions (mm): Follower 8 - 76</p> <div style="display: flex; justify-content: space-around; margin-top: 10px;"> <div style="display: flex; align-items: center;"> EB</div> <div style="display: flex; align-items: center;"> NP</div> <div style="display: flex; align-items: center;"> SC</div> </div>

			 <small>BS EN 12209</small>		<h2 style="margin: 0;">TLM503045/57</h2>				
					<p>MAGNETIC TUBULAR LATCH</p> <p>Variations:</p> <table style="width: 100%; border: none;"> <tr> <td style="width: 60%;">TLM5030/45</td> <td>Backset 45</td> </tr> <tr> <td>TLM5030/57</td> <td>Backset 57</td> </tr> </table> <div style="display: flex; justify-content: space-around; margin-top: 10px;"> <div style="display: flex; align-items: center;"> BSS</div> <div style="display: flex; align-items: center;"> PVD</div> <div style="display: flex; align-items: center;"> FB</div> <div style="display: flex; align-items: center;"> SSS</div> </div>	TLM5030/45	Backset 45	TLM5030/57	Backset 57
TLM5030/45	Backset 45								
TLM5030/57	Backset 57								

			 <small>APPROVED PRODUCT CF611</small>		 <small>BS EN 12209</small>		 <small>FD30/60</small>	<h2 style="margin: 0;">URLS5325-5530</h2>								
								<p>UNIVERSAL REPLACEMENT SASHLOCK</p> <p>Variations:</p> <table style="width: 100%; border: none;"> <tr> <td style="width: 60%;">URLS5325</td> <td>3 Lever 64</td> </tr> <tr> <td>URLS5330</td> <td>3 Lever 76</td> </tr> <tr> <td>URLS5525</td> <td>5 Lever 64</td> </tr> <tr> <td>URLS5530</td> <td>5 Lever 76</td> </tr> </table> <div style="display: flex; justify-content: space-around; margin-top: 10px;"> <div style="display: flex; align-items: center;"> PVD</div> <div style="display: flex; align-items: center;"> SSS</div> </div>	URLS5325	3 Lever 64	URLS5330	3 Lever 76	URLS5525	5 Lever 64	URLS5530	5 Lever 76
URLS5325	3 Lever 64															
URLS5330	3 Lever 76															
URLS5525	5 Lever 64															
URLS5530	5 Lever 76															

EASI-T ARCHITECTURAL LOCKS



URES5025-30

UNIVERSAL REPLACEMENT EURO PROFILE SASHLOCK

Variations:

URES5025	64
URES5030	76



UROS5025-30

UNIVERSAL REPLACEMENT OVAL PROFILE SASHLOCK

Variations:

UROS5025	64
UROS5030	76



URBS5025-30

UNIVERSAL REPLACEMENT BATHROOM SASHLOCK

Variations:

URBS5025	64
URBS5030	76



Universal replacement deadlocks also available. Contact our sales office on 01228 511030 for details.

EASI-T ARCHITECTURAL DIN LOCKS

--	--	--	--	--	--	--



DLS0060EP

DIN EURO PROFILE DEADLOCK

Dimensions (mm): 60

Variations:
DLS0060EPSSS/R Radius

SSS

--	--	--	--	--	--	--



DLS0060L

DIN LATCH

Dimensions (mm): 60

Variations:
DLS0060LSSS/R Radius

SSS

--	--	--	--	--	--	--	--



DLS7260EP

DIN EURO PROFILE SASHLOCK

Dimensions (mm): 60
Centres: 72

Variations:
DLS7260EPSSS/R Radius

SSS

EUROSPEC DLS0060EP 13mm ARDS5005 rebate kit available in SSS finish. DLS0060L 13mm ARDS5005 rebate kit available in SSS finish. DLS7260EP 13mm ARDS5005 rebate kit available in SSS finish. DLS0060EP, DLS0060L and DLS7260EP also available in BSS and PVD finish using strike plate and forend kit. ASS5100 100mm split spindle with lock back feature available. ALP5038 1/2 set fixing plate also available. Contact our sales office on 01228 511030 for details.

EASI-T ARCHITECTURAL DIN LOCKS

--	--	--	--	--	--	--	--	--



DLS7260NLA

DIN EURO PROFILE NIGHTLATCH Anti-Thrust Snib

Dimensions (mm): 60
Centres: 72

Variations:
DLS7260NLASSS/R Radius

SSS

--	--	--	--	--	--	--	--



DLS7860WC

DIN BATHROOM LOCK

Dimensions (mm): 60
Centres: 78

Variations:
DLS7860WCSSS/R Radius
DLS7860WC/8/SSS Follower 8

SSS

--	--	--	--	--	--	--	--	--



DLS7260ESC

DIN EURO PROFILE ESCAPE LOCK

Dimensions (mm): 60
Centres: 72

Variations:
DLS7260ESCSSS/R Radius

SSS

DLS7260NLA 13mm ARDS5005 rebate kit available in SSS finish. DLS7860WC 13mm ARDS5005 rebate kit available in SSS finish. DLS7260ESC 13mm ARDS5005 rebate kit available in SSS finish. DLS7260NLA, DLS7860WC and DLS7260EESC also available in BSS and PVD finish using strike plate and forend kit. ASS5100 100mm split spindle with lock back feature available. ALP5038 1/2 set fixing plate also available. Contact our sales office on 01228 511030 for details.



EASI-T BRITISH STANDARD LOCKS



LDB5525

5 LEVER BS DEADLOCK

Dimensions (mm): 64

Variations:
LDB5530 76

 PVD  SSS



LSB5525

5 LEVER BS SASHLOCK

Dimensions (mm): 64

Variations:
LSB5530 76

 PVD  SSS



EDB5025

EURO PROFILE BS CYLINDER DEADLOCK - COMPLETE SET

Dimensions (mm): 64

Variations:
EDB5030 76

 PVD  SSS

EASI-T BRITISH STANDARD LOCKS

--	--	--	--	--	--	--	--	--	--



ESB5025

EURO PROFILE BS CYLINDER SASHLOCK - COMPLETE SET

Dimensions (mm): 64

Variations:
ESB5030 76

PVD SSS

--	--	--	--	--	--	--	--	--	--



EDB5025/CT

EURO PROFILE BS CYLINDER & TURN DEADLOCK - COMPLETE SET

Dimensions (mm): 64

Variations:
EDB5030/CT 76

PVD SSS

--	--	--	--	--	--	--	--	--	--



ESB5025/CT

EURO PROFILE BS CYLINDER & TURN SASHLOCK - COMPLETE SET

Dimensions (mm): 64

Variations:
ESB5030/CT 76

PVD SSS

ESB5025 13mm ARB5305 and 25mm ARB5310 rebate kits available in PVD and SSS finish.
 EDB5025-30CT 13mm ARB5405 and 25mm ARB5410 rebate kits available in PVD and SSS finish.
 ESB5025-30CT 13mm ARB5305 and 25mm ARB5310 rebate kits available in PVD and SSS finish.
 Radius forend and strike pack available. Contact our sales office on 01228 511030 for details.

LOCKS



LFB2

FIRE BRIGADE LOCK

Dimensions (mm): 51

Fire Brigade Lock Key:
AKSFB2



SSS



CL155SGVCB

**MECHANICAL DIGITAL
DOOR LOCK**

Dimensions (mm):
Latch: 60



SV

Window Fittings



WINDOW FITTINGS

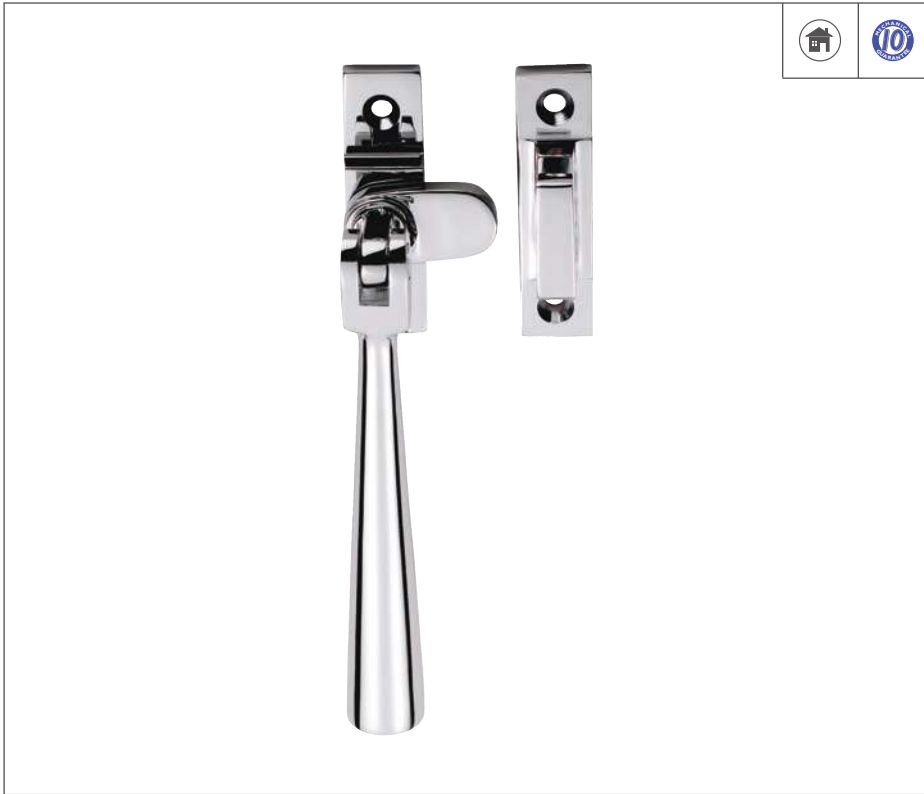

SZS73

CASEMENT FASTENER

Not Suitable for Weather Stripped Windows

Dimensions (mm):

Length: 120

- CP
- PB
- SC
- SN



SZS44S

CASEMENT FASTENER

Dimensions (mm):

Length: 254

Variations:

- SZS44C** 203
- SZS44B** 305

- CP
- SC
- SN

WINDOW FITTINGS



WF30

SQUARE CASEMENT FASTENER

Complete with Hook Plate and Flat Keep

Suitable for Weather Stripped Windows

Dimensions (mm):

Length: 125

 SS

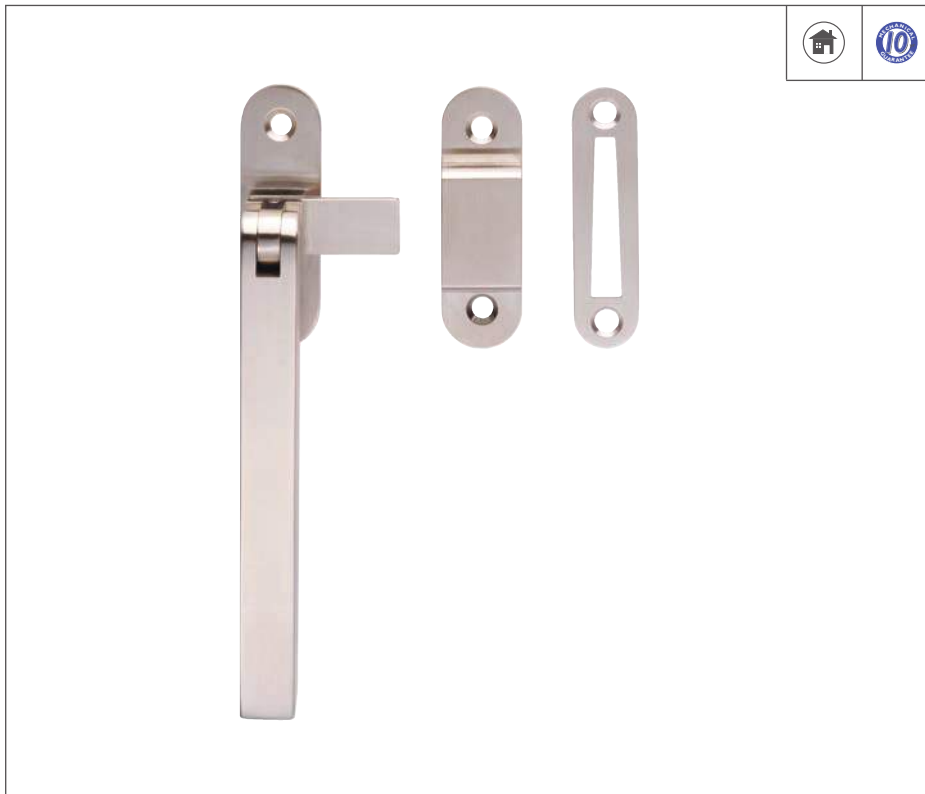

WF32

SQUARE CASEMENT STAY





Dimensions (mm):





Length: 253

 SS



WINDOW FITTINGS

	 	WF35
		SQUARE LOCKING ESPAG FASTENER Dimensions (mm): Length: 125
		 SS

	 	WF21
		ROUND CASEMENT FASTENER Complete with Hook Plate and Flat Keep Suitable for Weather Stripped Windows Dimensions (mm): Length: 125
		 SS

WINDOW FITTINGS

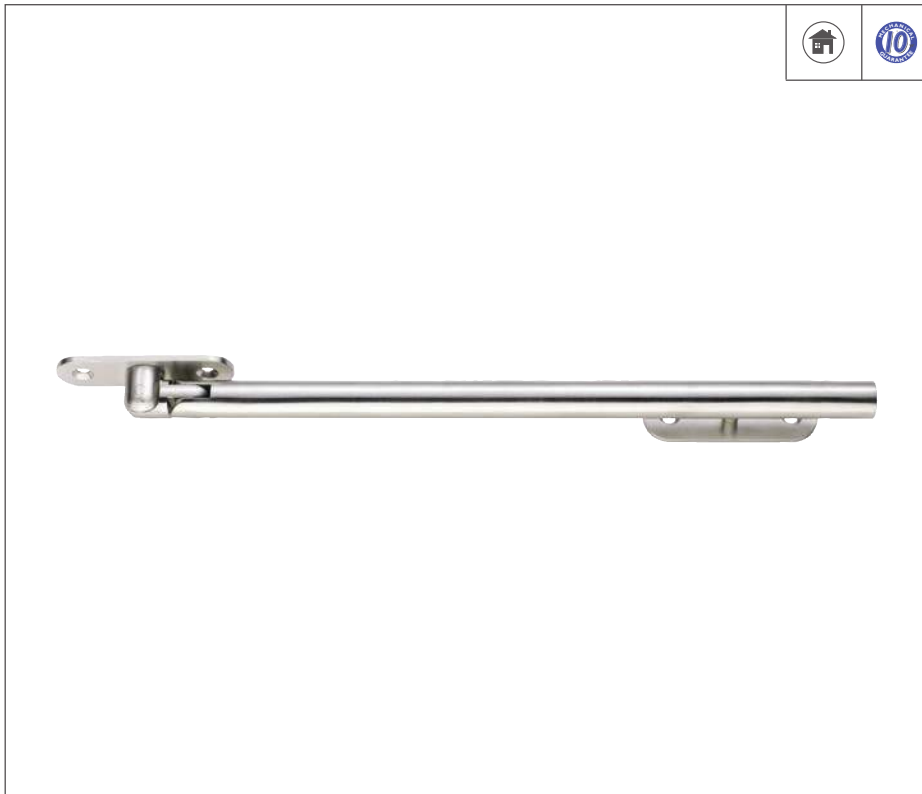

WF22S

ROUND CASEMENT STAY

Dimensions (mm):

Length: 253

Variations:

WF23 203

WF24 305

 **SS**

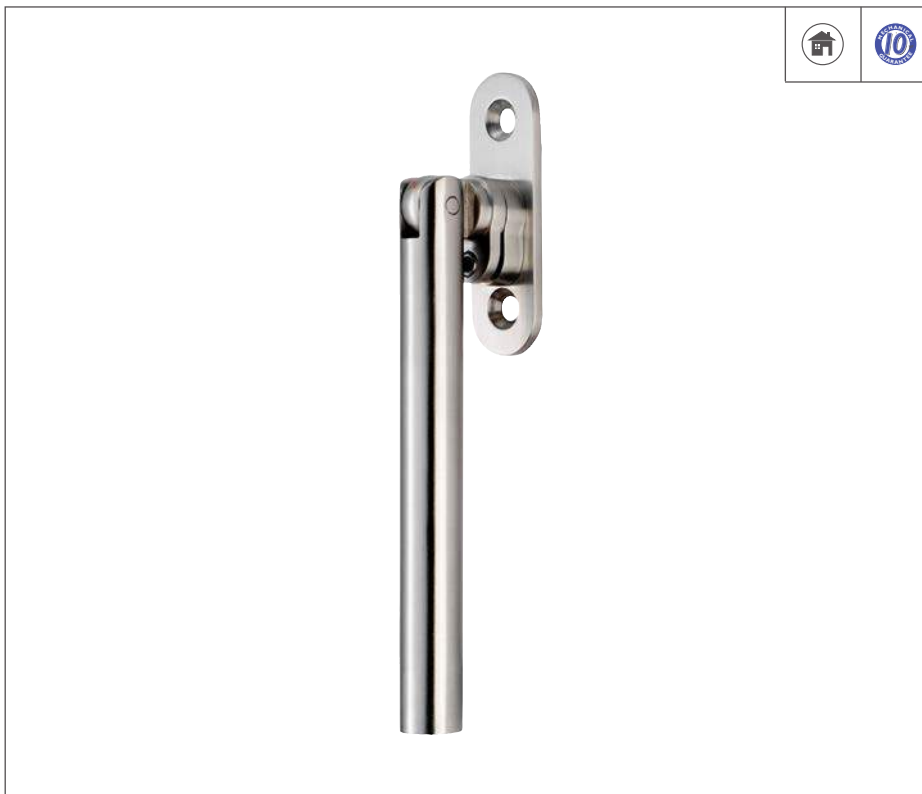

WF25

ROUND LOCKING ESPAG FASTENER



Dimensions (mm):

Length: 125

 **SS**

WINDOW FITTINGS













WF12S



BULB END CASEMENT STAY

Dimensions (mm):
Length: 254

Variations:
WF12C 202
WF12B 305

 CP	 FB	 SC
 DB	 PB	 SN











M44S



VICTORIAN CASEMENT STAY

Dimensions (mm):
Length: 254

Variations:
M44C 202
M44B 305

 CP	 PB	 SN
 DB	 SC	



AA73

SCREW DOWN PATTERN CASEMENT STAY

Dimensions (mm):
Length: 254

 PB



WF12B not available in FB and SN finish. WF12C not available in DB, FB and SN finish. M44B not available in SN finish. M44C not available in DB or SN finish. For matching casement fasteners see P416.

WINDOW FITTINGS



DK7



QUADRANT ARM STAY

Dimensions (mm):
Length: 150



DK8



ROLLER ARM STAY

Dimensions (mm):
Length: 150



AA96



SASH HANDLE



Dimensions (mm):
Length: 102

Variations:
AA97 152



WINDOW FITTINGS











WF14

PIN FOR FLUSH FITTING CASEMENT

Dimensions (mm):
Overall: 42x39

 CP
 PB
 SC











WF15

EJMA PIN
9° Bevel for EJMA Windows

Dimensions (mm):
Plate: 40x15
Height: 27°

 CP
 PB
 SC











WF17

LOCKING CASEMENT STAY PIN

Dimensions (mm):
Plate: 40x15
Height: 35

 CP
 PB
 SC

 FB
 PCB

WINDOW FITTINGS



V1006LCK

LOCKING CASEMENT FASTENER

Wedge Pattern Locking
 Suitable for Weather Stripped
 Windows

Dimensions (mm):

Overall: 13x57



V1008LH/RH

CRANKED LOCKING ESPAG HANDLE

V1008LH - Left hand
 V1008RH - Right Hand

Suitable for Weather Stripped
 Windows

Dimensions (mm):

Length: 110

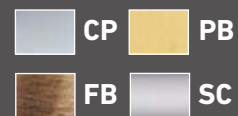

WINDOW FITTINGS

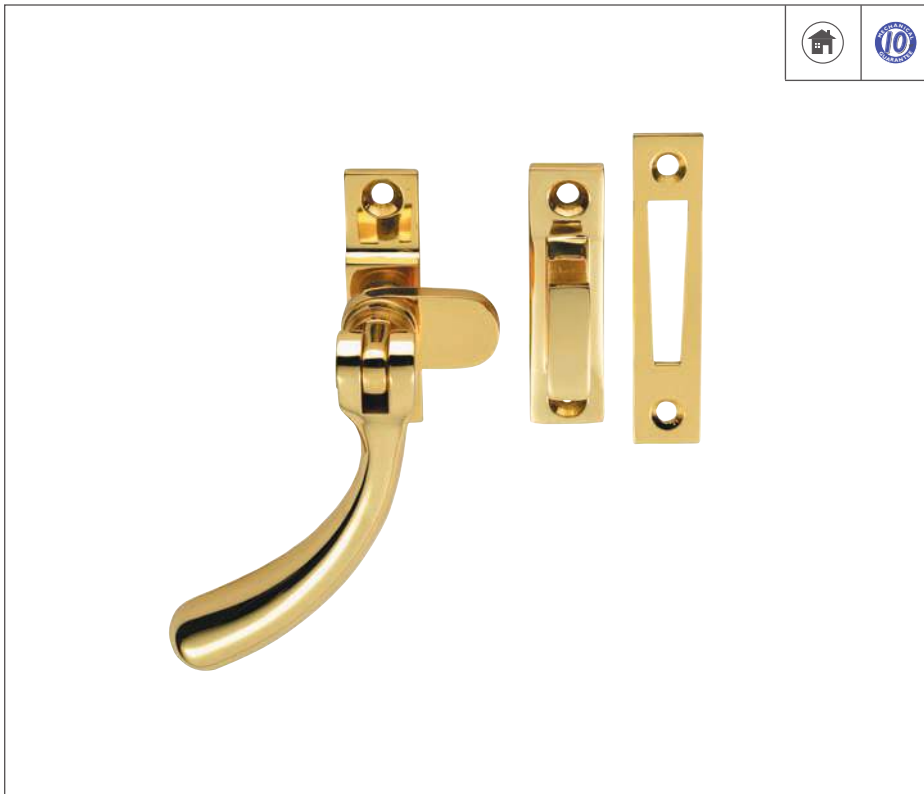

WF11

BULB END CASEMENT FASTENER

Both Hook and Mortice Plate
Suitable for Weather Stripped Windows

Dimensions (mm):

Length: 98

Variations:

WF16 Mortice Plate only

Suitable for Weather Stripped Windows

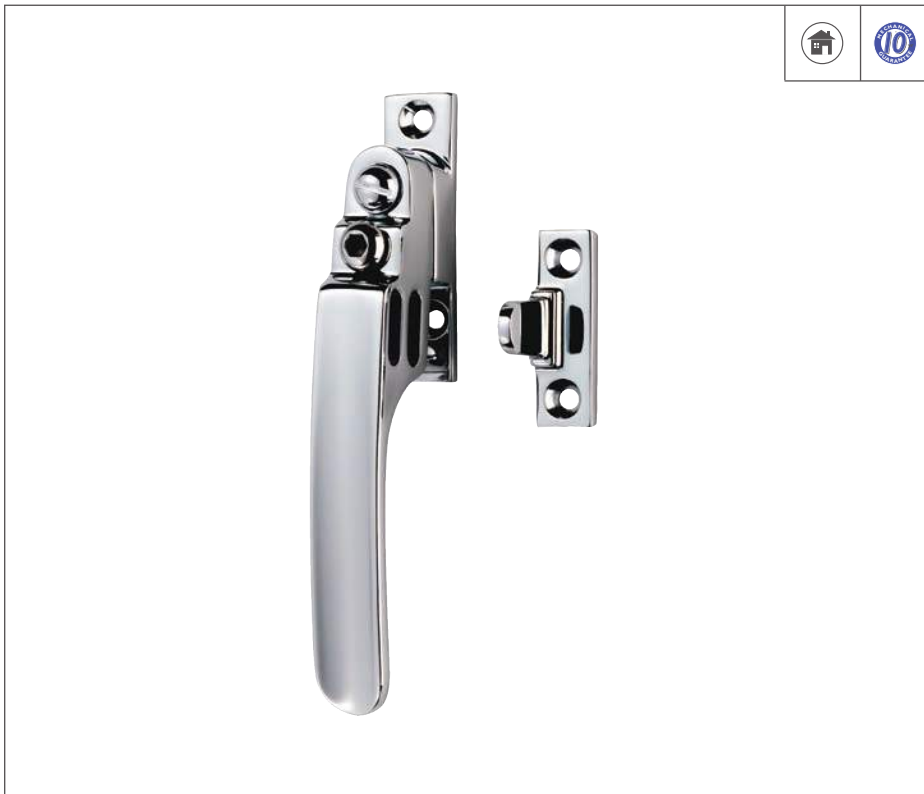
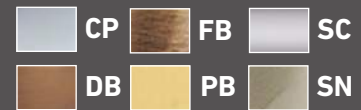

V1007LCK

VICTORIAN LOCKING CASEMENT FASTENER WITH NIGHT VENT

Suitable for Weather Stripped Windows

Dimensions (mm):

Backplate: 16x60



WINDOW FITTINGS



V1005



CASEMENT FASTENER

Wedge Pattern

Suitable for Weather Stripped Windows

Dimensions (mm):

Backplate: 57x13

Variations:

V1005LCK

Wedge Pattern

Locking Casement Fastener

Backplate: 57x13



M73



CASEMENT FASTENER

REVERSIBLE

Reversible Pattern

Both Hook and Mortice Plate

Not Suitable for Weather Stripped Windows

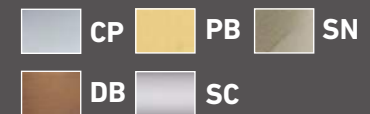

Dimensions (mm):

Backplate: 57x13



WINDOW FITTINGS



AA40

FITCH PATTERN SASH FASTENER

Dimensions (mm):
Overall: 64x25



Variations:
AA40LCK Locking Fitch Pattern Sash Fastener

CP

PB

SC



AQ39

ARCHITECTURAL QUALITY QUADRANT SASH FASTENER

Dimensions (mm):
Overall: 70x20



CP

PB

SC

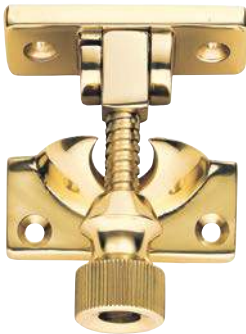
SN



AQ43

ARCHITECTURAL QUALITY BRIGHTON SASH FASTENER

Dimensions (mm):
Overall: 57x20

CP

PB

SC

SN

WINDOW FITTINGS



AA39

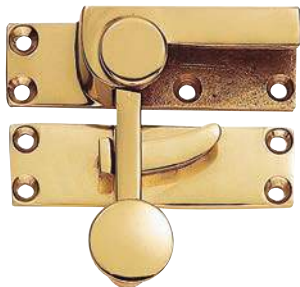

QUADRANT ARM SASH FASTENER

Dimensions (mm):

Overall: 70x20

 **PB**



AA41

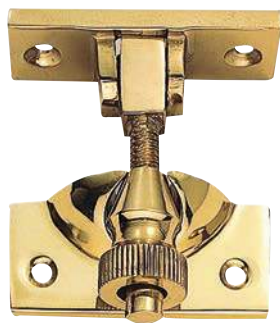

BRIGHTON PATTERN SASH FASTENER

Dimensions (mm):

Overall: 57x20

 **PB**



DK42



FAN LIGHT CATCH

Dimensions (mm):

Overall: 45x45

 **CP**  **PB**  **SC**



WINDOW FITTINGS

AQ42

GROOVED SASH LIFT

Dimensions (mm):
Overall: 52x48

CP

PB

SC

SN

AA42

SASH LIFT

Dimensions (mm):
Overall: 50x45

CP

PB

SC

AA42RI

RING SASH LIFT

Dimensions (mm):
Overall: 46x37

Variations:
AA42R
Horizontal Fix: 44x34

CP

PB

SC

WINDOW FITTINGS



AQ50



SASH WINDOW LIFT

Dimensions (mm):

Overall: 63x24

- CP
- PB
- SC
- SN



AQ91



SASH WINDOW AXLE PULLEY

Galv Forend with Nylon Wheel

Dimensions (mm):

Forend: 117x25
 Body: 76x39
 Pulley: 42 Outer Dia.
 Wheel Thickness: 10

- GALV



WINDOW FITTINGS

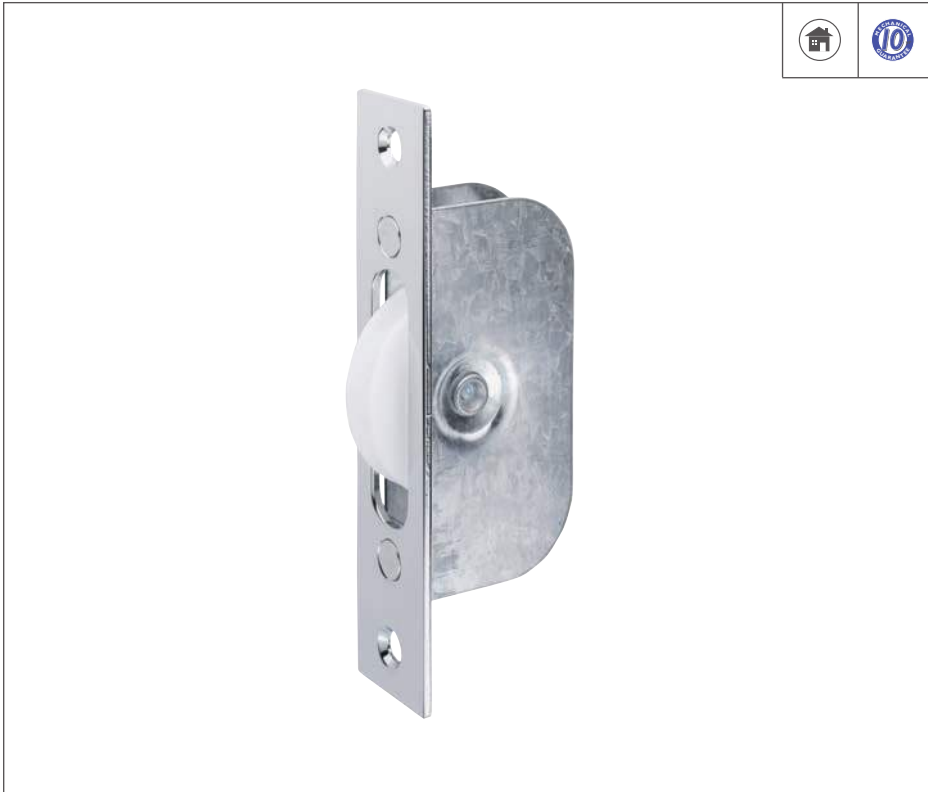

AQ92

SASH WINDOW AXLE PULLEY
Square Forend with Nylon Wheel

Dimensions (mm):
Forend: 117x25
Body: 76x39
Pulley: 42 Outer Dia.
Wheel Thickness: 10

Variations:

AQ96
Heavy Duty Radius Forend with Brass Wheel

Dimensions (mm):
Forend: 127x28
Body: 83x52
Pulley: 50 Outer Dia.
Wheel Thickness: 13

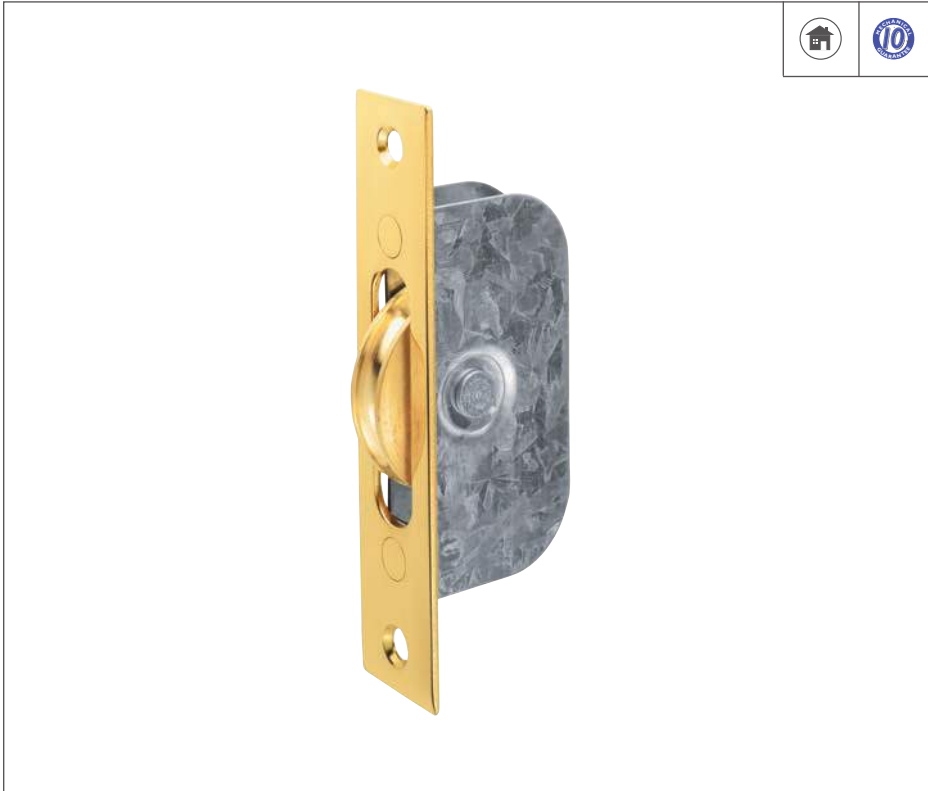

AQ93

SASH WINDOW AXLE PULLEY
Square Forend with Brass Wheel



Dimensions (mm):
Forend: 117x25
Body: 76x39
Pulley: 42 Outer Dia.
Wheel Thickness: 10





DE L'EAU 316 STAINLESS STEEL



LX21

SINGLE TOWEL RAIL

Dimensions (mm):

Width:	450
Height:	52
Projection:	85



Variations:

LX22 Width:	650
LX23 Width:	850

BSS

SS



LX25

GLASS SHELF



Dimensions (mm):

Width:	650
Height:	52
Projection:	127

BSS

SS



LX04

PULL HANDLE / GRAB RAIL

Dimensions (mm):

Width:	500
Height:	52
Projection:	100

Variations:

LX04-600 Width:	600
-----------------	-----

BSS

SS

DE L'EAU 316 STAINLESS STEEL



LX07



PAPER HOLDER

Dimensions (mm):

Width: 156
 Height: 52
 Projection: 90

Variations:

LX09 Hand Towel Holder

Width: 237



LX12



SINGLE TUMBLER HOLDER



Dimensions (mm):

Width: 63
 Height: 142
 Projection: 92



DE L'EAU 316 STAINLESS STEEL



LX13



SOAP DISH

Dimensions (mm):

Width:	112
Height:	62
Projection:	126

BSS
 SS



LX14

TOILET BRUSH AND HOLDER

Dimensions (mm):

Width:	78
Height:	415
Projection:	108

BSS
 SS

DE L'EAU 316 STAINLESS STEEL



LX05



TOWEL RING

Dimensions (mm):

Width:	301
Height:	301
Projection:	90



LX03



ROBE HOOK

Dimensions (mm):

Width:	50
Height:	53
Projection:	44



DE L'EAU





LW18

DOUBLE TOWEL RAIL

Dimensions (mm):
 Width: 525
 Height: 115
 Projection: 122

Variations:
LW19 Width: 675
LW20 Width: 825

CP





LW21

SINGLE TOWEL RAIL

Dimensions (mm):
 Width: 525
 Height: 78
 Projection: 90

Variations:
LW22 Width: 675
LW23 Width: 825

CP

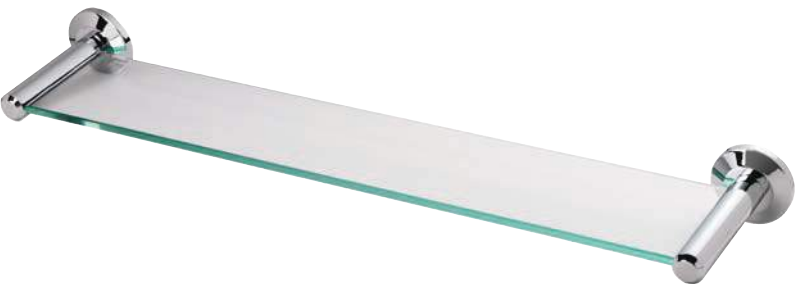



LW24

GLASS SHELF

Dimensions (mm):
 Width: 520
 Height: 50
 Projection: 100

Variations:
LW25 Width: 670
LW26 Width: 825

CP



LW05



TOWEL RING

Dimensions (mm):

Width:	182
Height:	240
Projection:	92



LW07



PAPER HOLDER

Dimensions (mm):

Width:	177
Height:	123
Projection:	50



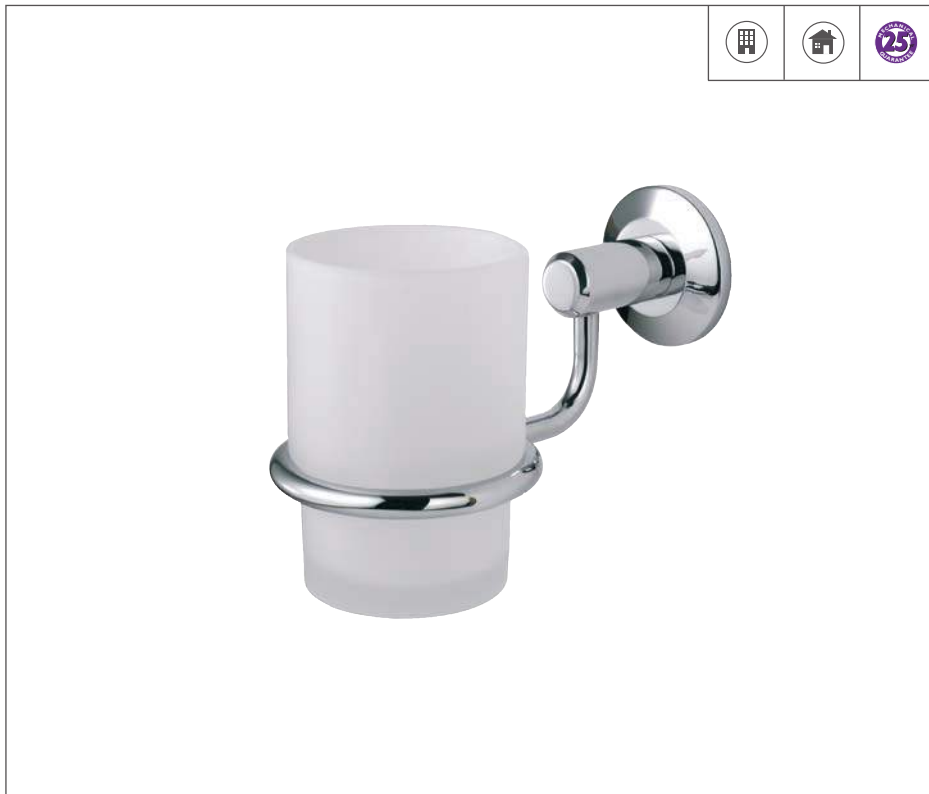

LW12

SINGLE TUMBLER HOLDER

Dimensions (mm):

Width:	77
Height:	100
Projection:	150

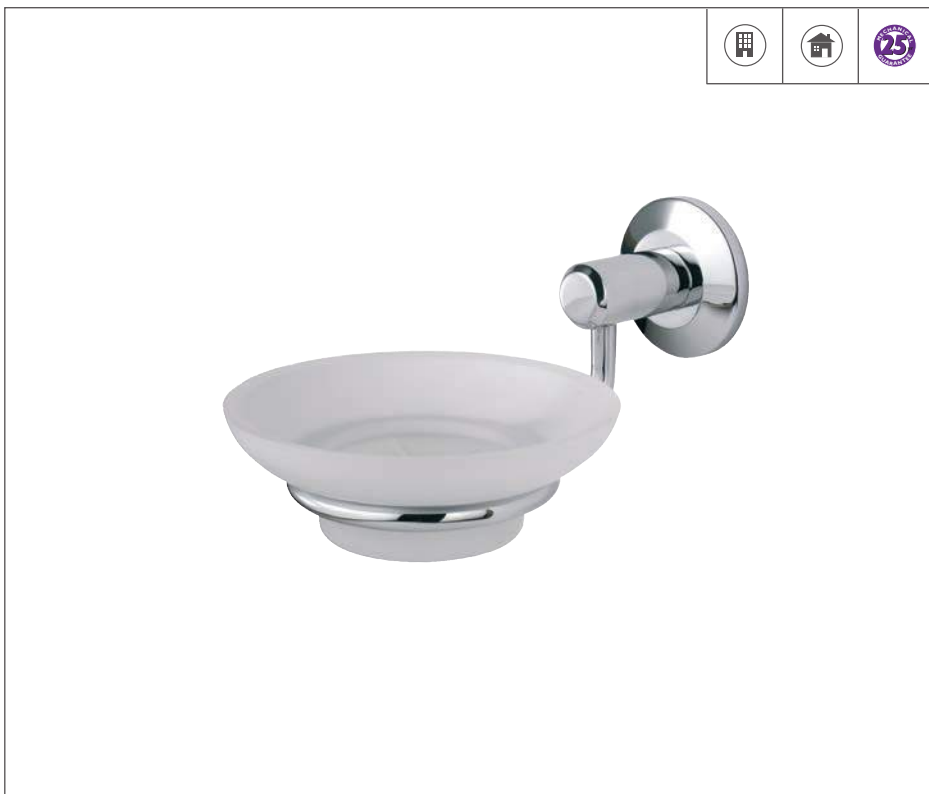

LW13

SOAP DISH AND HOLDER

Dimensions (mm):

Width:	112
Height:	82
Projection:	167





LW14

TOILET BRUSH AND HOLDER

Dimensions (mm):

Width:	116
Height:	380
Projection:	182



LW17



TRIANGULAR SOAP TRAY



Dimensions (mm):



Width:	220
Height:	66
Projection:	220



DE L'EAU

		LW02
		DOUBLE ROBE HOOK Dimensions (mm): Width: 59 Height: 62 Projection: 58  CP

		LW09
		TOOTHBRUSH HOLDER Dimensions (mm): Width: 77 Height: 72 Projection: 151  CP

		LW08
		SPARE PAPER HOLDER Dimensions (mm): Width: 76 Height: 160 Projection: 93  CP



LW27



LIQUID SOAP DISPENSER

Dimensions (mm):

Width:	77
Height:	166
Projection:	150



LW29



OVAL MIRROR



Dimensions (mm):

Width:	400
Height:	498
Projection:	18



DE L'EAU









LE18



DOUBLE TOWEL RAIL

Dimensions (mm):
 Width: 525
 Height: 123
 Projection: 102

Variations:
LE19 Width: 665
LE20 Width: 820

 CP









LE21



SINGLE TOWEL RAIL

Dimensions (mm):
 Width: 465
 Height: 87
 Projection: 106

Variations:
LE22 Width: 670
LE23 Width: 820

 CP







LE24

GLASS SHELF

Dimensions (mm):
 Width: 460
 Height: 52
 Projection: 123

Variations:
LE25 Width: 610
LE26 Width: 760

 CP



LE28

OVERHEAD TOWEL RACK

Dimensions (mm):

Width: 582
 Height: 168
 Projection: 299

CP

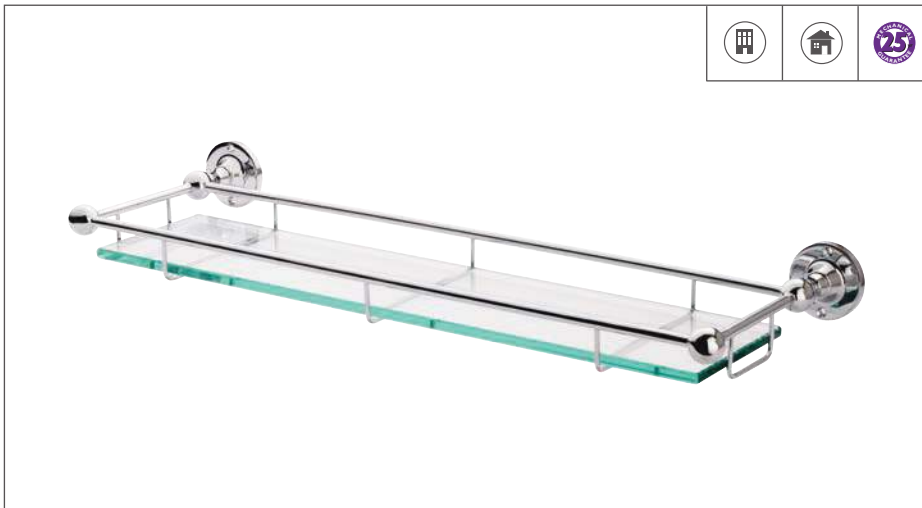

LE30

GALLERY RAIL GLASS SHELF

Dimensions (mm):

Width: 559
 Height: 59
 Projection: 163

CP



LE04



GRAB RAIL

Dimensions (mm):

Width: 513
 Height: 70
 Projection: 63

CP











LE02

DOUBLE ROBE HOOK

Dimensions (mm):
 Width: 79
 Height: 52
 Projection: 70

 CP











LE03

SINGLE ROBE HOOK

Dimensions (mm):
 Width: 52
 Height: 52
 Projection: 55

 CP



LE05

TOWEL RING

Dimensions (mm):
 Width: 169
 Height: 195
 Projection: 65

 CP



LE07



PAPER HOLDER

Dimensions (mm):

Width:	182
Height:	119
Projection:	64



CP



LE08



SPARE PAPER HOLDER

Dimensions (mm):

Width:	70
Height:	190
Projection:	98



CP



LE11



DOUBLE TUMBLER HOLDER

Dimensions (mm):

Width:	167
Height:	97
Projection:	150



CP

LE11 spare tumblers available. Contact our sales office on 01228 511030 for details.

DE L'EAU





LE12

SINGLE TUMBLER HOLDER

Dimensions (mm):

Width:	73
Height:	98
Projection:	125

CP





LE13

SOAP DISH AND HOLDER

Dimensions (mm):

Width:	157
Height:	53
Projection:	166

CP





LE09

TOOTHBRUSH HOLDER

Dimensions (mm):

Width:	107
Height:	107
Projection:	87

CP



LE06



PILLAR PAPER HOLDER

Dimensions (mm):

Width: 210
Height: 52
Projection: 80

CP



LE31



DOG BONE PAPER HOLDER

Dimensions (mm):

Width: 208
Height: 53
Projection: 78

CP



LE16



SHOWER SOAP DISH

Dimensions (mm):

Width: 192
Height: 63
Projection: 128

CP

DE L'EAU





LE17

TRIANGULAR TRAY

Dimensions (mm):

Width:	226
Height:	68
Projection:	226

CP





LE15

SPONGE HOLDER

Dimensions (mm):

Width:	277
Height:	88
Projection:	178

CP





LE14



TOILET BRUSH AND HOLDER

Dimensions (mm):

Width:	115
Height:	415
Projection:	154

CP



LV19



DOUBLE TOWEL RAIL

Dimensions (mm):

Width:	600
Height:	47
Projection:	118

CP



LV22



SINGLE TOWEL RAIL

Dimensions (mm):

Width:	600
Height:	47
Projection:	70

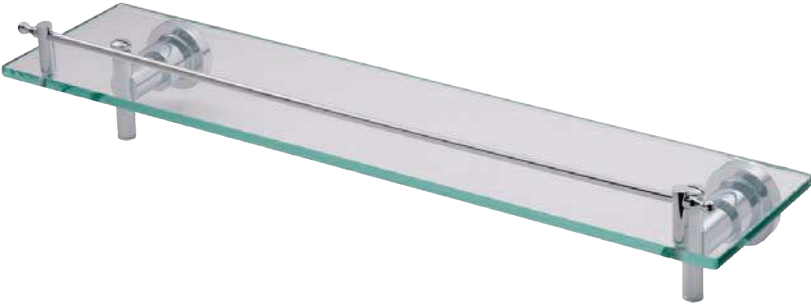
CP



LV24



GLASS SHELF



Dimensions (mm):



Width:	520
Height:	97
Projection:	126

CP

DE L'EAU

		LV02
		ROBE HOOK
Dimensions (mm): Width: 47 Height: 70 Projection: 70		
<div style="display: flex; align-items: center;"> <div style="width: 20px; height: 20px; background-color: #A9A9A9; margin-right: 5px;"></div> CP </div>		

		LV05
		TOWEL BAR
Dimensions (mm): Width: 218 Height: 54 Projection: 70		
<div style="display: flex; align-items: center;"> <div style="width: 20px; height: 20px; background-color: #A9A9A9; margin-right: 5px;"></div> CP </div>		

		LV07
		PAPER HOLDER
Dimensions (mm): Width: 175 Height: 47 Projection: 70		
<div style="display: flex; align-items: center;"> <div style="width: 20px; height: 20px; background-color: #A9A9A9; margin-right: 5px;"></div> CP </div>		



LV12



SINGLE TUMBLER HOLDER

Dimensions (mm):

Width:	127
Height:	95
Projection:	98



LV11



DOUBLE TUMBLER HOLDER

Dimensions (mm):

Width:	175
Height:	95
Projection:	98



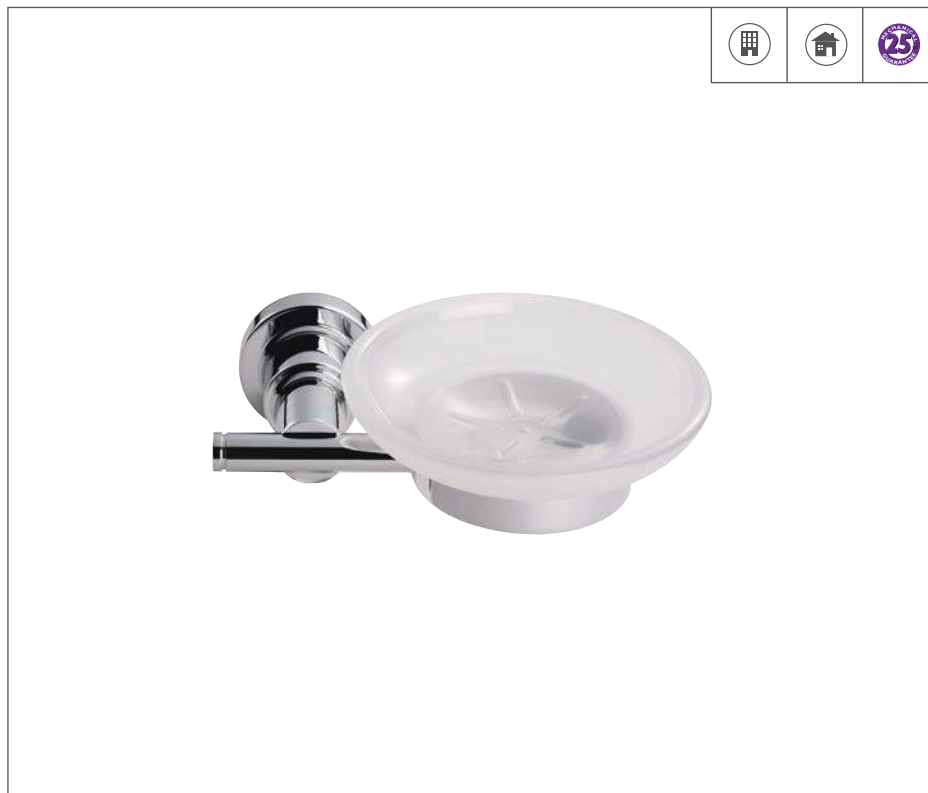

LV13

SOAP DISH AND HOLDER

Dimensions (mm):

Width: 149
Height: 50
Projection: 118



LV14

TOILET BRUSH AND HOLDER

Dimensions (mm):



Width: 165
Height: 370
Projection: 122







FINGERTIP



FTD685

BAR HANDLE

CODE				M4 ↑
FTD685C	160	180	41	25
FTD685D	192	212	41	25
FTD685E	224	244	41	25

 **SN**







FTD4215

ARIA HANDLE

CODE				M4 ↑
FTD4215C	160	200	27	25
FTD4215E	224	264	27	25
FTD4215G	320	360	27	25
FTD4215J	448	488	27	25

 **CPMSC**  **CPSN**







FTD4220

OVENCO HANDLE

CODE				M4 ↑
FTD4220C	160	240	35	25
FTD4220D	192	272	35	25
FTD4220E	224	314	35	25
FTD4220G	320	410	35	25

 **CP**  **SN**

FINGERTIP



FTD4225

SOLANO HANDLE

CODE				M4 ↑
FTD4225C	160	172	36	25
FTD4225E	224	236	36	25
FTD4225G	320	332	36	25
FTD4225J	448	460	36	25

CPMSC CPSN



FTD3170

VALETTA BOW HANDLE

CODE				M4 ↑
FTD3170A	160	184	27	25
FTD3170B	192	219	27	25
FTD3170C	320	338	29	25

CP SN



FTD3180

FULCRUM D HANDLE

CODE				M4 ↑
FTD3180A	160	183	31	25
FTD3180B	320	343	31	25

CP SN

FINGERTIP



FTD3190

SARO BOW HANDLE

CODE				M4 ↑
FTD3190A	160	182	26	25
FTD3190B	224	240	26	25

CP SN



FTD3065

SLIM D HANDLE

CODE				M4 ↑
FTD3065A	128	163	25	25
FTD3065B	160	193	26	25
FTD3065C	192	225	26	25
FTD3060D	256	288	26	25

CP SN



FTD3550

SQUARE SECTION HANDLE

CODE				M4 ↑
FTD3550B	128	143	37	25
FTD3550C	160	175	37	25
FTD3550D	192	207	37	25
FTD3550E	224	239	37	25
FTD3550F	320	335	37	25
FTD3550G	448	463	37	25

NB SN

FINGERTIP



FTD4750

BAR HANDLE

CODE				M4
FTD4750B 128	128	168	36	25 & 62
FTD4750B 160	160	200	36	25 & 62
FTD4750B 192	192	232	36	25 & 62
FTD4750B 256	256	296	36	25 & 62
FTD4750B 320	320	360	36	25 & 62
FTD4750B 448	448	488	36	25 & 62
FTD4750B 608	608	648	36	25 & 62
FTD4750B 864	864	904	36	25 & 62

SNSS



FTD480

KEYHOLE HANDLE

CODE				M4
FTD480B 160	160	184	43	25
FTD480E 256	256	280	43	25
FTD480H 352	352	376	43	25
FTD480J 448	448	472	43	25
FTD480K 608	608	632	43	25

SNSS



FTD470

KEYHOLE HANDLE

CODE				M4
FTD470B 128	128	140	32	25
FTD470C 160	160	172	32	25
FTD470D 192	192	204	32	25
FTD470E 224	224	236	32	25
FTD470J 448	448	460	32	25
FTD470L 576	576	588	32	25

CPSN

FTD4750 14mm diameter bar.
 FTD480 22mm diameter bar.
 FTD470 12mm diameter bar.



FINGERTIP







FTD685

CLEAR ACRYLIC BAR HANDLE

CODE				M4 ↑
FTD685A	96	116	41	25
FTD685B	128	148	41	25
FTD685C	160	180	41	25

 **ACC**







FTD2550

RECTANGULAR SECTION D HANDLE

CODE				M4 ↑
FTD2550B	128	136	30	25
FTD2550C	160	168	30	25
FTD2550D	192	200	30	25
FTD2550E	224	232	30	25

 **SS**







FTD335

DUO HANDLE

CODE				M4 ↑
FTD335B	128	152	34	62

 **CPMSC**

FINGERTIP

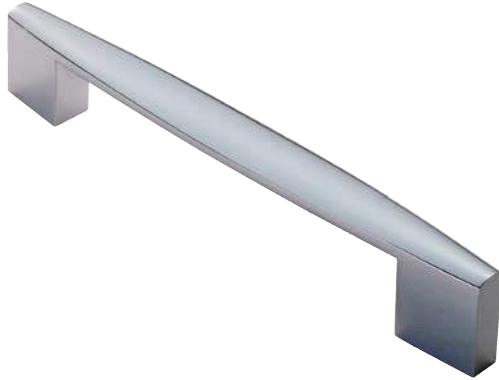

FTD2065

TAPERED END HANDLE

CODE				M4 ↑
FTD2065	160	202	32	25

CP SN



FTD3150

VENTURI D HANDLE

CODE				M4 ↑
FTD3150A	128	146	34	62
FTD3150B	160	182	37	62

CP SN



FTD2030



ANGLED END BOW HANDLE

CODE				M4 ↑
FTD2030A	128	167	30	25
FTD2030B	192	241	30	25

SN

FINGERTIP











AA100

CABINET D HANDLE

CODE	T	TT	TTI	M4 T
AA100	96	104	31	62
AA101	96	104	31	62
AA102	152	160	31	62
AA103	152	160	31	62

CP
 PB



FTD460

D HANDLE

CODE	T	TT	TTI	M4 T
FTD460A	96	106	30	62
FTD460B	128	138	30	62
FTD460C	160	170	30	62
FTD460D	192	202	30	62
FTD460E	224	234	30	62
FTD460F	288	298	30	62
FTD460G	320	330	30	62
FTD460H	352	362	30	62

CP







FTD3160

CURVA BOW HANDLE

CODE	T	TT	TTI	M4 T
FTD3160A	160	170	24	25
FTD3160B	224	238	34	25

CP
 SN



FINGERTIP



FTD2040



CONCAVE BOW HANDLE

CODE				M4 ↑
FTD2040A	128	162	24	25
FTD2040B	160	202	30	25

 CP  SN



FTD3440



SOLO HANDLE

CODE				M4 ↑
FTD3440	128	154	26	25

 SN



FTD520



SHAKER STYLE HANDLE

CODE				M4 ↑
FTD520	76	128	26	62

 CP  SB  SN

FINGERTIP



FTD2500

RECTANGULAR SECTION T-BAR HANDLE

CODE				M4 ↑
FTD2500A	128	197	30	25
FTD2500B	160	229	30	25
FTD2500C	192	260	30	25
FTD2500D	224	292	30	25

 **SS**



FTD605R

REEDED HANDLE

CODE				M4 ↑
FTD605R	128	151	39	62

 **NB**  **SN**



FTD200

CURVED HANDLE

CODE				M4 ↑
FTD200B	128	150	31	62

 **CP**  **SC**

FINGERTIP



FTD445

STEEL T-BAR HANDLE

CODE				M4 ↑
FTD445A	96	156	35	25
FTD445B	128	188	35	25
FTD445C	160	220	35	25
FTD445D	192	252	35	25
FTD445E	224	284	35	25
FTD445F	288	348	35	25
FTD445G	352	412	35	25
FTD445H	384	444	35	25
FTD445J	448	508	35	25
FTD445L	512	572	35	25
FTD445M	608	668	35	25
FTD445N	640	700	35	25
FTD445P	768	828	35	25
FTD445S	864	924	35	25
FTD445V	960	1020	35	25
FTD445W	1024	1084	35	25



FTD410

STAINLESS STEEL T-BAR HANDLE

CODE				M4 ↑
FTD410A	96	156	30	25
FTD410B	128	188	30	25
FTD410C	160	220	30	25



FTD444

MINI T-BAR HANDLE



CODE				M4 ↑
FTD444	64	100	26	25



FTD445 12mm diameter bar. FTD445V and W have centre support.
 FTD445H,L,N,P,S,V and W not available in CP or SC finish.
 FTD410 10mm diameter bar. FTD444 8mm diameter bar.



FINGERTIP



FTD250

CURVED HANDLE WITH OVAL FEET

CODE				M4 ↑
FTD250B	128	141	27	25

 SN







FTD2090

L SECTION PULL HANDLE

CODE				M4 ↑
FTD2090B	160	176	22	25
FTD2090D	224	240	22	25

 CP  SN







FTD2095

LARGE INFINITY HANDLE

CODE				M4 ↑
FTD2095E	224	264	25	25

 CP  SN

FINGERTIP



FTD2080

CHUNKY ARCHED GRIP HANDLE

CODE				M4 ↑
FTD2080A	128	155	32	25
FTD2080B	160	195	41	25

SN



FTD330

CRINKLE HANDLE

CODE				M4 ↑
FTD330B	160	175	30	62

SN NB



FTD2035



RADIUSED END FLAT BOW HANDLE

CODE				M4 ↑
FTD2035A	128	144	24	25
FTD2035B	160	173	26	25

CP SN





FINGERTIP



FTD343

PLATYPUS BOW HANDLE

CODE				
FTD343	128	166	30	25

CP
 SN







FTD2060

SHOE TREE HANDLE

CODE				
FTD2060A	128	205	28	25
FTD2060B	160	235	32	25

SN







FTD380

WAISTED FLAT BOW HANDLE

CODE				
FTD380A	96	140	23	25
FTD380B	128	182	25	25

MSN
 SN

FINGERTIP



FTD272



QUADRA BOW HANDLE

CODE				M4
FTD272B	127	161	30	25

CP SN



FTD280



WIRE PATTERN BOW HANDLE

CODE				M4
FTD280B	128	168	26	62

CP SN



FTD450



BOW HANDLE

CODE				M4
FTD450A	96	119	30	25
FTD450B	128	153	31	25
FTD450C	160	190	32	25
FTD450D	192	226	32	25
FTD450E	224	256	32	25
FTD450F	288	338	33	25
FTD450G	320	372	36	25
FTD450H	352	408	38	25



CP MSC SN

FTD450 10mm diameter bar.

FINGERTIP
CARLISLE BRASS



FINGERTIP











FTD420

STAINLESS STEEL BOW HANDLE

CODE				M4 ↑
FTD420A	96	117	30	25
FTD420B	128	150	31	25
FTD420C	160	190	32	25



 **SS**





FTD2010

WAISTED BOW HANDLE

CODE				M4 ↑
FTD2010B	128	142	28	25
FTD2010E	224	288	33	25

 **CP**
 **MSC**
 **SN**







FTD270

CURVED CONVEX GRIP HANDLE

CODE				M4 ↑
FTD270A	128	146	28	62

 **SN**

FINGERTIP



--	--	--

FTD2025

TWISTED BOW HANDLE

CODE				M4 ↑
FTD2025B	128	162	30	25

SN



--	--	--

FTD2015

FLAT TOP BOW HANDLE

CODE				M4 ↑
FTD2015B	128	153	26	25

SN



--	--	--

FTD205

WAVE PATTERN HANDLE

CODE				M4 ↑
FTD205B	128	144	22	62

CP

SC

FINGERTIP



🏢
🏠
10

FTD260

POINTED GRIP HANDLE

CODE				M4 ↑
FTD260B	128	166	33	62

CP

SN



🏢
🏠
10

FTD275

CIRCLE DESIGN CURVED HANDLE

CODE				M4 ↑
FTD275A	96	142	24	25
FTD275B	128	184	27	25

CP

SN



🏢
🏠
10

FTD230

DIMPLE EFFECT CURVED HANDLE

CODE				M4 ↑
FTD230A	96	122	27	23
FTD230B	128	156	27	23

CP

SN

FINGERTIP



FTD350

ARCOVALE HANDLE

CODE				M4 ↑
FTD350A	64	98	24	62
FTD350B	128	164	27	62



SN



FTD555

TRADITIONAL CUP HANDLE

CODE				M4 ↑
FTD555	64	104	25	62



AB

ABB

PT

SB

SN



FTD556

CUP HANDLE

CODE				M4 ↑
FTD556	64	86	25	25





CP

SN



FINGERTIP



FTD2045



CONTEMPORARY CUP HANDLE

CODE				M4 ↑
FTD2045A	96	172	18	25
FTD2045B	128	201	18	25

MSC



SN



CH84



WAVE BOW HANDLE

CODE				M4 ↑
CH84A	64	94	23	62
CH84B	96	146	25	62

CP



SC



FTD565

SHAKER HANDLE

CODE				M4 ↑
FTD565	96	130	23	25

MSC

SN

FINGERTIP



FTD377



TRUMPET KNOB

CODE				M4
FTD377	25	32	25	

SN



FTD3565



HELIO KNOB

CODE				M4
FTD3565	16	32x30	24	25

CP SN



FTD3570







ELIAS KNOB

CODE				M4
FTD3570	41x20	24	25	

CP SN

FINGERTIP





FTD4030

CRESCENT KNOB

CODE				
FTD4030	33x22	16	M4	

 CP
 SN









FTD2095

SMALL INFINITY KNOB

CODE				
FTD2095A	32	55	25	M4

 CP
 SN



FTD4040

PINCH KNOB

CODE			
FTD4040	31x18	19	M4

 CP
 SN

FINGERTIP



FTD4045

MARIN KNOB

CODE				M4 ↑
FTD4045A	38x38	21	25	



FTD4020

NOVUS KNOB

CODE				M4 ↑
FTD4020A	16	44x44	18	25



FTD4025



GAMMA KNOB

CODE				M4 ↑
FTD4025	32	48x48	23	25



FINGERTIP











CH81

SHAPED CYLINDER KNOB

CODE	Knob	Rose		M4 ↑
CH81	15 dia.	13 dia.	20	25

 **SN**











FTD2525

SQUARE KNOB

CODE	O/A		M4 ↑
FTD2525A	18x18	25	25
FTD2525B	22x22	30	25



 **CP**  **SN**





FTD600R

REEDED KNOB WITH FINIAL EARS

CODE		Rose		M4 ↑
FTD600R	70x26	26 dia.	46	62

 **NB**  **SN**

FINGERTIP



M1003

QUEEN ANNE KNOB

CODE	Knob	Rose	TTI	M4
M1003	23 dia.	25 dia.	33	25 & 62
M1004	28 dia.	30 dia.	41	25 & 62
M1005	35 dia.	38 dia.	51	25 & 62



DK47

DELAMAIN PLAIN KNOB

CODE	Knob	Rose	TTI	M4
DK47B	25 dia.	32 dia.	30	62
DK47C	30 dia.	38 dia.	36	62
DK47D	38 dia.	48 dia.	45	62

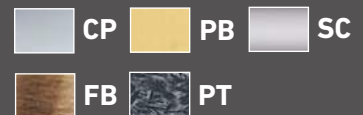

M47

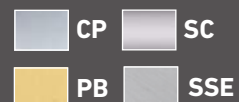

VICTORIAN KNOB

CODE	Knob	Rose	TTI	M4
M47A	25 dia.	25 dia.	25	25 & 62
M47B	32 dia.	32 dia.	32	25 & 62
M47C	38 dia.	38 dia.	38	25 & 62
M47D	42 dia.	42 dia.	42	25 & 62
M47E	50 dia.	50 dia.	48	25 & 62



FINGERTIP



FTD770



ROUND CRYSTAL KNOB

CODE	Knob	Rose	TTI	M4
FTD770C	34 dia.	18 dia.	36	25

CP

MSN



FTD790



SQUARE CRYSTAL KNOB

CODE	Knob	TTI	M4
FTD790B	32 x 32 dia.	31 dia.	25
FTD790C	38 x 38 dia.	37 dia.	25

CP

MSN



FTD670

LEAD CRYSTAL CLEAR FACETED KNOB

CODE	Knob	Rose	TTI	M4
FTD670A	25 dia.	18 dia.	36	25
FTD670B	30 dia.	21 dia.	43	25
FTD670C	35 dia.	21 dia.	45	25
FTD670D	40 dia.	23 dia.	51	25

CTB

CTC

FINGERTIP



FTD690

LEAD CRYSTAL CLEAR BALL KNOB

CODE	Knob	Rose	TTI	M4
FTD690A	27 dia.	28 dia.	40	25
FTD690B	34 dia.	28 dia.	46	25



DL47

CLASSICAL VICTORIAN KNOB

CODE	Knob	Rose	TTI	M4
DL47A	25 dia.	30 dia.	27	25 & 62
DL47B	32 dia.	37 dia.	31	25 & 62
DL47C	38 dia.	42 dia.	36	25 & 62
DL47D	45 dia.	47 dia.	42	25 & 62
DL47E	51 dia.	54 dia.	47	25 & 62



DK48

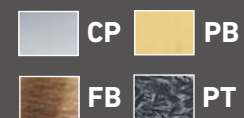

DELAMAIN FLOWER KNOB

CODE	Knob	Rose	TTI	M4
DK48B	27 dia.	32 dia.	33	62
DK48C	32 dia.	38 dia.	39	62



FINGERTIP



DK49

DELAMAIN RINGED KNOB

CODE	Knob	Rose	TTI	M4
DK49B	28 dia.	30 dia.	29	25 & 62
DK49C	35 dia.	38 dia.	36	25 & 62

CP



FB

MSC

PB

SN



FTD245

OVAL PATTERN KNOB

CODE	Knob	Rose	TTI	M4
FTD245B	34 dia.	14 dia.	32	25

SN

SC







FTD3015

HIDDEN FINGER KNOB

CODE	TTI	Slotted
FTD3015A	25x48x2	18
FTD3015B	50x48x2	18
FTD3015C	75x48x2	18

CP

SC

FINGERTIP



CH30

RINGED KNOB

CODE	Knob	Rose	TTI	M4
CH30A	17 dia.	17 dia.	18	25
CH30B	20 dia.	20 dia.	21	25
CH30C	24 dia.	24 dia.	26	25



FTD235

DIMPLE EFFECT KNOB

CODE	Knob	Rose	TTI	M4
FTD235	28 dia.	12 dia.	24	25
FTD235A	33 dia.	14 dia.	27	25



FTD255

OVAL KNOB

CODE	Knob	Rose	TTI	M4
FTD255A	37x19	11x17	22	25



FTD235 for matching handle FTD230 see P462.

FINGERTIP



CH6

BALL KNOB

CODE	Knob	Rose	T T I	M4 ↑
CH6A	18 dia.	18 dia.	21	25
CH6B	20 dia.	20 dia.	24	25
CH6C	25 dia.	25 dia.	31	25
CH6D	30 dia.	30 dia.	38	25



FTD425

STAINLESS STEEL SPHERICAL KNOB

CODE	Knob	Rose	T T I	M4 ↑
FTD425A	25 dia.	25 dia.	29	25
FTD425B	30 dia.	30 dia.	35	25



FTD345

AZTEC RINGED KNOB

CODE	Knob	Rose	T T I	M4 ↑
FTD345A	24 dia.	12 dia.	20	25
FTD345B	30 dia.	16 dia.	24	25



FINGERTIP



FTD515



TRADITIONAL PATTERN KNOB

CODE	Knob	Rose	T	M4
FTD515	34 dia.	20 dia.	2	25 & 62

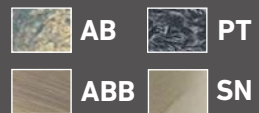

FTD125



HOLLOW VICTORIAN KNOB

CODE	Knob	Rose	T	M4
FTD1265A	25 dia.	26 dia.	28	25 & 62
FTD1265B	32 dia.	33 dia.	38	25 & 62
FTD1265C	38 dia.	36 dia.	42	25 & 62



FINGERTIP



FTD430

STAINLESS STEEL CYLINDRICAL KNOB

CODE	Knob	TTI	M4 T
FTD430A	16 dia.	21	25
FTD430B	20 dia.	24	25
FTD430C	25 dia.	30	25
FTD430D	30 dia.	38	25



FTD525

SHAKER STYLE KNOB

CODE	Knob	Rose	TTI	M4 T
FTD525A	29 dia.	16 dia.	22	25 & 62
FTD525B	35 dia.	19 dia.	26	25 & 62



FINGERTIP



FTD5595

CHEVIOT HANDLE

CODE				M4 ↑
FTD5595A	128	137	27	25
FTD5595C	224	233	27	25



FTD5625

CHILTERN HANDLE

CODE				M4 ↑
FTD5625A	128	141	29	25
FTD5625B	160	178	34	25

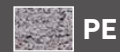

FTD5532

DIMPLED EFFECT HANDLE

CODE				M4 ↑
FTD5532	128	154	35	25



FTD5595 for matching cupboard knob FTD5590 see P488.
 FTD5625 for matching cupboard knob FTD5628 see P488.
 FTD5532 for matching cupboard knob FTD5530 see P487.



FINGERTIP







FTD5542

HAMMERED EFFECT HANDLE

CODE				M4 ↑
FTD5542	128	154	28	25

 PE





FTD1068B



FTD1064B



FTD1064/1068

HAMMERED FLEUR DE LYS HANDLE

CODE				M4 ↑
FTD1064B	68	110	36	27
FTD1068B	102	151	33	27

 BA  PE



FTD1068A

FTD1064A



FTD1064/1068

DIMPLED FLEUR DE LYS HANDLE

CODE				M4 ↑
FTD1064A	68	105	35	27
FTD1068A	102	148	39	27

 BA

FINGERTIP



FTD610



CRACKLE GLAZE PORCELAIN HANDLE

CODE				
FTD610	192	205	38	62



FTD605



CRACKLE GLAZE PORCELAIN HANDLE

CODE				
FTD605	128	151	39	62



PE5584/BW5584



GOTHIC D HANDLE

CODE				
PE5584A	81	106	29	20
PE5584B	112	150	42	20
PE5584C	175	200	50	20
BW5584A	81	106	29	20
BW5584B	112	150	42	20
BW5584C	175	200	50	20



FTD610 for matching cupboard knob FTD600/620 see P491.
 FTD605 for matching cupboard knob FTD600/620 see P491.
 PE5584/BW5584 for matching cupboard knob PE1078/BW1078 see P493.





FINGERTIP







BW5574

BEAN D HANDLE

CODE				
BW5574A	79	104	30	20
BW5574B	109	148	43	20
BW5574C	186	205	58	20





BW







FTD1250

STEEL CAGE DROP HANDLE

CODE				
FTD1250A	128	142	26	25
FTD1250B	160	181	26	25





AS





FTD1240

STEEL CAGE FIXED HANDLE

CODE				
FTD1240A	128	136	39	25
FTD1240B	160	168	39	25

AS

FINGERTIP



FTD520



SHAKER STYLE HANDLE

CODE				
FTD520	76	128	26	62

CP SB SN



FTD505



STEPPED EDGE BOW HANDLE

CODE				
FTD505	76	128	24	62

ABB AS SN



FTD510







CURVED PATTERN HANDLE

CODE				
FTD510	76	137	25	62

AB ABB PT



FINGERTIP









FTD500



CURVED PATTERN DRAWER HANDLE

CODE				M4 ↑
FTD500	76	130	23	62

AB





PT









AA100



CABINET D HANDLE

CODE				M4 ↑
AA100	96	104	31	62
AA101	96	104	31	62
AA102	152	160	31	62
AA103	152	160	31	62

CP





PB









FTD555

TRADITIONAL CUP HANDLE

CODE				M4 ↑
FTD555	64	104	25	62

AB

ABB

PT

SB

SN



FTD5515

OVAL PLATE CUP HANDLE

CODE				M4
FTD5515	85	104	26	15



FTD5520

SQUARE PLATE CUP HANDLE

CODE				M4
FTD5520	79x25	90x40	24	15



FINGERTIP

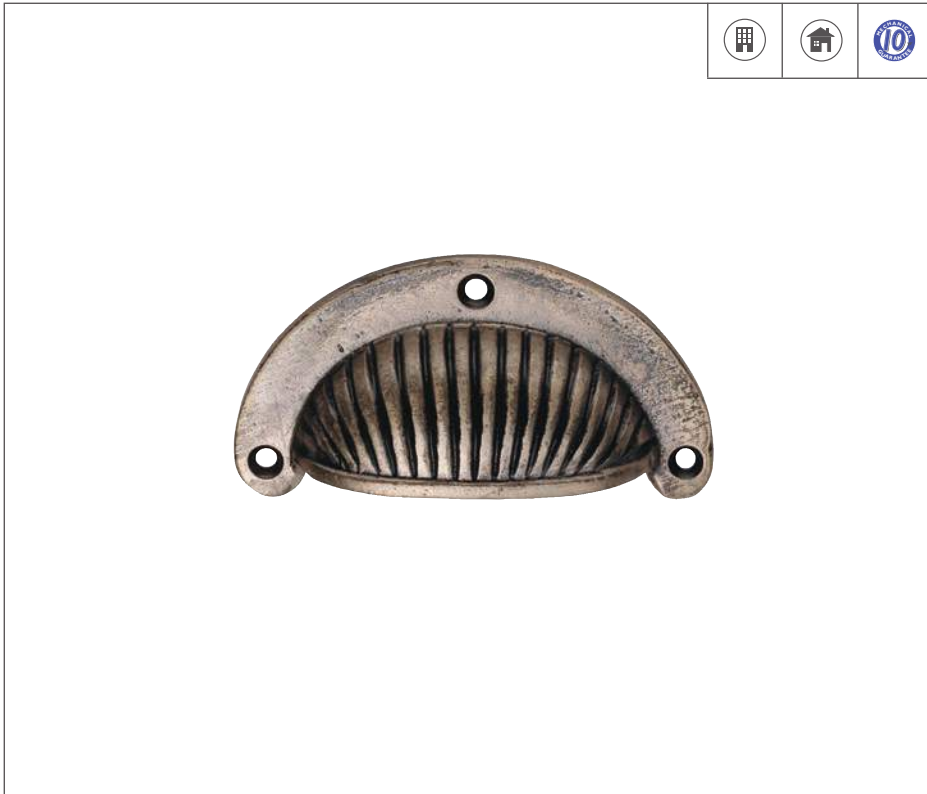

FTD5525

REEDED CUP HANDLE

CODE				M4 ↑
FTD5525	84	97	22	15

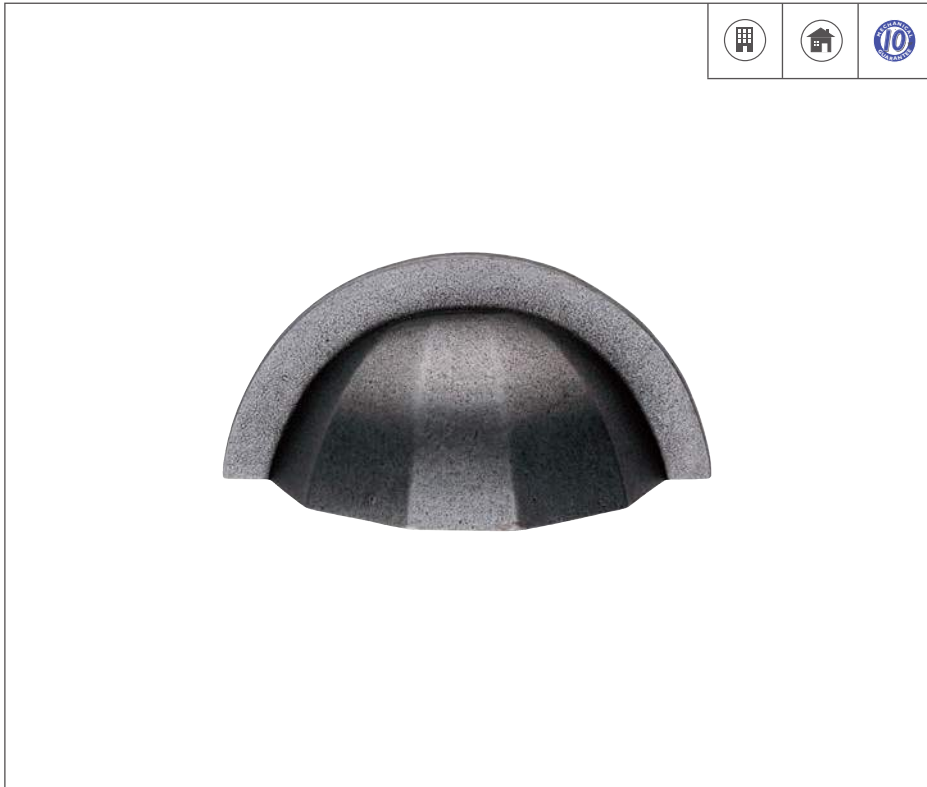

FTD5628

CHILTERN CUP HANDLE

CODE				M4 ↑
FTD5628	64	110	30	25



FINGERTIP



FTD670

LEAD CRYSTAL CLEAR FACETED KNOB

CODE	Knob	Rose		M4 ↑
FTD670A	25 dia.	18 dia.	36	25
FTD670B	30 dia.	21 dia.	43	25
FTD670C	35 dia.	21 dia.	45	25
FTD670D	40 dia.	23 dia.	51	25



FTD690

LEAD CRYSTAL CLEAR BALL KNOB

CODE	Knob	Rose		M4 ↑
FTD690A	27 dia.	28 dia.	40	25
FTD690B	34 dia.	28 dia.	46	25



M1003

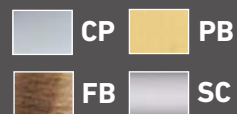

QUEEN ANNE KNOB

CODE	Knob	Rose		M4 ↑
M1003	23 dia.	25 dia.	33	25 & 62
M1004	28 dia.	30 dia.	41	25 & 62
M1005	35 dia.	38 dia.	51	25 & 62



FINGERTIP









FTD1096



HAMMERED OVAL KNOB

CODE	Knob	Rose	TTI	M4
FTD1096B	38x29	27 dia.	40	62

 BA

 PE









FTD585



HAMMERED FINISH KNOB

CODE	Knob	Rose	TTI	M4
FTD585	32 dia.	17 dia.	27	62
FTD585A	38 dia.	20 dia.	30	62

 AB

 AS



FTD1098

DIMPLED MUSHROOM KNOB

CODE	Knob	Rose	TTI	M4
FTD1098A	34 dia.	22 dia.	34	62

 BA

FINGERTIP



FTD1078



HAMMERED PATTERN BALL KNOB

CODE	Knob	Rose		M4 ↑
FTD1078A	27 dia.	36 dia.	36	62
FTD1078B	33 dia.	36 dia.	42	62



FTD5540



HAMMERED EFFECT SQUARE KNOB

CODE	Knob	Rose		M4 ↑
FTD5540	32x32	12 dia.	25	25



FTD5530



DIMPLED EFFECT SQUARE KNOB



CODE	Knob	Rose		M4 ↑
FTD5530	32x32	12 dia.	25	25



FTD5540 for matching handle FTD5542 see P478.
FTD5530 for matching handle FTD5532 see P477.

FINGERTIP



DK47

DELAMAIN PLAIN KNOB

CODE	Knob	Rose		M4 ↑
DK47B	25 dia.	32 dia.	30	62
DK47C	30 dia.	38 dia.	36	62
DK47D	38 dia.	48 dia.	45	62

CP



PB

SC

FB



PT











FTD5590

CHEVIOT KNOB

CODE			M4 ↑
FTD5590A	32	20	25



PE



FTD5620

CHILTERN KNOB

CODE			M4 ↑
FTD5620A	32	35	25
FTD5620B	38	36	25

PE

FINGERTIP



FTD1275



SOLID BRONZE COTTAGE KNOB

CODE	Knob	Rose	TTI	M4
FTD1275A	38 dia.	35 dia.	34	25



FTD1270



SOLID BRONZE MUSHROOM KNOB

CODE	Knob	Rose	TTI	M4
FTD1270A	30 dia.	19 dia.	30	25



DL47







CLASSICAL VICTORIAN KNOB

CODE	Knob	Rose	TTI	M4
DL47A	25 dia.	30 dia.	27	25 & 62
DL47B	32 dia.	37 dia.	31	25 & 62
DL47C	38 dia.	42 dia.	36	25 & 62
DL47D	45 dia.	47 dia.	42	25 & 62
DL47E	51 dia.	54 dia.	47	25 & 62



FINGERTIP













FTD1265

HOLLOW VICTORIAN KNOB

CODE	Knob	Rose	TTI	M4
FTD1265A	25 dia.	26 dia.	28	25 & 62
FTD1265B	32 dia.	33 dia.	38	25 & 62
FTD1265C	38 dia.	36 dia.	42	25 & 62

 CP
 PB
 SC











M47



VICTORIAN KNOB

CODE	Knob	Rose	TTI	M4
M47A	25 dia.	25 dia.	25	25 & 62
M47B	32 dia.	32 dia.	32	25 & 62
M47C	38 dia.	38 dia.	38	25 & 62
M47D	42 dia.	42 dia.	42	25 & 62
M47E	50 dia.	50 dia.	48	25 & 62

 CP
 SC

 PB
 SSE





CH30

RINGED KNOB

CODE	Knob	Rose	TTI	M4
CH30A	17 dia.	17 dia.	18	25
CH30B	20 dia.	20 dia.	21	25
CH30C	24 dia.	24 dia.	26	25

 CP
 PB
 SC

FINGERTIP



FTD600

CRACKLE GLAZE PORCELAIN KNOB

CODE		Rose		M4 ↑
FTD600	70x26	26 dia.	46	62

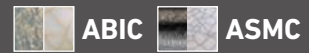

FTD620

PORCELAIN KNOB

CODE	Knob	Rose		M4 ↑
FTD620A	30 dia.	27 dia.	27	62
FTD620B	35 dia.	31 dia.	30	62
FTD620C	45 dia.	40 dia.	40	62



FTD630

PORCELAIN MUSHROOM PATTERN KNOB

CODE	Knob	Rose		M4 ↑
FTD630A	37 dia.	28 dia.	35	48
FTD630B	46 dia.	35 dia.	45	62



FINGERTIP









FTD515

TRADITIONAL PATTERN KNOB

CODE	Knob	Rose	T	I	M4
FTD515	34 dia.	20 dia.	26	25 & 62	



 **AB**

 **PT**

 **ABB**

 **SN**









FTD525

SHAKER STYLE KNOB

CODE	Knob	Rose	T	I	M4
FTD525A	29 dia.	16 dia.	22	25 & 62	
FTD525B	35 dia.	19 dia.	26	25 & 62	



 **CP**

 **SB**

 **MSC**

 **SN**









DK49

DELAMAIN RINGED KNOB

CODE	Knob	Rose	T	I	M4
DK49B	28 dia.	30 dia.	29	25 & 62	
DK49C	35 dia.	38 dia.	36	25 & 62	

 **CP**

 **MSC**

 **SN**

 **FB**

 **PB**

FINGERTIP



PE1078

CUPBOARD KNOB

CODE			M4
PE1078A	22	21	25
PE1078B	30	25	25
PE1078C	40	34	25



DK48

DELAMAIN FLOWER KNOB

CODE	Knob	Rose		M4
DK48B	27 dia.	32 dia.	33	62
DK48C	32 dia.	38 dia.	39	62

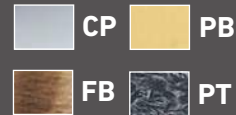

BW1078

BEATEN KNOB



CODE			M4
BW1078A	22	21	25
BW1078B	30	25	25
BW1078C	40	34	25



PE1078 for matching handle PE5584 see P479. BW1078 for matching handle BW5584 see P479.

FINGERTIP











FTD1210

STEEL CAGE BALL KNOB

CODE	Knob	Rose		M4 ↑
FTD1210A	34 dia.	12 dia.	56	25
FTD1210B	42 dia.	14 dia.	60	25

 AS











FTD1220

STEEL CAGE MUSHROOM KNOB

CODE	Knob	Rose		M4 ↑
FTD1220A	34 dia.	12 dia.	31	25
FTD1220B	44 dia.	14 dia.	40	25



 AS



FTD1230

STEEL CAGE OVAL KNOB

CODE		Rose		M4 ↑
FTD1230A	55	12 dia.	33	25
FTD1230B	65	14 dia.	35	25

 AS

FINGERTIP



FTD540

CELTIC PATTERN KNOB

CODE	Knob	Rose	TTI	M4
FTD540	30 dia.	14 dia.	25	25



FTD575

STEEL CAGE KNOB

CODE	TTI	Rose	TTI	M4
FTD575	124	20 dia.	53	62



FTD1096

OVAL KNOB

CODE	Knob	Rose	TTI	M4
FTD1096A	38x28	26 dia.	39	25
FTD1096B	38x28	26 dia.	39	25



FTD1096A = Smooth Finish
 FTD1096B = Hammered Finish



FTD1096A not available in PE finish.



FINGERTIP











FTD1044

RING PULL ON GOTHIC CROSS BACKPLATE

CODE		Pull		M4 ↑
FTD1044	57x57	42 dia.	23	25

 BA













FTD1078

HAMMERED PATTERN BALL KNOB

CODE	Knob	Rose		M4 ↑
FTD1078A	27 dia.	37 dia.	36	62
FTD1078B	32 dia.	37 dia.	42	62



 BA  PE



FTD5620

HAMMERED BALL KNOB ON BACKPLATE

CODE	Knob	Rose		Slotted 	M4 ↑
FTD1074A	63x63	27 dia.	38	22	62
FTD1074B	63x63	32 dia.	43	22	62

 BA

FINGERTIP



FTD815

DOUBLE BALL CATCH

CODE	L x W x H
FTD815A	43x8
FTD815B	50x9.3
FTD815C	60x11.5
FTD815D	70x13.5

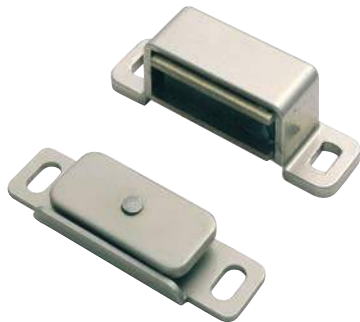

FTD840/850

SUPERIOR STEEL MAGNETIC CATCH

CODE	L x W x H	
FTD840	46x15x14	6.0Kg pull
FTD850	46x15x14	3.5Kg pull



FTD820

PREMIUM CABINET BUTT HINGE

CODE	L x W x H
FTD820D	64x35x2



FINGERTIP







FTD810

BRASS H PATTERN HINGE

CODE	L x W x H
FTD810	63x38x2.5

 AB
 POL/LAC







FTD805

FINIAL CABINET HINGE

CODE	L x W x H
FTD805C	50x28x1.5
FTD805D	64x35x2

Add 6mm to either end for finial ends.

 AB
 PB
 SC







FTD800

CABINET HINGE

CODE	L x W x H
FTD800C	50x28x1.5
FTD800D	64x35x2

 AB
 PB
 SCOL

 CP
 SC

FINGERTIP



FTD855

HEAVY PATTERN CABLE TIDY

CODE	Insert	TTI
FTD855	60mm	20

CP EB SN



WF13

T HANDLE FASTENER

CODE	Insert	Slotted T
WF13	57x19	23

CP PB SC



H4.170.35

SOFT CLOSE HINGE

CODE	
H4.170.35.10	170 degree soft close Hinge

NP

FINGERTIP



H4.100.35

SOFT CLOSE HINGE

CODE

- H4.100.35.30
Inset Soft Close Hinge
- H4.100.35.20
Half Overlay Soft Close Hinge
- H4.100.35.10
Full Overlay Soft Close Hinge

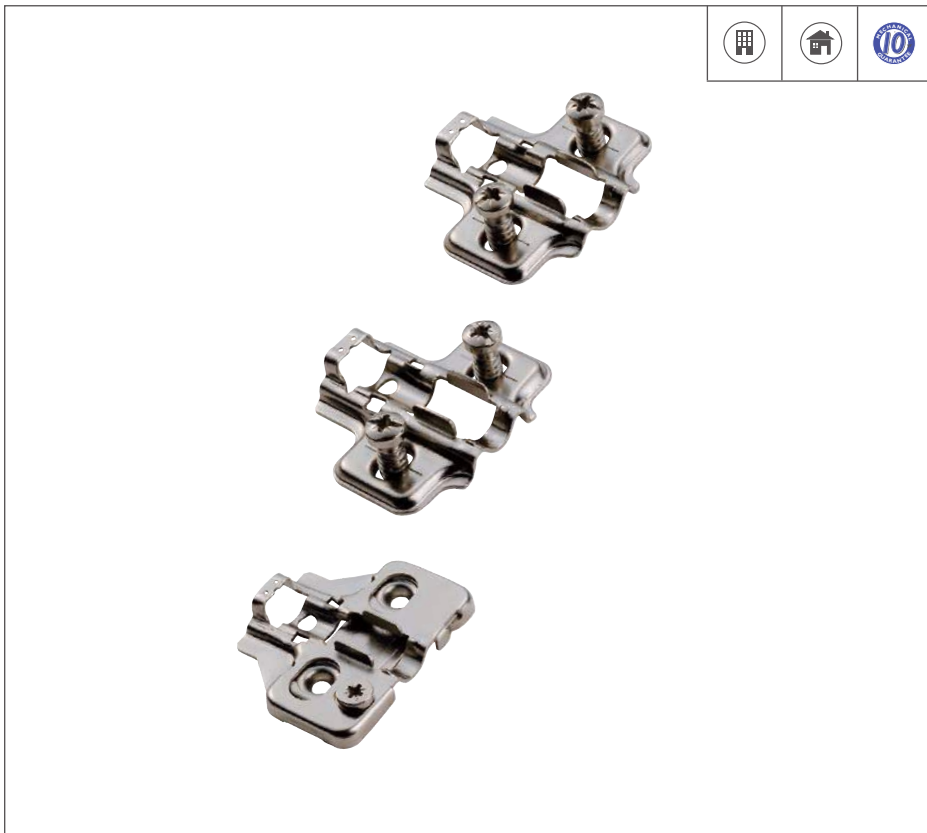

P4.100.35























MOUNTING PLATE























CODE

- P4.100.35.00
Mounting Plate
- P4.100.35.02
Mounting Plate
- P4.100.35.A00
Adjustable Plate







































KEY TO FINISHES

	AB - Antique Brass
	ABB - Antique Burnished Brass
	ABIC - Antique Brass/Ivory Crackle Glaze
	ACC - Acrylic Clear Chrome
	AS - Antique Steel
	ASMC - Antique Steel/ Midnight Blue Crackle Glaze
	BA - Black Antique
	BEP - Black Electro Plated
	BLACK - Black
	BL - Black
	BLK - Black
	BN - Black Nickel
	BR - Brown
	BR000 - Bronze Plated
	BROWN - Brown
	BSS - Bright Stainless Steel
	BSS/SSS Bright Stainless Steel/ Satin Stainless Steel
	BW - Beeswax
	BZP - Bright Zinc Plated
	CP - Polished Chrome
	CPMC - Polished Chrome/Matt Chrome
	CPMSC - Polished Chrome/ Matt Satin Chrome

	CPSC - Polished Chrome/Satin Chrome
	CPSN - Polished Chrome/Satin Nickel
	CPWH - Polished Chrome/White
	CTB - Clear Translucent Brass
	CTC - Clear Translucent Chrome
	DB - Dark Bronze
	EB - Electro Brassed
	FB - Florentine Bronze
	FBIC - Florentine Bronze/ Ivory Crackle Glaze
	GAA - Gold Anodised Aluminium
	GALV - Galvanised
	GN - Green
	GOLD - Gold
	IC - Ivory Crackle Glaze
	ICFB - Ivory Crackle Glaze/ Florentine Bronze
	JAP - Black Japaned
	MC - Matt Chrome
	MCCP - Midnight Blue Crackle/ Polished Chrome
	MSC - Matt Satin Chrome
	MSN - Matt Satin Nickel
	NB - Black Nickel
	NIK00 - Nickel Plated

KEY TO FINISHES

	NP - Nickel Plated
	OTT00 - Brass Plated
	PAA - Polished Anodised Aluminium
	PB - Polished Brass
	PBKCP - Porcelain Black/ Polished Chrome
	PC - Polished Chrome
	PCB - Powder Coat Black
	PCSC - Polished Chrome/Satin Chrome
	PE - Pewter
	PG - Polished Gold
	PIV - Porcelain Ivory
	PLW - Plain White/Polished Brass
	PLWCP - Plain White/Polished Chrome
	PNP - Polished Nickel Plated
	PNSN - Polished Nickel/Satin Nickel
	POL/LAC - Polished/Lacquered
	PS - Polished Stainless
	PT - Pewter
	PVD - Stainless Brass
	PWH - White Porcelain
	PWSC - White Porcelain/Satin Chrome
	SAA - Satin Anodised Aluminium
	SB - Satin Brass
	SBPB - Satin Brass/Polished Brass

	SC - Satin Chrome
	SCCP - Satin Chrome/Polished Chrome
	SCOL - Self Colour
	SN - Satin Nickel
	SNP - Satin Nickel Plated
	SNSS - Satin Nickel/Stainless Steel
	SS - Stainless Steel
	SSCP - Stainless Steel/Polished Chrome
	SSE - Stainless Steel Effect
	SSS - Satin Stainless Steel
	SSSC - Satin Stainless Steel/ Satin Chrome
	SV - Silver
	SZP - Satin Zinc Plate
	VCH00 - Stainless Steel Plated
	WHITE - White
	WHT - White
	W - White
	WWPB - Wood Walnut/Polished Brass
	WOSC - Wood Oak/Satin Chrome
	ZP - Zinc Plate

KEY TO SYMBOLS

Suitable Environments For Use:



Industrial



Commercial



Domestic

Guarantees:



2 Year
Electrical



2 Year
Mechanical



5 Year
Mechanical



10 Year
Mechanical



25 Year
Mechanical



BS 8300 is the design of buildings and their approaches to meet the needs of disabled people.



CE MARKING is certification to the highest levels of attestation required by the Construction Products Directive. The CE mark indicates that the product has been successfully 3rd party performance/fire tested and that the producing factory has passed stringent Factory Production Control audits, carried out by a UKAS notified certification.



APPROVED PRODUCT
CFXXX

CERTIFIRE is an independent 3rd party scheme providing high quality, voluntary, product conformity for the passive fire sector. Certifire is product certification at a higher level than CE. Additional requirements are ISO:9001:2000 certification, independent audit testing and a comprehensive field of application document based on carefully chosen tests. Designed to give confidence to specifiers, enforcement authorities and building owners/occupiers, the Certifire scheme is recognised by regulatory authorities both in the UK and overseas.



BS 3621

KITEMARK is the world's premier symbol of trust, integrity and quality. Manufacturers having this associated with their product or service will reassure customers and specifiers alike that they have satisfied the most rigorous of quality processes.



TS 007:2015
KM 585549

TS 007:2015 is the Kite-marked security standard for replacement lock cylinders and protective door furniture. A technical specification created for the industry in response to growing concerns that domestic homes are under threat from attack due to readily available information on the internet.

BS EN 1634 is the European Fire Safety Standard for determining the fire resistance of door and shutter assemblies, including door hardware:



FD30

FD30 30 minute fire doors



FD30/60/120

FD30/60/120 30/60/120 minute fire doors



FD60

FD60 60 minute fire doors



FD120/240

FD120/240 120/240 minute steel fire doors

KEY TO SYMBOLS



BS EN 179

BS EN 179 is the British/European standard requirements and testing methods covering panic exit devices operated by a lever handle or push pad.



BS EN 1125

BS EN 1125 is the British/European standard requirements and testing methods covering panic exit devices operated by a horizontal bar.



BS EN 1154

BS EN 1154 is the British/European standard requirements and testing methods covering controlled door closing devices.



BS EN 1155

BS EN 1155 is the British/European standard requirements and testing methods covering electronically powered hold open devices.



BS EN 1303

BS EN 1303 is the British/European standard requirements and testing methods covering cylinders for locks.



BS EN 1670

BS EN 1670 is the British/European standard requirements and testing methods covering corrosion resistance.



BS EN 1906

BS EN 1906 is the British/European standard requirements and testing methods covering lever handles and knob furniture.



BS EN 1935

BS EN 1935 is the British/European standard requirements and testing methods covering single axis hinges.



BS EN 12209

BS EN 12209 is the British/European standard requirements and testing methods covering locks, latches and locking plates.

KEY TO SYMBOLS



SECURED BY DESIGN is the UK policed flagship initiative supporting the principles of “designing out crime” prevention and security standards for a range of applications and products showing their logo have met the standards identified by this organisation. A full list of licensed products can be found on the website www.securedbydesign.com

CYLINDERS FEATURES AND BENEFITS



Anti-Drill



Break-Off System



Anti-Plug Pull



Anti-Pick



Anti-Bump

INTUMESCENT FEATURES AND BENEFITS



37Rw dB

Acoustically Tested



SMOKE

Smokeproof



CARE INSTRUCTIONS

BEESWAX

The combination of hand forged metal finished with wax. Due to the simplicity, the finish is essentially everlasting as long as it is maintained correctly with Carlisle Brass wax. Sometimes because of temperature changes your product may have a slight white bloom, we recommend that you polish it with a soft cloth and a small amount of maintenance wax to restore the finish. If your product is fitted in a damp area such as a bathroom it may have the potential to exhibit surface rust. If this occurs we recommend that the product is cleaned with fine wire wool and Carlisle Brass maintenance wax is applied to restore the finish. The use of maintenance wax is necessary to restore finish and afford protection to the beeswax range of products. If surface rust occurs then simply rub the affected area with wire wool and apply the maintenance wax with a rag or brush. It is important to note that where mechanical parts come together and there is abrasive movement, the wax surface will eventually be lost. We recommend that you oil these moving parts occasionally NB: there may be very slight colour or size differences with these products as every item is hand forged. Where this would be a problem with other ironmongery products we feel it enhances the appeal of this range.

BLACK ANTIQUE

Iron in any form, whether cast or malleable, is susceptible to rusting. During our finishing process we make every effort to cover all areas of our black ironmongery with an epoxy coating. They are first pre baked to approximately 1500C before receiving a spray coating, then finally baked in an electric oven at approximately 2000C. Unavoidably when two areas of metal come into contact with each other an abrasive action is enacted, and eventually the painted surfaces are lost by the continuous rubbing action. This is inevitable during the operational activity of the item, so where obvious abrasive areas of moving parts are visible an occasional light oiling is recommended. This will help to prolong the aesthetic appearance and keep the rusting process at bay. To remove harmful deposits which will cause corrosion (this is even more critical near to a coastline, as the salt air has a very corrosive effect on iron) we advise that the ironmongery is regularly wiped over with a lightly oiled cloth.

BRASS

Our brass products are protected by the most advanced lacquer available and under normal circumstances should give many years of service. They should be cleaned with a cloth moistened with soapy water or alternatively wiped over with a soft cloth with beeswax. **UNDER NO CIRCUMSTANCES USE ANY FORM OF METAL CLEANER OR AEROSOL SPRAYS.** However, after a period of time the lacquer coating, especially on external fittings, can suffer a possible breakdown. Therefore, the life of the lacquer is beyond the manufacturer's control and cannot be guaranteed. When the lacquer coating has broken down, remove the brass fittings and coat using a soft brush with acetone thinner e.g. 'Nitramores' according to the manufacturer's instructions. Completely dry the product using a soft cloth and metal polish, such as "Brasso" or 'Duraglit'. At this stage the product can either be re-lacquered or polished as and when required. A fresh coat of lacquer may be applied, but we strongly recommend that, especially for external use, you should leave the item unlacquered.

CHROME

Our chrome products are virtually maintenance free. However, deposits will accumulate especially on external fittings. We therefore recommend regular cleaning with a soft cloth and non-abrasive wax polish.

PEWTER

This finish is extremely durable both internally and externally. Pewter finish is electro plated and then stove lacquered and requires no more than an occasional wipe with a damp cloth and some soapy water.

STAINLESS BRASS PVD

These products have an advanced vacuum treated process and we can offer a full 25 year replacement guarantee with the exclusive stainless brass finish. The technology involved in this process renders this surface impervious to damage in normal use including oxidation, wear and abrasion. We recommend the removal of surface dirt by dusting with a soft cloth. Stubborn stains can be removed with the use of white spirit or similar based products.

STAINLESS STEEL

Stainless steel is protected from corrosion by a thin layer of chromium oxide. Oxygen from the atmosphere combines with the chromium in the stainless steel to form this passive chromium oxide film that protects from further corrosion. Any contamination of the surface by dirt, or other material hinders this passivation process and traps corrosive agents, reducing corrosion protection. Thus some form of routine cleaning is necessary to preserve the appearance and integrity of the surface. Stainless steels are easily cleaned by many different methods. They actually thrive with frequent cleaning and, unlike some other materials, it is possible to 'wear out' stainless steel by excessive cleaning. Cleanliness is essential for maximum resistance to corrosion. All exposed stainless steel surfaces should be wiped over with a clean cloth and warm water with a mild detergent on a frequent and routine basis. For more stubborn dirt or stains use mild, non-scratching abrading powders such as typical household cleaners. These can be used with warm water, bristle brushes, sponges or clean cloths. For more aggressive cleaning a small amount of vinegar can be added to the powder. Carbon steel brushes and steel wool should be avoided as they may leave particles embedded in the surface, which can lead to rusting. Cleaning should always be immediately followed by rinsing in clean hot water and the surface then wiped completely with a dry towel. The maximum recommendation for routine cleaning is once a month and more often in areas subject to heavy soiling or frequent use.

Where routine maintenance is considered a prerequisite of compliance with an associated guarantee a 'Maintenance Log' should be kept for each installation.

INDEX

183876	300
1838100	300
AA1	38/51
AA100	452/482
AA12	39/51
AA122	226
AA12L	39/51
AA133	222
AA133BA	270
AA145	120/155
AA14A-B	52
AA15	138
AA16A-C	53
AA19	53/138
AA2	38/51
AA20	227
AA21	226
AA22	226
AA23	226
AA25	224
AA26	224
AA27	224
AA3	38/51
AA30	178
AA31	178
AA32	223
AA33	222
AA33BA	270
AA34	229
AA345	120
AA345	155
AA35	229
AA36	139
AA36L	139
AA38	225
AA39	419
AA4	219
AA40	418
AA40LCK	418
AA41	419
AA42	420
AA42R	420
AA42RI	420
AA45/AA45R	324
AA52	164
AA53	164
AA54	164
AA55BA	257
AA56	164
AA60	223
AA61	223
AA62	223
AA63	223
AA64	223
AA65	223
AA73	412
AA75	178
AA76	179
AA77	179
AA79	227
AA80	233
AA81	233

AA810	233
AA812	233
AA813	228
AA818	233
AA824	233
AA84	225
AA85	226
AA86	225
AA90	139
AA91	139
AA92	140
AA93	140
AA95	140
AA96/AA97	413
AC010	182
AC011	182
AC013	183
AC020	183
AC033	184
AC050	150
AC055	168
AEIL5000	369
AKSFB2	406
AQ1	45
AQ11	39/52
AQ12	39/51
AQ133	156
AQ1NP	159
AQ1NP92	159
AQ2	45
AQ25	225
AQ2NP	159
AQ2NP92	159
AQ3	45
AQ31	179
AQ34	150
AQ35	151
AQ39	418
AQ4	46
AQ40	179
AQ41	155/180/191
AQ42	420
AQ43	418
AQ45	219
AQ46	228
AQ47	228
AQ5	46
AQ50	421
AQ8	46
AQ81	232
AQ82	232
AQ82EX	232
AQ83	232
AQ84	232
AQ90	221
AQ91	421
AQ92	422
AQ93	422
AQ96	422
ART55B	54
ART55BQ	54
ART56	54

ART84	55
ART85B	55
ARTFT	56
ARTFTS	56
B12	121
B12	157
BAE5025-30	385
BAS5025-30	396
BB3204-3808	233
BBT1080	244
BBT1080CR	245
BBT1100	244
BBT1100CR	245
BBT1150	244
BBT1150CR	245
BBT1200	244
BBT1200CR	245
BBT4100	202
BBT4100CR	202
BBT4150	202
BBT4150CR	202
BBT4200	202
BCP1000	116
BCP9000	211
BR35	228
BL1-4	388
BTL1-4	389
BW1006LH/RH	284
BW1078	493
BW1078A-C	283
BW34LH/RH	283
BW5501-06	275
BW5515A-E	276
BW5520A-E	276
BW5526	282
BW5527-28	281
BW5529	282
BW5530A-B	280
BW5535	277
BW5540A-C	284
BW5541A-C	284
BW5545	277
BW5546C/O	285
BW63A-B	280
BW5564A-B	279
BW5565A-B	279
BW5574	480
BW5574A-C	278
BW5575C	278
BW5584A-C	278
BW5594	285
CAB1100	238
CB100-175	351
CDC85/R	324
CDG003	324
CEB001-4Q	42
CEB010Q	41
CEB020Q	41
CEN030Q	41
CEN1433-43/13	311
CFD1150-1600	87
CFPT1450-1600	87

CH6	474
CH30	473/490
CH81	468
CH84	464
C1001129-31	321-322
CL155SGVCB	406
CPD1096-1128	245
CPM1096-1128	245
CPRB1170	97
CPRE1170/72	97
CPRP1170	97
CPRT1170/78	97
CPRTL1170/78	97
CPRU1170	97
CPSB1170	97
CPSE1170/72	97
CPSP1170	97
CPST1170/78	97
CPSTL1170/78	97
CPSU1170	97
CSD1150-1600	87
CSE1005	61
CSK1058	105
CSL1121-34	58
CSL1160-91	59
CSL1192-94	60
CSL1195	61
CSL1220	59
CSLP1162B-T	99
CSLP1163B-T	99
CSLP1164B-T	100
CSLP1167B-T	100
CSLP1190-91	96
CSP1005	61
CSR1005	87
CST1015	61
CST1025/K	62
CSU1005	61
CYA70445-470	368
CYA71130SC/C	367
CYA71130SC/O	367
CYA71140-71290	362
CYA713100-71370	364
CYA71370/2	363
CYA71370/73520	363
CYA71380-72150	364
CYA72260-72380	365
CYA73520	366
CYA73620/2	366
CYE71140-71290	358
CYE7133040-72145	359
CYE72260-72370	360
CYE73520	361
CYF73524	371
CYF73624	372
CYH71142-71290	373
CYH713100-71390	374
CYH72142-72280	375
CYH72364-72380	376
CYH72-SO31	376
CYH72-SP31/31	376
CYH73525	378

CYH7PLC55	367/377
CYH7PL047	367/377
CYP71141-71282	379
CYP71362-73526	380
CYX71146-71290	370
CYX713100-71390	371
CYZ500-800	381-382
DA5	47
DB8-24	231
DCC2003CF	336
DCC2003SM	333
DCC2024CF	335
DCC2024CF/36	337
DCC2024SM	332
DCC2024SM/36	334
DCCEM3024	342
DCEM2003	342
DCEM2004	343
DCF2003	325/331
DCF2003FCP	325/330
DCFS150/EN3	340
DCFS250/EN4	341
DGP3000	332/338
DGP3202/36	334/338
DGP3202	333/338
DCS2024/DCS2024BC	327/330/331
DCS2025BC	328/330
DCS2025BCDA	328/331
DCS2025BC/FCP	328/330
DCS2025BCDA/FCP	328/330
DCS2026BC	329/331
DCS2026BCDA	329/331
DCS2026BC/FCP	329/330
DCS2026BCDA/FCP	329/330
DCT2024/DCT2024BC	326
DCT2024/FCP	326/330/331
DCT2024BC/FCP	326/330
DCT2024BCDA/FCP	328/330
DCT2026BCDA/FCP	330
DCTS100EN3/150EN4	341
DCX2002	339
DCX2003	340
DCX2107	331
DCX2201/02/03	331
DCX3202/DCX3202/36	339
DEFB100	343
DEM100F/S	344
DK1	156/191
DK12	157/192
DK13	157/192
DK3	156/191
DK32	184-185
DK34	185-187
DK35/C	187-188
DK36C	188
DK37C	189
DK39C	189
DK4	220
DK42	419
DK45	235
DK47	469/488
DK48	471-493

DK49	472-492
DK6	220
DK7	413
DK8	413
DL100	128
DL100B	191
DL100WC	128
DL102	128
DL16-18	123
DL160-162	130
DL166-168	126
DL180-182	131
DL19	164
DL190-192	131
DL20	146
DL219	169
DL250B-262B	190
DL263-272	129
DL290-292	131
DL30-31	123
DL300-302	126
DL340-346	132
DL350-352	132
DL380-382	131
DL410-412	133
DL450-452	133
DL460-462	130
DL47	471-489
DL5025-50	399
DL54-55	124
DL56	119
DL611	141
DL64-65	124
DL66	119
DL67-68	125
DL75-76	125
DLD5030-50	399
DLE0055EP/L	392
DLE7255EP/L	392/393
DLE7855	393
DLS0060EP/L	402
DLS7260EP	402
DLS7260ESC/NLA	403
DLS7860WC	403
DND001-4/DND001-4Q	44
DND010-030	43
DR5F	47
DSB8225/L	229/387
DSF1030-32	242-243
DSF2020-3020	227
DSF4032	201
DSF5020	227
DSF9030-32	213-214
DSK8000	229
DSK8000B/L	387
DSW1015-17	243-244
DSW6001	201
DSW9015	213
EBH1-3	300
ECP1000	116
ECP4000	200
ECP9000	212

INDEX

EDB5025-30/CT	404-405
EDE5025-30	384
EDS5025-30	395
EL11-13	134
EL21-23	134
EL31-33	135
EL41-43	135
EL5	47
EL60-62	136
ES1200-1227	352
ES1238-1405	351
ES300-309	355
ES34-35	230
ES400-424	356
ES600-601	353
ES800-803	354
ES804	353
ES805-808	354
ES901-903	355
ESB5025-30/CT	405
ESE1005	85
ESE4005	196
ESE5025-30	384
ESE9005	210
ESP4005	196
ESP9005	210
ESS5025-30	395
EST4005/4025	196
EST9005/9025	210
EST9625	211
ESU4005	196
ESU9005	210
FBH1-2	300
FBT1008/R	244
FBT4006-10	203
FG1	129
FG10	146
FG11B	173
FG15	169
FG1WC	129
FG1-2	129
FG26-27	130
FG4	151
FG7B-S	165
FG8C	172
FG8XL	173
FG9	180
FH5	48
FIX4019	197
FIX9005	209
FLD8025-40	397
FLE8030	398
FLL5025-40	397
FPA1301-2	114
FPA4301-2	199
FPH1000-2	237
FPH1003-4	238
FPH4100	201
FPP1300-1650	104-105
FPP43000-46502	197-198
FR5F	48
FRP50-63	235

FTD1064/1068	478
FTD1078	487/496
FTD1096	486/495
FTD1098	486
FTD1210-30	494
FTD1240	480
FTD125	475
FTD1250	480
FTD1265	490
FTD1270-75	489
FTD200	454
FTD2010	460
FTD2015-25	461
FTD2030	451
FTD2035	457
FTD2040	453
FTD2045	464
FTD205	461
FTD2060	458
FTD2065	451
FTD2080	457
FTD2090	456
FTD2095	456
FTD2095	466
FTD230	462
FTD235	473
FTD245	472
FTD250	456
FTD2500	454
FTD2525	468
FTD255	473
FTD2550	450
FTD260	462
FTD270	460
FTD272	459
FTD275	462
FTD280	459
FTD3015	472
FTD3065	448
FTD3150	451
FTD3160	452
FTD3170-80	447
FTD3190	448
FTD330	457
FTD335	450
FTD343	458
FTD3440	453
FTD345	474
FTD350	463
FTD3550	448
FTD3565-377	465
FTD380	458
FTD4020-25	467
FTD4030-40	466
FTD4045	467
FTD410	455
FTD420	460
FTD4215-20	446
FTD4225	447
FTD425	474
FTD430	476
FTD444-445	455

FTD450	459
FTD460	452
FTD470	449
FTD470-480	449
FTD500	482
FTD505-510	481
FTD515	475/492
FTD520	453/481
FTD525	476/492
FTD540	495
FTD5515-20	483
FTD5525	484
FTD5530	487
FTD5532	477
FTD5540	487
FTD5542	478
FTD555	463/482
FTD556	463
FTD5590	488
FTD5595	477
FTD5620	488/496
FTD5625	477
FTD5628	484
FTD565	464
FTD575	495
FTD585	486
FTD600	491
FTD600R	468
FTD605	479
FTD605R	454
FTD610	479
FTD620-30	491
FTD670	470-485
FTD685	446/450
FTD690	471/485
FTD770-790	470
FTD800-810	498
FTD815-850	497
FTD855	499
GI5	48
H2N11015/13	314
H2N1102/13-H2N1103/13	315
H2N1121/14	316
H2N1202/11	313
H2N1424-46	316
H2N1502/13	314
H2N1503/11	313
H2N1900-1950	320
H3N1101/11	317
H3N1102	318
H3N1102A/13	319
H3N1105/11	317
H3N1107/13	318
H4.100.35	500
H4.170.35	499
HBS1038-50	242
HCH1010-18	239-241
HCH9012-13	215
HDBB1-4	304
HDPBW4-61	302
HDSSW2-5	303
HDSW1-20	303

HIN1322	305
HIN13225/11	309
HIN14325/13	310
HIN1433/13	309
HIN1433HT/13	312
HIN1433P/13	310
HIN1433SEC	312
HIN3424	308
HINFP1-4	271/301
HINLP1-4	301
HIP1332	306
HIP13225/7	308
HIP14325/7	308
HIW13215-14325	307
HL3-6	234
HM3-6	234
HRB1000/P62-HRB1000/P85	242
HSD3-4	302
INT1008-2500	319/353
KPP1590-1915	113
LCP1000	398
LDB5525-30	404
LDE5325	386
LDS5325-5530	394
LE02-3	436
LE04	435
LE05	436
LE06	439
LE07-8	437
LE09	438
LE11	437
LE12-13	438
LE14-15	440
LE16	439
LE17	440
LE18-26	434
LE28-30	435
LE31	439
LET10100A-C	115
LET1050A-C	115
LF1006LH/RH	262
LF34	262
LF5101	264
LF5102	267
LF5103	264
LF5110-115	250
LF5116-118	249
LF5121-123	272
LF5130	271
LF5260	265
LF5266	266
LF5501-3	248
LF5504-6	247
LF5507-9	249
LF55101	267
LF55102	260
LF55103	260
LF5515	272
LF5516-18	248
LF5519A-C	272
LF5524-25	256
LF5526	268

LF5527	271
LF5528A-D	269
LF5530A-C	269
LF5531-33	253-255
LF5534	258
LF5535	268
LF5536	258
LF5537	262
LF5538	255
LF5539	254
LF5539U	253
LF5540A-C	263
LF5541A-C	263
LF5542	263
LF5543	257
LF5544A-C	261
LF5545	261
LF5546	253
LF5547-48	273
LF55495	260
LF5550	252
LF5563A-C	269
LF5574A-C	266
LF5575A-B	265
LF5590	261
LF5591-92	259
LF5594	251
LF5595	252
LF56NP92	247
LFB2	406
LIP9001/LIP9001/DIN	216-217
LM5	49
LBB-LPT4004	203
LRS4000-4002	194
LRS4003	195
LRS9000-9002	207
LRS9003-9005	208
LSB5525-30	404
LSE5225-5330	386
LSS5325-5530	394
LVO2-7	442
LV11-12	443
LV13-14	444
LV19-24	441
LW02	432
LW05-7	429
LW08-9	432
LW12-13	430
LW14-17	431
LW18-23	428
LW24-26	428
LW27-29	433
LX03	427
LX04/LX04-600	424
LX05	427
LX07	425
LX12	425
LX13-14	426
LX21-25	424
M1000	156
M1001	153
M1002	148

M1003	469/485
M140NP/M140NP92	160
M219	171
M220	172
M30-31	127
M32	119
M34	152
M35	153
M35C/M35US/M35USB	154
M35RB/M34RS	155
M36A-S	165-166
M37-M38	174
M39/M39F	147
M40	180
M41	219
M42	220
M43	175
M44B-S	412
M45	175
M46	176
M47	469/490
M48	152
M51-60	170
M61	171
M63-64	127
M67-68	128
M73	417
M78	167
M86NP/M86NP92	160
MB10	176
MCN5025-30	396
ML050121-231	162
ML110921-928	167
NO-N9/NA-ND	177
NI5	49
NPH1-3	300
NUM101000-10509	115
OCP1000	116
OCP4000	200
OCP9000	212
OD8-24	231
ODE5025-30	385
ODS5025-30	395
OSE5025-30	384
OSS5025-30	396
P4.100.35	500
PAC1300-PAD1600	91
PAD4150-4600	195
PAD9150-9300	209
PAM1300	92
PAT1225-1300	92
PBC1300-PBD1600	91
PBG1250	93
PBT1225-1300	92
PCC1450-PCD1600	91
PCM1450-1600	92
PCP1000	117
PCP9000	212
PCT11200-1600	92
PE1006LH/RH	293
PE1078	493
PE1078A-C	292

INDEX

PE5	49
PE55	295
PE5501-6	287
PE55101	296
PE5520B-E	288
PE5524	295
PE5530A-B	291
PE5535	289
PE5540A-C	293
PE5541A-C	293
PE5546C/O	295
PE5550	297
PE5563A-B	291
PE5564A-B/PE5565A-B	290
PE5574	296
PE5584/BW5584	289
PE5584A-C	289
PE5590	298
PE5634	294
PE56490-9	297
PE5654	294
PE56NP92	288
PF100-102	142
PF103-105	143
PF106-107	144
PF108	141
PF109	145
PF110	145
PFC1300-PFD1300	91
PFD4225-4300	195
PFD9150-9600	209
PFT1225-1300	92
PH110/PH160	26
PH3115/PH3121	27
PH500	26
PH52	27
PL4-5	234
PLB-PLT9001	216-217
PLW/PLWCP	120
PSUA8/WHT	345
RBH1433	305
RCB8260	390
RCN8160	391
RCN8240-60	390
RCN8340-60	390/391
RCP1000	117
RCP4000	200
RCP9000	213
RDE8043/RLE8043	387
RSE8053/RSE8064	387
RSL5030	394
SAA21-22/SAA50	204
SAA23/SAA26	206
SAA28/SAA60-61	205
SAAIND	206
SCH14325/13	311
SEX1011-21	114
SEX4011-19	199
SL1-3	168
SP104/SP104L	221
SSD1415-SSF1460	88
SSK1062	106

SSL1401-3	64
SSL1404-6	65
SSL1407	66
SSM1415-SSM1460	89
SSP1405	66
SSR1405	89
SST1415/SST1415i	66
SSU1405	66
SW10	79
SW102-107	84
SW11-12	79
SW120	82
SW122-124	79
SW125-126	80
SW127	79
SW13/SW14	80
SW134	94
SW140-141	83
SW15	79
SW16-18	81
SW19	82
SW4123X	85
SWE1000/SWE1010/SWE1030	110
SWE1020/SWE1040	111
SWE1050/SWE1062	112
SWKNR1058	106
SWL1006-9	68
SWL1010	69
SWL102-3	76
SWL1121-22	69
SWL1126-31	70
SWL1132-34	71
SWL1135-61	72
SWL1162-65	73
SWL1166-68	74
SWL1190-92	75
SWL1194-96	76
SWLP123	102
SWNP11/SWNP120	107
SWNP40-41	108
SWOB-SWOU	102
SWP18/300/SWP18/600	93
SWP19/300/SWP19/600	94
SWP1134	87
SWR1137	77
SWT1016/i-SWT1025i	77
SZ500	15
SZ5004	16
SZC001-4	8
SZC010-30	6
SZC011-13	29
SZC021-23	29
SZC031-33	30
SZC040-50	7
SZC041-43	30
SZC051-53	31
SZC330	7
SZC340	8
SZM001-3	15
SZM001-3SQ/SZM004	16
SZM004SQ	17
SZM014-26	10

SZM034-36/SZM044-46	33
SZM055-57/SZM066-68	34
SZM100-130	11
SZM160-210	12
SZM210SQ/SZM220-30	13
SZM241-43	35
SZM250-370	14
SZM371-373	35
SZM380	15
SZS010NP92-030NP92LH/RH	161
SZS060-80	37
SZS12NP92LH/RH	162
SZS130/SZS350	38
SZS44B-S/SZS73	408
TC5	50
TL1-4	388
TLD5030-5850	399
TLM5030-TLS8030	400
ULE5025-30	385
ULS5025-30	398
UO5	50
URBS5025-30/URES5025-30	401
URLS5325-5530	400
UROS5025-30	401
V1005/V1005LCK	417
V1006LCK/V1008LH/RH	415
V1007LCK	416
VW5526	282
WD5	50
WF11/WF16	416
WF12B-S	412
WF13	499
WF14/WF15/WF17	414
WF21/WF35	410
WF22-25	411
WF30-32	409
WSB8125	387
XDB/XDD/XDL5760	347
XIA5000H/V	349
XIA5002-4	350
XIA5012	349
XIA5014/17	347
XID5120/XID5760V	349
XIT5120/XIT5760	349
XIT5760H/XIT5760V	349
XSA5002/03	348
XSD5760V	348
XSL5760/H/V	348
ZEE-ZEU3005	25
ZIN3003-111	19
ZIN3112-114	20
ZIN3115-117	21
ZIN3118-127	22
ZIN3129-131	23
ZIN3138-140	24
ZIN3144	25



It is our policy to distribute our products through a strong network of trade outlets namely architectural ironmongers and builders' merchants, throughout the UK. We pride ourselves on our nationwide team of knowledgeable specification and sales representatives, who are there to assist and support both our distribution network and end customers.

For information regarding the suitability of products in certain environments e.g. coastal areas and environments with high air pollution please contact our sales office on 01228 511030.

Terms and conditions are available online or upon request.

All sizes are approximate and we reserve the right to change them where necessary and without notice. Colours may vary slightly from the actual product due to photography and printing techniques. All errors and omissions excepted.



Carlisle Brass Ltd. Parkhouse Road, Carlisle, Cumbria, CA3 0JU
Sales: 01228 511030 Email: sales@carlislebrass.com Web: www.carlislebrass.com